



## FEATURES:

- SMD Package
- I/O Isolation 1500 & 3000 VDC
- Ultra Low Ripple and Noise
- Industry Standard Pinout
- Single Output Models
- Operating temperature -40°C to + 105°C
- Efficiency up to 79%
- Continuous Short Circuit Protection



## Models Single output

Model	Input Voltage (V)	Output Voltage (V)	Output Current Max   Min (mA)		Input Current Full   No Load (mA)		Isolation (VDC)	Max Capacitive Load(uF)	Efficiency (%)
AM1/4LS-0305S-NZ	2.97-3.63	5	50	5	87	20	1500	220	74
AM1/4LS-0503S-NZ	4.5-5.5	3.3	76	8	68	15	1500	220	74
AM1/4LS-0505S-NZ	4.5-5.5	5	50	5	68	15	1500	220	77
AM1/4LS-1205S-NZ	10.8-13.2	5	50	5	27	10	1500	220	75
AM1/4LS-1209S-NZ	10.8-13.2	9	28	3	27	10	1500	220	79
AM1/4LS-1212S-NZ	10.8-13.2	12	21	2	27	10	1500	220	77
AM1/4LS-2405S-NZ	21.6-26.4	5	50	5	15	8	1500	220	69
AM1/4LS-0505SH30-NZ	4.5-5.5	5	50	5	68	15	3000	220	77
AM1/4LS-1205SH30-NZ	10.8-13.2	5	50	5	27	10	3000	220	77

NOTE: All specifications in this datasheet are measured at an ambient temperature of 25°C, humidity<75%, nominal input voltage and at rated output load unless otherwise specified.

## Input Specifications

Parameters	Nominal	Typical	Maximum	Units
Voltage range	3.3	2.97-3.63		VDC
	5	4.5-5.5		
	12	10.8-13.2		
	24	21.6-26.4		
Filter	Capacitor			
Absolute Maximum Rating	3.3 Vin	-0.7-5		VDC
	5 Vin	-0.7-9		
	12 Vin	-0.7-18		
	24Vin	-0.7-30		
Peak Input Voltage time		1		s
Input Reflected Ripple Current	3.3 & 5V Input	20		mA p-p
	12 & 24 V Input	5		

## Isolation Specifications

Parameters	Conditions	Typical	Maximum	Units
Tested I/O voltage	60 sec, <1mA	1500 & 3000		VDC
Resistance	500VDC	>1000		MOhm
Capacitance		20		pF

## Output Specifications

Parameters	Conditions	Typical	Maximum	Units
Voltage accuracy	100% load (see tolerance chart)	±2.5		%
Short Circuit protection		Continuous		
Short circuit restart		Auto-Recovery		
Line voltage regulation	For ±1% of Vin	±1.5		% of Vin
Load voltage regulation	10% - 100% load	15		%
Temperature coefficient	100% load	±0.03		%/°C
Ripple & Noise	20MHz Bandwidth	20		mV p-p

### General Specifications

Parameters	Conditions	Typical	Maximum	Units
Switching frequency	100% load	100		KHz
Operating temperature	With derating above +100		-40 to +105	°C
Storage temperature			-55 to +125	°C
Cooling		Free air convection		
Humidity	Non Condensing		95	% RH
Case material		Epoxy resin (UL94-V0)		
Weight		1.5		g
Dimensions (L x W x H)		0.50 x 0.44 x 0.28 inches	12.70 x 11.20 x 7.25 mm	
MTBF		>3500K hrs (MIL-HDBK -217F, Ground Benign, t=+25°C)hours		
Maximum soldering temperature	1.5mm from case for 10 sec		300	°C
Maximum case temperature			115	°C

### Safety Specifications

Parameters	
Agency Approval	
Standards	EN55022 Class B (see recommended circuit) IEC61000-4-2, Perf. Criteria B (ESD Contact +/- 6KV)

### Pin Out Specifications and Dimensions

Pin	Single
1	- V Input
2	+ V Input
3	No Pin
4	-.V Output
5	+V Output
6	No Pin
7	No Pin
8	N.C.

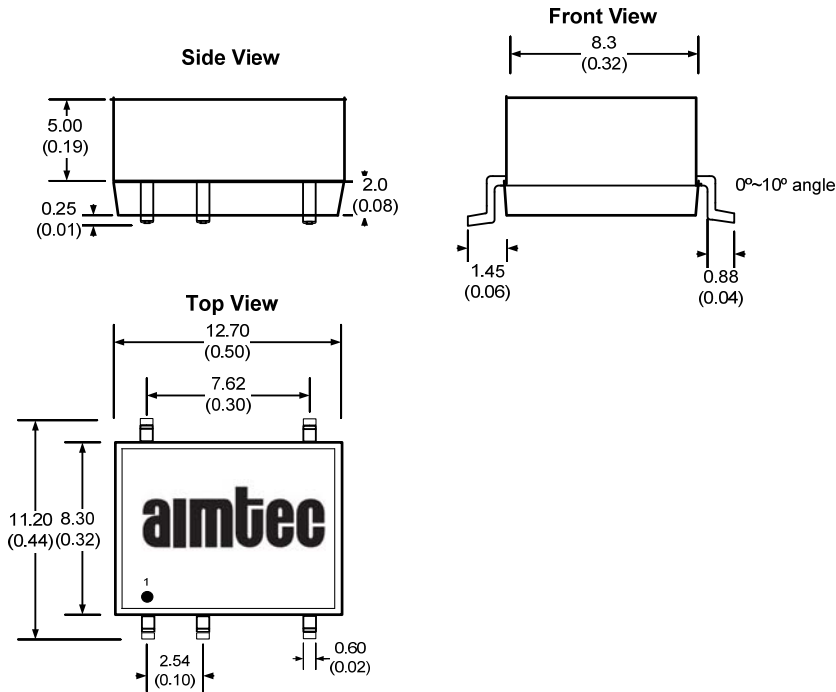

EMI Recommended Circuit (Class B)

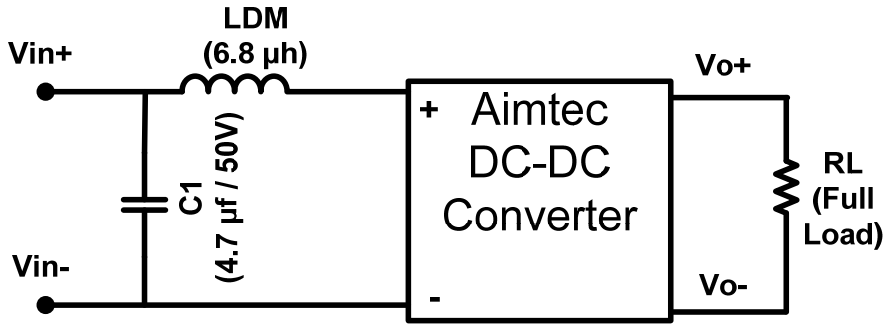

Input Reflected Ripple Current Test Circuit

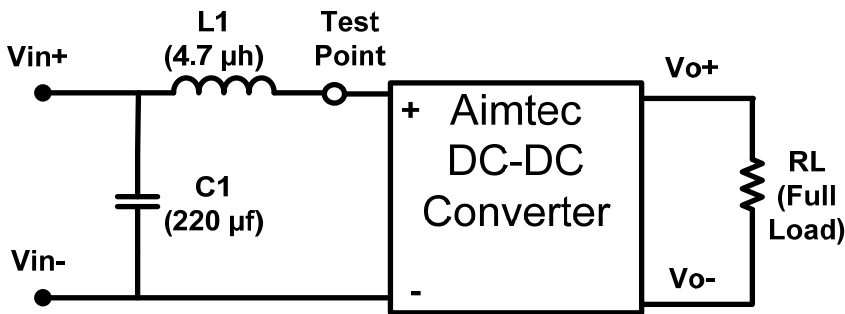

\* Tested at full load, and nominal input

Load Accuracy Tolerance Graph

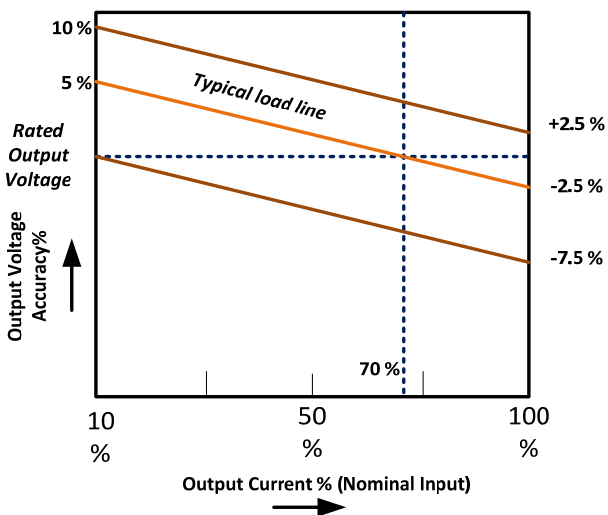

Derating

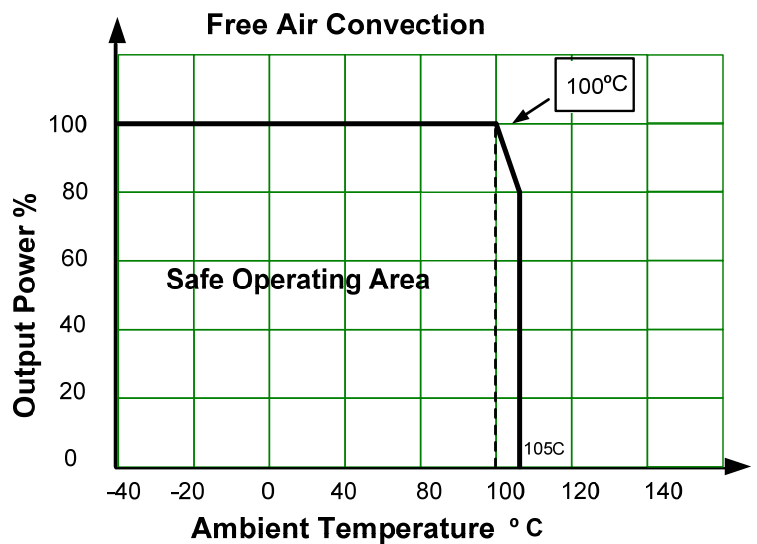

**Typical Efficiency vs. Loading**

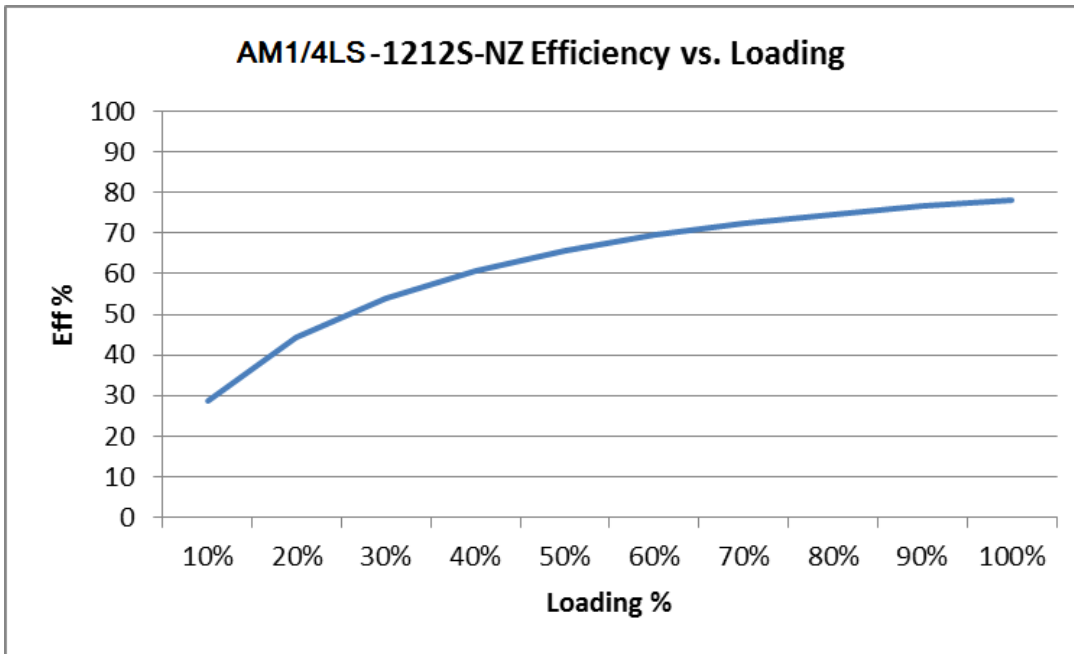
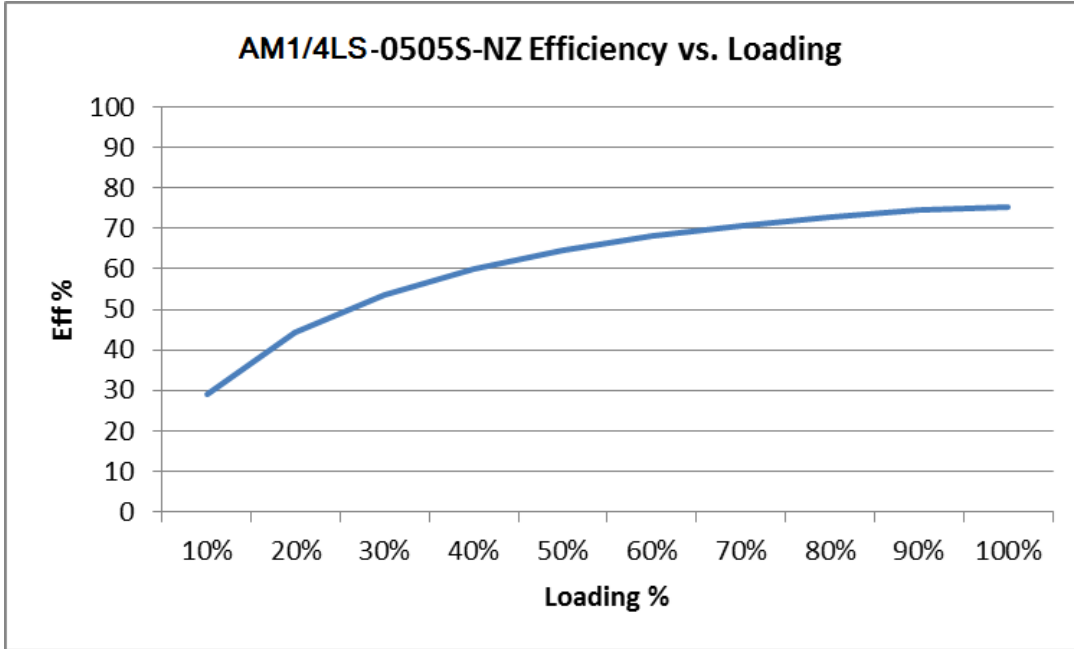

**NOTE:** **1.** Datasheets are updated as needed and as such, specifications are subject to change without notice. Once printed or downloaded, datasheets are no longer controlled by Aimtec; refer to [www.aimtec.com](http://www.aimtec.com) for the most current product specifications. **2.** Product labels shown, including safety agency certifications on labels, may vary based on the date manufactured. **3.** Mechanical drawings and specifications are for reference only. **4.** All specifications are measured at an ambient temperature of 25°C, humidity<75%, nominal input voltage and at rated output load unless otherwise specified. **5.** Aimtec may not have conducted destructive testing or chemical analysis on all internal components and chemicals at the time of publishing this document. CAS numbers and other limited information are considered proprietary and may not be available for release. **6.** This product is not designed for use in critical life support systems, equipment used in hazardous environments, nuclear control systems or other such applications which necessitate specific safety and regulatory standards other the ones listed in this datasheet. **7.** Warranty is in accordance with Aimtec's standard Terms of Sale available at [www.aimtec.com](http://www.aimtec.com).