



Reference Specification

DEC Series

Lead Type Disc Ceramic Capacitors of DC6.3kV ratings for General Purpose

Product specifications in this catalog are as of Dec. 2017, and are subject to change or obsolescence without notice.

Please consult the approval sheet before ordering. Please read rating and Cautions first.

Reference only

⚠ CAUTION

1. OPERATING VOLTAGE

When DC-rated capacitors are to be used in AC or ripple current circuits, be sure to maintain the V_{p-p} value of the applied voltage or the V_{o-p} which contains DC bias within the rated voltage range.

When the voltage is started to apply to the circuit or it is stopped applying, the irregular voltage may be generated for a transit period because of resonance or switching. Be sure to use a capacitor within rated voltage containing these irregular voltage.

When DC-rated capacitors are to be used in input circuits from commercial power source (AC filter), be sure to use Safety Recognized Capacitors because various regulations on withstand voltage or impulse withstand established for each equipment should be taken into considerations.

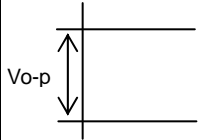
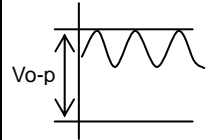
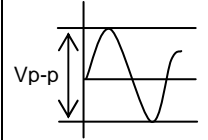
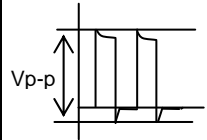
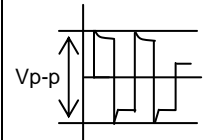
Voltage	DC Voltage	DC+AC Voltage	AC Voltage	Pulse Voltage(1)	Pulse Voltage(2)
Positional Measurement					

2. OPERATING TEMPERATURE AND SELF-GENERATED HEAT

Keep the surface temperature of a capacitor below the upper limit of its rated operating temperature range. Be sure to take into account the heat generated by the capacitor itself. When the capacitor is used in high-frequency current, pulse current or similar current, it may self-generate heat due to dielectric-loss. The frequency of the applied sine wave voltage should be less than 300kHz. The applied voltage load(*) should be such that the capacitor's self-generated heat is within 20 °C at the atmosphere temperature of 25 °C. When measuring, use a thermocouple of small thermal capacity-K of $\phi 0.1\text{mm}$ in conditions where the capacitor is not affected by radiant heat from other components or surrounding ambient fluctuations. Excessive heat may lead to deterioration of the capacitor's characteristics and reliability. (Never attempt to perform measurement with the cooling fan running. Otherwise, accurate measurement cannot be ensured.)

* Before using SL characteristic capacitor (low dissipation), be sure to read the instructions in item 4.

3. FAIL-SAFE

When capacitor would be broken, failure may result in a short circuit. Be sure to provide an appropriate fail-safe function like a fuse on your product if failure would follow an electric shock, fire or fume.

4. LOAD REDUCTION AND SELF-GENERATED HEAT DURING APPLICATION OF HIGH-FREQUENCY AND HIGH-VOLTAGE

In the case of SL characteristic capacitors, due to the low self-heating characteristics of low-dissipation capacitor, the allowable electric power is much higher than the general B characteristic. However, in case the self-heating temperature is 20 °C under a high-frequency voltage whose peak-to-peak value equals the

capacitors rated voltage, the capacitors power consumption may exceeded it's allowable electric power. Therefore, when using the SL characteristic capacitors in a high-frequency and high-voltage circuit with a frequency of 1kHz or higher, make sure that the Vp-p values including the DC bias, do not exceed the applied voltage value specified in Table 1. Also make sure that the self-heating temperature (the difference between the capacitor's surface temperature and the capacitor's ambient temperature) at an ambient temperature of 25 °C does not exceed the value specified in Table 1.

As shown in Fig. 1, the self-heating temperature depends on the ambient temperature. Therefore, if you are not able to set the ambient temperature to approximately 25 °C, please contact our sales representatives or product engineers.

<Table 1> Allowable Conditions at High-frequency

Temp. Char.	DC Rated Voltage	Allowable Conditions at High-frequency *3		Capacitor's Ambient Temp. *2
		Applied Voltage (max.)	Self-heating Temp. (25 °C Ambient Temp.) *1	
SL	6.3kV	6300Vp-p	5 °C max.	-25 to +85 °C

*1 When the ambient temperature is 85 to 125 °C, the applied voltage needs to be further reduced.

If the low-dissipation capacitors need to be used at an ambient temperature of 85 to 125 °C, please contact our sales representatives or product engineers.

*2 Fig. 2 shows reference data on the allowable voltage-frequency characteristic for a sine wave voltage.

<Fig. 1> Dependence of Self-heating Temperature on Ambient Temperature

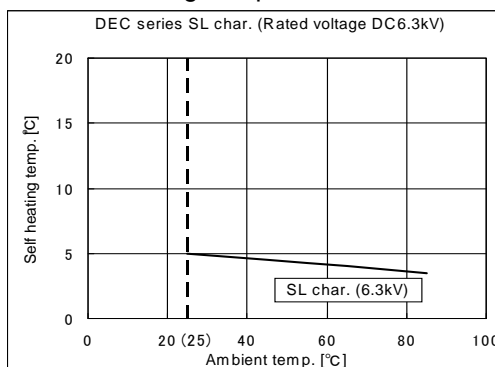

<Fig. 2> Allowable Voltage (Sine Wave Voltage) – Frequency Characteristic [At Ambient Temperature of 85 °C or less]

Because of the influence of harmonics, when the applied voltage is a rectangular wave or pulse wave voltage (instead of a sine wave voltage), the heat generated by the capacitor is higher than the value obtained by application of the sine wave with the same fundamental frequency. Roughly calculated for reference, the allowable voltage for a rectangular wave or pulse wave corresponds approximately to the allowable voltage for a sine wave whose fundamental frequency is twice as large as that of the rectangular wave or pulse wave. This allowable voltage, however, varies depending on the voltage and current waveforms. Therefore, you are requested to make sure that the self-heating temperature is not higher than the value specified in Table 1.

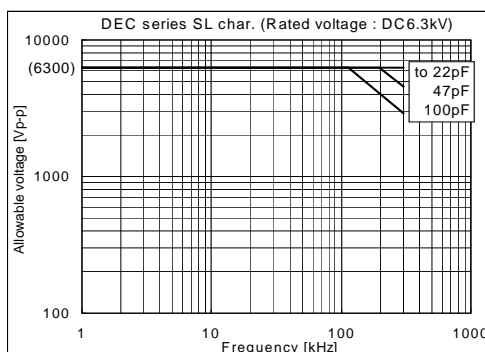

Reference only

5. VIBRATION AND IMPACT

Do not expose a capacitor or its leads to excessive shock or vibration during use.

6. SOLDERING

When soldering this product to a PCB/PWB, do not exceed the solder heat resistance specification of the capacitor. Subjecting this product to excessive heating could melt the internal junction solder and may result in thermal shocks that can crack the ceramic element.

When soldering capacitor with a soldering iron, it should be performed in following conditions.

Temperature of iron chip : 400 °C max.

Soldering iron wattage : 50 W max.

Soldering time : 3.5 s max.

7. BONDING, RESIN MOLDING AND COATING

In case of bonding, molding or coating this product, verify that these processes do not affect the quality of capacitor by testing the performance of the bonded, molded or coated product in the intended equipment.

In case of the amount of applications, dryness / hardening conditions of adhesives and molding resins containing organic solvents (ethyl acetate, methyl ethyl ketone, toluene, etc.) are unsuitable, the outer coating resin of a capacitor is damaged by the organic solvents and it may result, worst case, in a short circuit.

The variation in thickness of adhesive, molding resin or coating may cause a outer coating resin cracking and/or ceramic element cracking of a capacitor in a temperature cycling.

8. TREATMENT AFTER BONDING, RESIN MOLDING AND COATING

When the outer coating is hot (over 100 °C) after soldering, it becomes soft and fragile.

So please be careful not to give it mechanical stress.

Failure to follow the above cautions may result, worst case, in a short circuit and cause fuming or partial dispersion when the product is used.

9. OPERATING AND STORAGE ENVIRONMENT

The insulating coating of capacitors does not form a perfect seal; therefore, do not use or store capacitors

in a corrosive atmosphere, especially where chloride gas, sulfide gas, acid, alkali, salt or the like are present. And avoid exposure to moisture. Before cleaning, bonding, or molding this product, verify that these processes do not affect product quality by testing the performance of a cleaned, bonded or molded product in the intended equipment. Store the capacitors where the temperature and relative humidity do not exceed -10 to 40 °C and 15 to 85%. Use capacitors within 6 months after delivered.

Check the solderability after 6 months or more.

10. LIMITATION OF APPLICATIONS

Please contact us before using our products for the applications listed below which require especially high reliability for the prevention of defects which might directly cause damage to the third party's life, body or property.

1. Aircraft equipment
2. Aerospace equipment
3. Undersea equipment
4. Power plant control equipment
5. Medical equipment
6. Transportation equipment (vehicles, trains, ships, etc.)
7. Traffic signal equipment
8. Disaster prevention / crime prevention equipment
9. Data-processing equipment exerting influence on public
10. Application of similar complexity and/or reliability requirements to the applications listed in the above.

NOTICE

1. CLEANING (ULTRASONIC CLEANING)

To perform ultrasonic cleaning, observe the following conditions.

Rinse bath capacity : Output of 20 watts per liter or less.

Rinsing time : 5 min maximum.

Do not vibrate the PCB/PWB directly.

Excessive ultrasonic cleaning may lead to fatigue destruction of the lead wires.

2. CAPACITANCE CHANGE OF CAPACITORS

- Class 1 capacitors

Capacitance might change a little depending on a surrounding temperature or an applied voltage.

Please contact us if you use for the strict time constant circuit.

- Class 2 and 3 capacitors

Class 2 and 3 capacitors like temperature characteristic B, E and F have an aging characteristic, whereby the capacitor continually decreases its capacitance slightly if the capacitor leaves for a long time.

Moreover, capacitance might change greatly depending on a surrounding temperature or an applied voltage. So, it is not likely to be able to use for the time constant circuit.

Please contact us if you need a detail information.

 **NOTE**

1. Please make sure that your product has been evaluated in view of your specifications with our product being mounted to your product.

2. You are requested not to use our product deviating from this specification.

Reference only

1. Application

This specification is applied to Lead Type Disc Ceramic Capacitors of DC6.3 kV ratings and Class1,2 of DEC series used for General Electric equipment.

Do not use these products in any automotive power train or safety equipment including battery chargers for electric vehicles and plug-in hybrids.

2. Rating

2-1. Operating temperature range

-25 ~ +85°C

2-2. Part number configuration

ex.) DEC B3 3J 102 K C4 B _____
 Series Temperature Rated Capacitance Capacitance Lead Packing Individual
 characteristic voltage tolerance code style code specification

- Temperature characteristic

Code	Temperature characteristic
1X	SL
B3	B
E3	E

Please confirm detailed specification on [Specification and test methods].

- Rated voltage

Code	Rated voltage
3J	DC6.3kV

- Capacitance

The first two digits denote significant figures ; the last digit denotes the multiplier of 10 in pF.

ex.) In case of 102.

$$10 \times 10^2 = 1000\text{pF}$$

- Capacitance tolerance

Please refer to [Part number list].

- Lead code

Code	Lead style
A*	Vertical crimp long type
C*	Straight long type

* Please refer to [Part number list].

Solder coated copper wire is applied for termination.

- Packing style code

Code	Packing type
B	Bulk type

- Individual specification

In case part number cannot be identified without 'individual specification' , it is added at the end of part number.

Reference only

3. Marking

Temperature characteristic	: Letter code (Omitted for char. SL, char. E and maximum body diameter ϕ 9mm and under of char. B.)						
Nominal capacitance	: Actual value (under 100pF) 3 digit system (100pF and over)						
Capacitance tolerance	: Code						
Rated voltage	: Letter code (In case of DC6.3kV marked with 6KV)						
Company name code	: Abbreviation  (Omitted for maximum body diameter ϕ 9mm and under)						
Manufacturing year	: Letter code(The last digit of A.D. year.) (Omitted for maximum body diameter ϕ 7mm and under)						
Manufacturing month	: Code(Omitted for maximum body diameter ϕ 7mm and under) <table border="1"><tr><td>Feb./Mar. \rightarrow 2</td><td>Aug./Sep. \rightarrow 8</td></tr><tr><td>Apr./May \rightarrow 4</td><td>Oct./Nov. \rightarrow O</td></tr><tr><td>Jun./Jul. \rightarrow 6</td><td>Dec./Jan. \rightarrow D</td></tr></table>	Feb./Mar. \rightarrow 2	Aug./Sep. \rightarrow 8	Apr./May \rightarrow 4	Oct./Nov. \rightarrow O	Jun./Jul. \rightarrow 6	Dec./Jan. \rightarrow D
Feb./Mar. \rightarrow 2	Aug./Sep. \rightarrow 8						
Apr./May \rightarrow 4	Oct./Nov. \rightarrow O						
Jun./Jul. \rightarrow 6	Dec./Jan. \rightarrow D						

(Example)

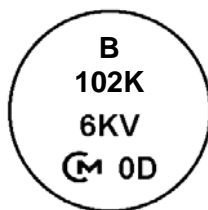

Reference only

4. Part number list

·Vertical crimp long type
(Lead code:A*)

·Straight long type
(Lead code:C*)

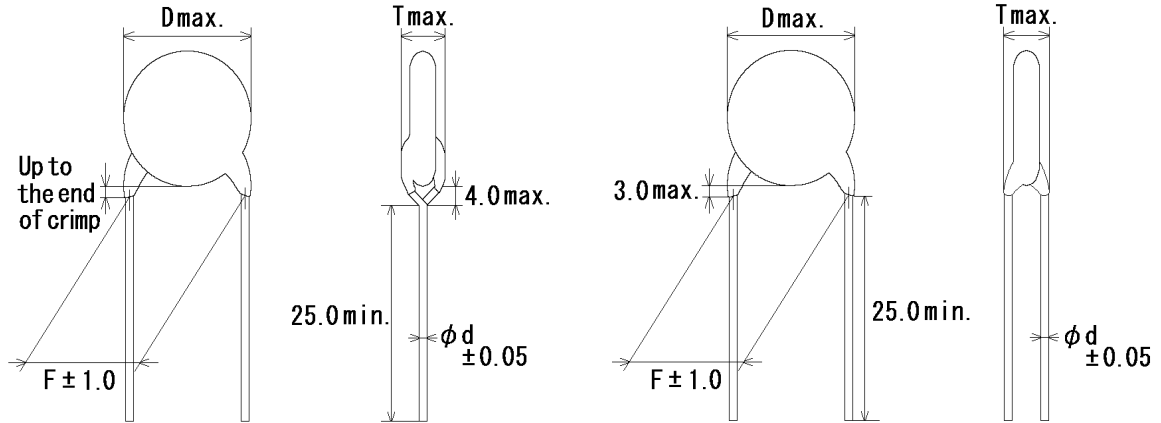

Note) The mark '*' of lead code differ from lead spacing(F) and lead diameter(d). Please see the following list about details.

Unit : mm

T.C.	Cap. (pF)	Cap. tol.	Customer Part Number	Murata Part Number	DC Rated Volt. (V)	Dimension (mm)				Lead Code	Pack qty. (pcs)
						D	T	F	d		
SL	10	±5%		DEC1X3J100JA3BMS1	6300	7.0	7.0	7.5	0.6	A3	250
SL	10	±5%		DEC1X3J100JC4BMS1	6300	7.0	7.0	10.0	0.6	C4	250
SL	12	±5%		DEC1X3J120JA3B	6300	8.0	7.0	7.5	0.6	A3	250
SL	12	±5%		DEC1X3J120JC4B	6300	8.0	7.0	10.0	0.6	C4	250
SL	15	±5%		DEC1X3J150JA3B	6300	8.0	7.0	7.5	0.6	A3	250
SL	15	±5%		DEC1X3J150JC4B	6300	8.0	7.0	10.0	0.6	C4	250
SL	18	±5%		DEC1X3J180JA3B	6300	9.0	7.0	7.5	0.6	A3	250
SL	18	±5%		DEC1X3J180JC4B	6300	9.0	7.0	10.0	0.6	C4	250
SL	22	±5%		DEC1X3J220JA3B	6300	9.0	7.0	7.5	0.6	A3	250
SL	22	±5%		DEC1X3J220JC4B	6300	9.0	7.0	10.0	0.6	C4	250
SL	27	±5%		DEC1X3J270JA3B	6300	9.0	7.0	7.5	0.6	A3	250
SL	27	±5%		DEC1X3J270JC4B	6300	9.0	7.0	10.0	0.6	C4	250
SL	33	±5%		DEC1X3J330JA3B	6300	9.0	7.0	7.5	0.6	A3	250
SL	33	±5%		DEC1X3J330JC4B	6300	9.0	7.0	10.0	0.6	C4	250
SL	39	±5%		DEC1X3J390JA3B	6300	9.0	7.0	7.5	0.6	A3	250
SL	39	±5%		DEC1X3J390JC4B	6300	9.0	7.0	10.0	0.6	C4	250
SL	47	±5%		DEC1X3J470JA3B	6300	9.0	7.0	7.5	0.6	A3	250
SL	47	±5%		DEC1X3J470JC4B	6300	9.0	7.0	10.0	0.6	C4	250
SL	56	±5%		DEC1X3J560JC4B	6300	10.0	7.0	10.0	0.6	C4	100
SL	68	±5%		DEC1X3J680JC4B	6300	12.0	7.0	10.0	0.6	C4	100
SL	82	±5%		DEC1X3J820JC4B	6300	12.0	7.0	10.0	0.6	C4	100
SL	100	±5%		DEC1X3J101JC4B	6300	13.0	7.0	10.0	0.6	C4	100
SL	120	±5%		DEC1X3J121JC4B	6300	14.0	7.0	10.0	0.6	C4	100
SL	150	±5%		DEC1X3J151JC4B	6300	15.0	7.0	10.0	0.6	C4	100
B	100	±10%		DECB33J101KC4B	6300	9.0	7.0	10.0	0.6	C4	250
B	150	±10%		DECB33J151KC4B	6300	9.0	7.0	10.0	0.6	C4	250
B	220	±10%		DECB33J221KC4B	6300	9.0	7.0	10.0	0.6	C4	250

Reference only

•Straight long type
(Lead code: C*)

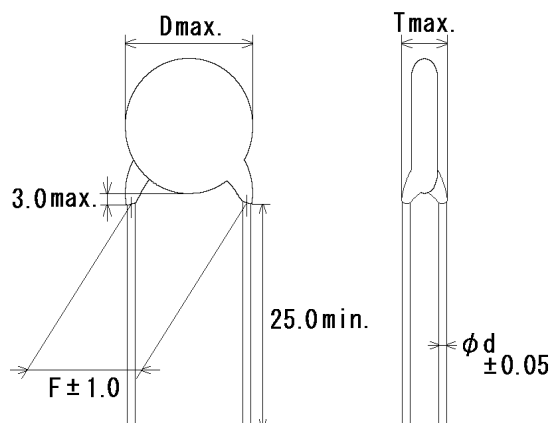

Note) The mark '*' of lead code differ from lead spacing(F) and lead diameter(d).
Please see the following list about details.

Unit : mm

T.C.	Cap. (pF)	Cap. tol.	Customer Part Number	Murata Part Number	DC Rated Volt. (V)	Dimension (mm)				Lead Code	Pack qty. (pcs)
						D	T	F	d		
B	330	±10%		DECB33J331KC4B	6300	9.0	7.0	10.0	0.6	C4	250
B	470	±10%		DECB33J471KC4B	6300	10.0	7.0	10.0	0.6	C4	100
B	680	±10%		DECB33J681KC4B	6300	11.0	7.0	10.0	0.6	C4	100
B	1000	±10%		DECB33J102KC4B	6300	13.0	7.0	10.0	0.6	C4	100
E	1000	+80/-20%		DECE33J102ZC4B	6300	11.0	7.0	10.0	0.6	C4	100
E	2200	+80/-20%		DECE33J222ZC4B	6300	15.0	7.0	10.0	0.6	C4	100

Reference only

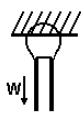
5. Specification and test methods															
No.	Item	Specification	Test method												
1	Appearance and dimensions	No marked defect on appearance form and dimensions. Please refer to [Part number list].	The capacitor should be inspected by naked eyes for visible evidence of defect. Dimensions should be measured with slide calipers.												
2	Marking	To be easily legible.	The capacitor should be inspected by naked eyes.												
3	Dielectric strength	Between lead wires No failure.	The capacitor should not be damaged when DC voltage of 200% of the rated voltage are applied between the lead wires for 1 to 5 s. (Charge/Discharge current ≤ 50mA.)												
		Body insulation No failure.	The capacitor is placed in the container with metal balls of diameter 1mm so that each lead wire, shortcircuited, is kept about 2mm off the balls as shown in the figure, and DC voltage of 1.3kV is applied for 1 to 5 s between capacitor lead wires and small metals. (Charge/Discharge current ≤ 50mA.)												
4	Insulation Resistance (I.R.)	Between lead wires 10 000MΩ min.	The insulation resistance should be measured with DC500±50V within 60±5 s of charging.												
5	Capacitance	Within specified tolerance.	The capacitance should be measured at 20°C with 1±0.2kHz (Char. SL : 1±0.2MHz) and AC5V(r.m.s.) max..												
6	Q	Char. SL : 400+20C*2min. (30pF under) 1000 min. (30pF min.)	The dissipation factor and Q should be measured at 20°C with 1±0.2kHz (Char. SL : 1±0.2MHz) and AC5V(r.m.s.) max..												
	Dissipation Factor (D.F.)	Char. B,E : 2.5% max.													
7	Temperature characteristic	Char. SL : +350 to - 1 000ppm/°C (Temp. range: +20 to 85°C) Char. B : Within ±10 % Char. E : Within +20/-55%	The capacitance measurement should be made at each step specified in Table.												
		Pre-treatment : Capacitor should be stored at 85±2°C for 1 h, then placed at *1room condition for 24±2 h before initial measurements. (Char. B,E)													
<table border="1" style="margin: auto;"> <thead> <tr> <th>Step</th> <th>1</th> <th>2</th> <th>3</th> <th>4</th> <th>5</th> </tr> </thead> <tbody> <tr> <td>Temp.(°C)</td> <td>20±2</td> <td>-25±3</td> <td>20±2</td> <td>85±2</td> <td>20±2</td> </tr> </tbody> </table>				Step	1	2	3	4	5	Temp.(°C)	20±2	-25±3	20±2	85±2	20±2
Step	1	2	3	4	5										
Temp.(°C)	20±2	-25±3	20±2	85±2	20±2										
8	Strength of lead	Pull Lead wire should not cut off. Capacitor should not be broken.	As shown in the figure at right, fix the body of the capacitor and apply a tensile weight gradually to each lead wire in the radial direction of the capacitor up to 10N and keep it for 10±1 s.  Each lead wire should be subjected to 5N of weight and bent 90° at the point of egress, in one direction, then returned to its original position and bent 90° in the opposite direction at the rate of one bend in 2 to 3 s.												
		Bending													
9	Vibration resistance	Appearance No marked defect.	The capacitor should be firmly soldered to the supporting lead wire and vibrated at a frequency range of 10 to 55Hz, 1.5mm in total amplitude, with about a 1min rate of vibration change from 10Hz to 55Hz and back to 10Hz. Apply for a total of 6 h; 2 h each in 3 mutually perpendicular directions.												
		Capacitance Within specified tolerance.													
		Q Char. SL : 400+20C*2min. (30pF under) 1 000 min. (30pF min.)													
	D.F. Char. B,E : 2.5% max.														
10	Solderability of leads	Lead wire should be soldered with uniformly coated on the axial direction over 3/4 of the circumferential direction.	The lead wire of a capacitor should be dipped into a ethanol solution of 25wt% rosin and then into molten solder for 2±0.5 s. In both cases the depth of dipping is up to about 1.5 to 2mm from the root of lead wires. Temp. of solder : 245±5°C Lead Free Solder (Sn-3Ag-0.5Cu) 235±5°C H63 Eutectic Solder												
<p>*1 "room condition" Temperature: 15 to 35°C, Relative humidity: 45 to 75%, Atmospheric pressure: 86 to 106kPa *2 "C" expresses nominal capacitance value (pF)</p>															

Reference only

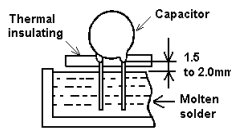
No.	Item	Specification	Test method	
11	Soldering effect (Non-preheat)	Appearance	The lead wire should be immersed into the melted solder of 350±10°C up to about 1.5 to 2.0mm from the main body for 3.5±0.5 s. Pre-treatment : Capacitor should be stored at 85±2°C for 1 h, then placed at *1room condition for 24±2 h before initial measurements. (Char. B,E) Post-treatment : Capacitor should be stored for 1 to 2 h at *1room condition. (Char. SL) Post-treatment : Capacitor should be stored for 4 to 24 h at *1room condition. (Char. B,E)	
		Capacitance change		Char. SL : Within ± 2.5% Char. B : Within ± 5% Char. E : Within ± 15%
12	Soldering effect (On-preheat)	Appearance	First the capacitor should be stored at 120+0/-5°C for 60+0/-5 s. Then, as in figure, the lead wires should be immersed solder of 260+0/-5°C up to 1.5 to 2.0mm from the root of terminal for 7.5+0/-1 s.  Pre-treatment : Capacitor should be stored at 85±2°C for 1 h, then placed at *1room condition for 24±2 h before initial measurements. (Char. B,E) Post-treatment : Capacitor should be stored for 1 to 2 h at *1room condition. (Char. SL) Post-treatment : Capacitor should be stored for 4 to 24 h at *1room condition. (Char. B,E)	
		Capacitance change		Char. SL : Within ± 2.5% Char. B : Within ± 5% Char. E : Within ± 15%
13	Humidity (Under steady state)	Appearance	Set the capacitor for 500 +24/-0 h at 40±2°C in 90 to 95% relative humidity. Pre-treatment : Capacitor should be stored at 85±2°C for 1 h, then placed at *1room condition for 24±2 h before initial measurements. (Char. B,E) Post-treatment : Capacitor should be stored for 1 to 2 h at *1room condition.	
		Capacitance change		Char. SL : Within ± 5% Char. B : Within ±10% Char. E : Within ±20%
14	Humidity loading	Q	Apply the rated voltage for 500 +24/-0 h at 40±2°C in 90 to 95% relative humidity. (Charge/Discharge current≤50mA.) Pre-treatment : Capacitor should be stored at 85±2°C for 1 h, then placed at *1room condition for 24±2 h before initial measurements. (Char. B,E) Post-treatment : Capacitor should be stored for 1 to 2 h at *1room condition. (Char. SL) Post-treatment : Capacitor should be stored at 85±2°C for 1 h, then placed at *1room condition for 24±2 h. (Char. B,E)	
		D.F.		Char. SL : 275+5/2C*2min. (30pF under) 350 min. (30pF min.)
		I.R.		Char. B,E : 5.0% max.
		I.R.		1 000MΩ min.
14	Humidity loading	Appearance	Apply the rated voltage for 500 +24/-0 h at 40±2°C in 90 to 95% relative humidity. (Charge/Discharge current≤50mA.) Pre-treatment : Capacitor should be stored at 85±2°C for 1 h, then placed at *1room condition for 24±2 h before initial measurements. (Char. B,E) Post-treatment : Capacitor should be stored for 1 to 2 h at *1room condition. (Char. SL) Post-treatment : Capacitor should be stored at 85±2°C for 1 h, then placed at *1room condition for 24±2 h. (Char. B,E)	
		Capacitance change		Char. SL : Within ± 7.5% Char. B : Within ±10% Char. E : Within ±20%
		Q		Char. SL : 100+10/3C*2min. (30pF under) 200 min. (30pF min.)
		I.R.		Char. B,E : 5.0% max. 500MΩ min.

*1 "room condition" Temperature: 15 to 35°C, Relative humidity: 45 to 75%, Atmospheric pressure: 86 to 106kPa

*2 "C" expresses nominal capacitance value (pF)

Reference only

No.	Item	Specification	Test method																											
15	Life	Appearance	No marked defect.																											
		Capacitance change	Char. SL : Within $\pm 3\%$ Char. B : Within $\pm 10\%$ Char. E : Within $\pm 20\%$																											
		Q	Char. SL : $275+5/2C^*2\text{min. (30pF under)}$ $350\text{ min. (30pF min.)}$																											
		D.F.	Char. B,E : 4.0% max.																											
		I.R.	2000M Ω min.																											
			Apply a DC voltage of 150% of the rated voltage for 1 000 +48/-0 h at 85 $\pm 2^\circ\text{C}$, and relative humidity of 50% max.. (Charge/Discharge current $\leq 50\text{mA}$.) Pre-treatment : Capacitor should be stored at 85 $\pm 2^\circ\text{C}$ for 1 h, then placed at *1room condition for 24 ± 2 h before initial measurements. (Char. B,E) Post-treatment : Capacitor should be stored for 1 to 2 h at *1room condition. (Char. SL) Post-treatment : Capacitor should be stored at 85 $\pm 2^\circ\text{C}$ for 1 h, then placed at *1room condition for 24 ± 2 h. (Char. B,E)																											
16	Temperature and Immersion cycle	Appearance	No marked defect.																											
		Capacitance change	Char. SL : Within $\pm 3\%$ Char. B : Within $\pm 10\%$ Char. E : Within $\pm 20\%$																											
		Q	Char. SL : $275+5/2C^*2\text{min. (30pF under)}$ $350\text{ min. (30pF min.)}$																											
		D.F.	Char. B,E : 4.0% max.																											
		I.R.	2000M Ω min.																											
		Dielectric strength (Between lead wires)	Per item 3.																											
			The capacitor should be subjected to 5 temperature cycles, then consecutively to 2 immersion cycles. <Temperature cycle> <table border="1"> <thead> <tr> <th>Step</th> <th>Temperature($^\circ\text{C}$)</th> <th>Time</th> </tr> </thead> <tbody> <tr> <td>1</td> <td>-25± 3</td> <td>30 min</td> </tr> <tr> <td>2</td> <td>Room Temp.</td> <td>3 min</td> </tr> <tr> <td>3</td> <td>+85± 3</td> <td>30 min</td> </tr> <tr> <td>4</td> <td>Room Temp.</td> <td>3 min</td> </tr> </tbody> </table> <p align="right">Cycle time : 5 cycle</p> <Immersion cycle> <table border="1"> <thead> <tr> <th>Step</th> <th>Temperature($^\circ\text{C}$)</th> <th>Time</th> <th>Immersion water</th> </tr> </thead> <tbody> <tr> <td>1</td> <td>+65+5/-0</td> <td>15 min</td> <td>Clean water</td> </tr> <tr> <td>2</td> <td>0± 3</td> <td>15 min</td> <td>Salt water</td> </tr> </tbody> </table> <p align="right">Cycle time : 2 cycle</p> Pre-treatment : Capacitor should be stored at 85 $\pm 2^\circ\text{C}$ for 1 h, then placed at *1room condition for 24 ± 2 h before initial measurements. (Char. B,E) Post-treatment : Capacitor should be stored for 4 to 24 h at *1room condition.	Step	Temperature($^\circ\text{C}$)	Time	1	-25 ± 3	30 min	2	Room Temp.	3 min	3	+85 ± 3	30 min	4	Room Temp.	3 min	Step	Temperature($^\circ\text{C}$)	Time	Immersion water	1	+65+5/-0	15 min	Clean water	2	0 ± 3	15 min	Salt water
Step	Temperature($^\circ\text{C}$)	Time																												
1	-25 ± 3	30 min																												
2	Room Temp.	3 min																												
3	+85 ± 3	30 min																												
4	Room Temp.	3 min																												
Step	Temperature($^\circ\text{C}$)	Time	Immersion water																											
1	+65+5/-0	15 min	Clean water																											
2	0 ± 3	15 min	Salt water																											

*1 "room condition" Temperature: 15 to 35 $^\circ\text{C}$, Relative humidity: 45 to 75%, Atmospheric pressure: 86 to 106kPa

*2 "C" expresses nominal capacitance value (pF)

Reference only

6. Packing specification

- Bulk type (Packing style code : B)

The size of packing case and packing way

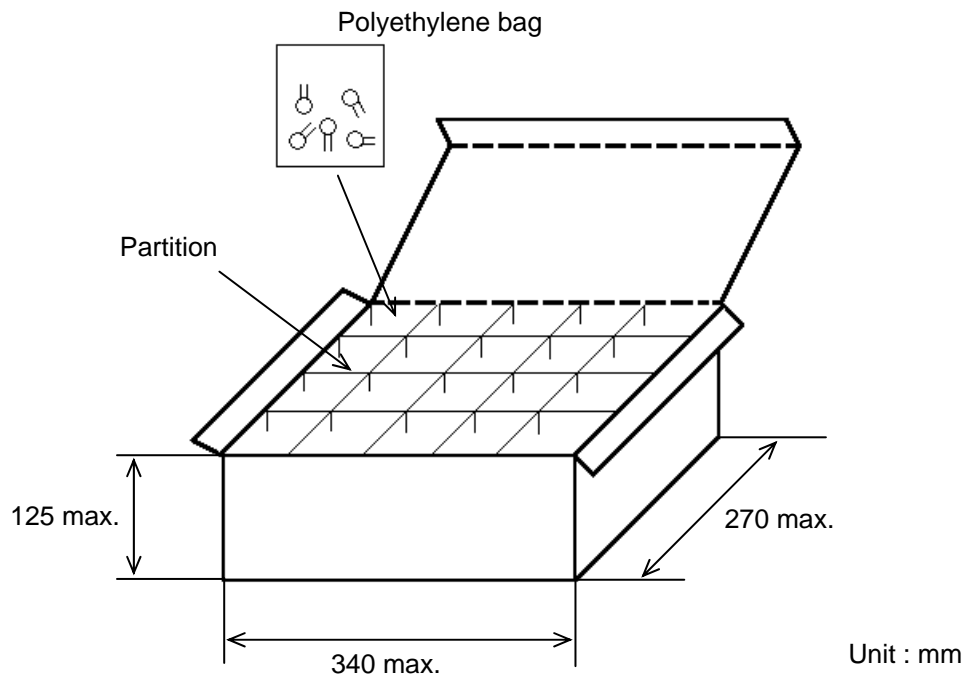

The number of packing = ^{*1} Packing quantity × ^{*2} n

*1 : Please refer to [Part number list].

*2 : Standard n = 20 (bag)

Note)

The outer package and the number of outer packing be changed by the order getting amount.

EU RoHS
RoHS指令への対応

This products of the following crresponds to EU RoHS
当製品は以下の欧州RoHSに対応しています。

(1) RoHS

EU RoHs 2011/65/EC compliance
2011/65/EC(改正RoHS指令)に対応

maximum concentration values tolerated by weight in homogeneous materials

- ・1000 ppm maximum Lead
- ・1000 ppm maximum Mercury
- ・100 ppm maximum Cadmium
- ・1000 ppm maximum Hexavalent chromium
- ・1000 ppm maximum Polybrominated biphenyls (PBB)
- ・1000 ppm maximum Polybrominated diphenyl ethers (PBDE)

鉛:1000ppm以下

水銀:1000ppm以下

カドミウム:100ppm以下

六価クロム:1000ppm以下

ポリ臭化ビフェニル(PBB):1000ppm以下

ポリ臭化ジフェニルエーテル(PBDE):1000ppm以下