

LQG15HS1N3S02#

indicates a package specification code.



< List of part numbers with package codes >
 LQG15HS1N3S02D , LQG15HS1N3S02J , LQG15HS1N3S02B

Shape

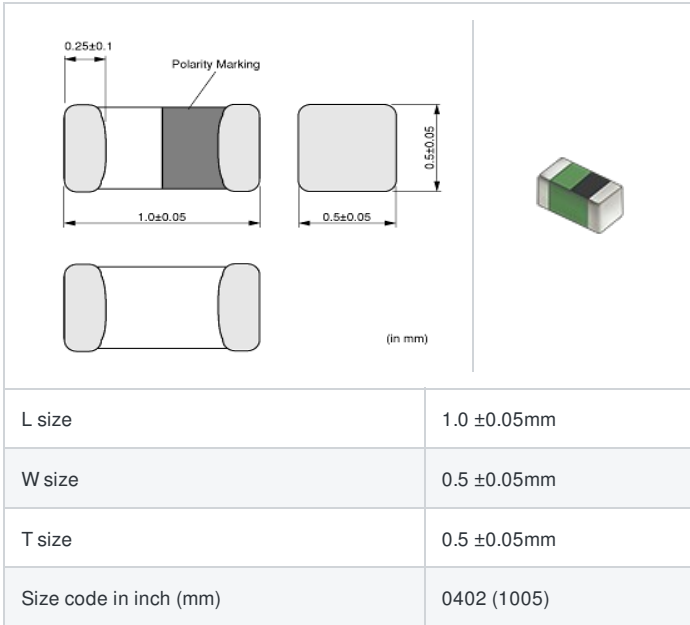

References

Packaging code	Specifications	Minimum quantity
D	φ180mm Paper taping	10000
J	φ330mm Paper taping	50000
B	Packing in bulk	1000

Mass (Typ.)	
1 piece	0.001g

Specifications

Inductance	1.3nH ±0.3nH
Inductance test frequency	100MHz
Rated current (Itemp) (Based on Temperature rise)	1000mA
Max. of DC resistance	0.07Ω
Q (min.)	8
Q test frequency	100MHz
Self resonance frequency (min.)	6000MHz
Operating temperature range (Self-temperature rise is not included)	-55~125°C
Series	LQG15HS_02

Attention

- 1.This datasheet is downloaded from the website of Murata Manufacturing Co., Ltd. Therefore, it's specifications are subject to change or our products in it may be discontinued without advance notice. Please check with our sales representatives or product engineers before ordering.
- 2.This datasheet has only typical specifications because there is no space for detailed specifications. Therefore, please review our product specifications or consult the approval sheet for product specifications before ordering.

Chart of characteristic data (The charts below may show another part number which shares its characteristics.)

▪ Inductance-Frequency characteristics (Typ.)

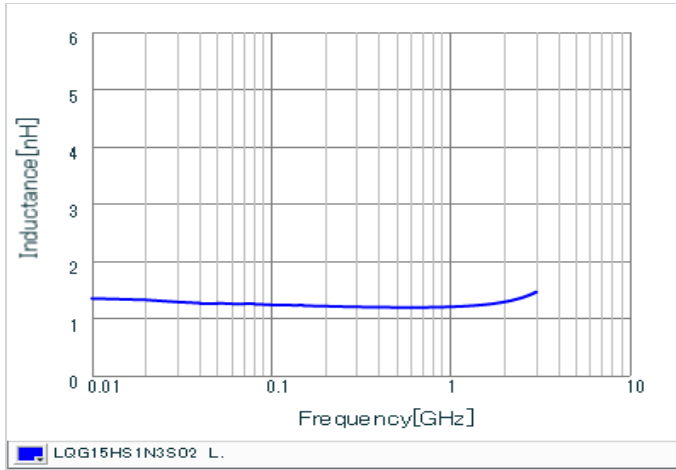

▪ Q-Frequency characteristics (Typ.)

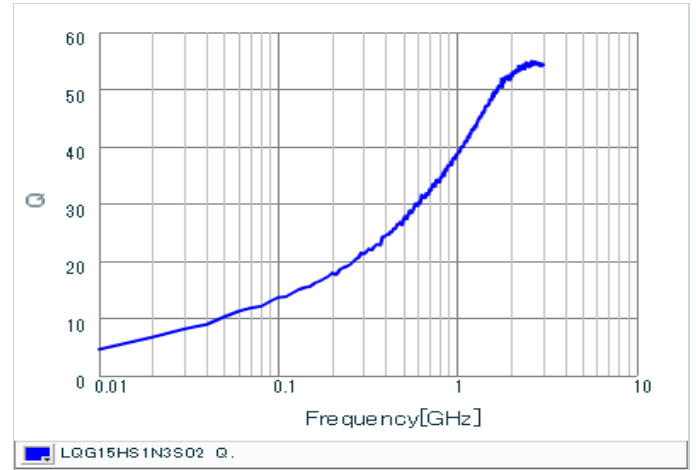

⚠ Attention

- 1.This datasheet is downloaded from the website of Murata Manufacturing Co., Ltd. Therefore, it's specifications are subject to change or our products in it may be discontinued without advance notice. Please check with our sales representatives or product engineers before ordering.
- 2.This datasheet has only typical specifications because there is no space for detailed specifications.
Therefore, please review our product specifications or consult the approval sheet for product specifications before ordering.