

Overview

KEMET's X7R dielectric features a 125°C maximum operating temperature and is considered temperature stable. The Electronics Components, Assemblies and Materials Association (EIA) characterizes X7R dielectric as a Class II material. Components of this classification are fixed, ceramic dielectric capacitors suited for bypass and decoupling applications or for frequency discriminating

circuits where Q and stability of capacitance characteristics are not critical. X7R exhibits a predictable change in capacitance with respect to time and voltage, boasting a minimal change in capacitance with reference to ambient temperature. Capacitance change is limited to $\pm 15\%$ from -55°C to $+125^{\circ}\text{C}$.

Benefits

- -55°C to $+125^{\circ}\text{C}$ operating temperature range
- Lead (Pb)-free, RoHS, and REACH Compliant
- Temperature stable dielectric
- EIA 0402, 0603, 0805, 1206, 1210, 1808, 1812, 1825, 2220, and 2225 case sizes
- DC voltage ratings of 6.3 V, 10 V, 16 V, 25 V, 35 V, 50 V, 100 V, 200 V, and 250 V
- Capacitance offerings ranging from 10 pF to 47 μF
- Available capacitance tolerances of $\pm 5\%$, $\pm 10\%$, and $\pm 20\%$
- Non-polar device, minimizing installation concerns
- 100% pure matte tin-plated termination finish allowing for excellent solderability
- SnPb termination finish option available upon request (5% Pb minimum)



Applications

Typical applications include decoupling, bypass, filtering and transient voltage suppression.

Ordering Information

| C | 1206 | C | 106 | M | 4 | R | A | C | TU |
|---------|--|------------------------------------|---|---------------------------------|--|------------|----------------------|---------------------------------|---|
| Ceramic | Case Size (L" x W") | Specification/ Series ¹ | Capacitance Code (pF) | Capacitance Tolerance | Rated Voltage (VDC) | Dielectric | Failure Rate/ Design | Termination Finish ² | Packaging/ Grade (C-Spec) |
| | 0402 0603 0805 1206 1210 1805 1808 1812 1825 2220 2225 | C = Standard | Two significant digits and number of zeros. | J = ±5% K = ±10% M = ±20% | 9 = 6.3 8 = 10 4 = 16 3 = 25 6 = 35 5 = 50 1 = 100 2 = 200 A = 250 | R = X7R | A = N/A | C = 100% Matte Sn | See "Packaging C-Spec Ordering Options Table" |

¹ Flexible termination option is available. Please see FT-CAP product bulletin C1013_X7R_FT-CAP_SMD.

² Additional termination finish options may be available. Contact KEMET for details.

Packaging C-Spec Ordering Options Table

| Packaging Type ¹ | Packaging/Grade Ordering Code (C-Spec) |
|-----------------------------|---|
| Bulk Bag/Unmarked | Not required (Blank) |
| 7" Reel/Unmarked | TU |
| 13" Reel/Unmarked | 7411 (EIA 0603 and smaller case sizes) 7210 (EIA 0805 and larger case sizes) |
| 7" Reel/Marked | TM |
| 13" Reel/Marked | 7040 (EIA 0603) 7215 (EIA 0805 and larger case sizes) |

¹ Default packaging is "Bulk Bag." An ordering code C-Spec is not required for "Bulk Bag" packaging.

¹ The terms "Marked" and "Unmarked" pertain to laser marking option of capacitors. All packaging options labeled as "Unmarked" will contain capacitors that have not been laser marked. Please contact KEMET if you require a laser marked option. For more information see "Capacitor Marking."

Dimensions – Millimeters (Inches)



| EIA Size Code | Metric Size Code | L Length | W Width | T Thickness | B Bandwidth | S Separation Minimum | Mounting Technique |
|-------------------|------------------|-------------------------------|-------------------------------|------------------------------|-------------------------------|----------------------|---------------------------------|
| ¹ 0402 | 1005 | 1.00 (0.040) ±0.05 (0.002) | 0.50 (0.020) ±0.05 (0.002) | See Table 2 for Thickness | 0.30 (0.012) ±0.10 (0.004) | 0.30 (0.012) | Solder reflow only |
| ² 0603 | 1608 | 1.60 (0.063) ±0.15 (0.006) | 0.80 (0.032) ±0.15 (0.006) | | 0.35 (0.014) ±0.15 (0.006) | 0.50 (0.020) | Solder wave or Solder reflow |
| ³ 0805 | 2012 | 2.00 (0.079) ±0.20 (0.008) | 1.25 (0.049) ±0.20 (0.008) | | 0.50 (0.02) ±0.25 (0.010) | 0.70 (0.028) | |
| ⁴ 1206 | 3216 | 3.20 (0.126) ±0.20 (0.008) | 1.60 (0.063) ±0.20 (0.008) | | 0.50 (0.02) ±0.25 (0.010) | 1.50 (0.060) | |
| ⁵ 1210 | 3225 | 3.20 (0.126) ±0.20 (0.008) | 2.50 (0.098) ±0.20 (0.008) | | 0.50 (0.02) ±0.25 (0.010) | 1.50 (0.060) | Solder reflow only |
| 1805 | 4513 | 4.50 (0.177) ±0.50 (0.020) | 1.27 (0.050) ±0.38 (0.015) | | 0.60 (0.024) ±0.35 (0.014) | 2.90 (0.114) | |
| 1808 | 4520 | 4.70 (0.185) ±0.50 (0.020) | 2.00 (0.079) ±0.20 (0.008) | | 0.60 (0.024) ±0.35 (0.014) | 2.90 (0.114) | |
| 1812 | 4532 | 4.50 (0.177) ±0.30 (0.012) | 3.20 (0.126) ±0.30 (0.012) | | 0.60 (0.024) ±0.35 (0.014) | 2.30 (0.091) | |
| 1825 | 4564 | 4.50 (0.177) ±0.30 (0.012) | 6.40 (0.252) ±0.40 (0.016) | | 0.60 (0.024) ±0.35 (0.014) | 2.30 (0.091) | |
| 2220 | 5650 | 5.70 (0.224) ±0.40 (0.016) | 5.00 (0.197) ±0.40 (0.016) | | 0.60 (0.024) ±0.35 (0.014) | 3.50 (0.138) | |
| 2225 | 5664 | 5.60 (0.220) ±0.40 (0.016) | 6.40 (0.248) ±0.40 (0.016) | | 0.60 (0.024) ±0.35 (0.014) | 3.20 (0.126) | |

¹ For capacitance values ≥ 5.6 nF 100V add 0.05 (0.002) to the length and width tolerance dimension

² For capacitance value 0.22 μ F 50V add 0.10 (0.004) to length

³ For capacitance values ≥ 2.2 μ F add 0.10 (0.004) to the length tolerance dimension.

⁴ For capacitance value 10 μ F 16V add 0.10 (0.004) to the length tolerance dimension. For capacitance value 10 nF \leq 250V add 0.10 (0.004) to the length tolerance dimension. For capacitance value 100 nF 250V & 200V add 0.10 (0.004) to the length tolerance dimension.

⁵ For Capacitance value 1.0 μ F \leq 50V add 0.20 (0.008) to Length tolerance dimension and to Width tolerance dimension add 0.10 (0.004), For Capacitance value 1.0 μ F 100V add 0.10 (0.004) to Length tolerance dimension. For capacitance value 2.2 μ F 100V add 0.10 to the Length tolerance dimension, for capacitance values ≥ 4.7 μ F add 0.02 (0.001) to the width tolerance dimension and 0.10 (0.004) to the length tolerance dimension, except for capacitance value 10 μ F 25V and 50V add 0.10 (0.004) to the width tolerance dimension and 0.20 (0.008) to the length tolerance dimension. For capacitance value 220 nF \leq 50V add 0.10 (0.004) to the width tolerance dimension.

Qualification/Certification

Commercial Grade products are subject to internal qualification. Details regarding test methods and conditions are referenced in Table 4, Performance & Reliability.

Environmental Compliance

Lead (Pb)-free, RoHS, and REACH compliant without exemptions.



Table 1A – Capacitance Range/Selection Waterfall (0402 – 1206 Case Sizes)

| Cap | Cap Code | Case Size/ Series | C0402C | | | | | | | C0603C | | | | | | | C0805C | | | | | | | C1206C | | | | | | | | | | |
|----------------|-------------|----------------------|---|----------------------|-------------------------|-------------------------|----|-----|-----|--------|----|----|----|-----|-----|-----|--------|----|----|----|----|----|-----|--------|-----|-----|----|----|----|----|----|-----|-----|-----|
| | | Voltage Code | 9 | 8 | 4 | 3 | 5 | 1 | 9 | 8 | 4 | 3 | 5 | 1 | 2 | A | 9 | 8 | 4 | 3 | 6 | 5 | 1 | 2 | A | 9 | 8 | 4 | 3 | 6 | 5 | 1 | 2 | A |
| | | Rated Voltage (VDC) | 6.3 | 10 | 16 | 25 | 50 | 100 | 6.3 | 10 | 16 | 25 | 50 | 100 | 200 | 250 | 6.3 | 10 | 16 | 25 | 35 | 50 | 100 | 200 | 250 | 6.3 | 10 | 16 | 25 | 35 | 50 | 100 | 200 | 250 |
| | | Cap Tolerance | Product Availability and Chip Thickness Codes – See Table 2 for Chip Thickness Dimensions | | | | | | | | | | | | | | | | | | | | | | | | | | | | | | | |
| 10 - 20 pF* | 100 - 200* | J K M | BB BB BB BB BB | CF CF CF CF CF CF CF | DN DN DN DN DN DN DN DN | EB EB EB EB EB EB EB EB | | | | | | | | | | | | | | | | | | | | | | | | | | | | |
| 22 pF | 220 | J K M | BB BB BB BB BB | CF CF CF CF CF CF CF | DM DM DM DM DM DN DN | EB EB EB EB EB EB EB EB | | | | | | | | | | | | | | | | | | | | | | | | | | | | |
| 24 - 91 pF | 240 - 910* | J K M | BB BB BB BB BB | CF CF CF CF CF CF CF | DN DN DN DN DN DN DN DN | EB EB EB EB EB EB EB EB | | | | | | | | | | | | | | | | | | | | | | | | | | | | |
| 100 - 150 pF** | 101 - 151** | J K M | BB BB BB BB BB | CF CF CF CF CF CF CF | DN DN DN DN DN DN DN DN | EB EB EB EB EB EB EB EB | | | | | | | | | | | | | | | | | | | | | | | | | | | | |
| 180 - 820 pF** | 181 - 821** | J K M | BB BB BB BB BB | CF CF CF CF CF CF CF | DN DN DN DN DN DN DN DN | EB EB EB EB EB EB EB EB | | | | | | | | | | | | | | | | | | | | | | | | | | | | |
| 1000 pF | 102 | J K M | BB BB BB BB BB | CF CF CF CF CF CF CF | DN DN DN DN DN DN DN DN | EB EB EB EB EB EB EB EB | | | | | | | | | | | | | | | | | | | | | | | | | | | | |
| 1200 pF | 122 | J K M | BB BB BB BB BB | CF CF CF CF CF CF CF | DN DN DN DN DN DN DN DN | EB EB EB EB EB EB EB EB | | | | | | | | | | | | | | | | | | | | | | | | | | | | |
| 1500 pF | 152 | J K M | BB BB BB BB BB | CF CF CF CF CF CF CF | DN DN DN DN DN DN DN DN | EB EB EB EB EB EB EB EB | | | | | | | | | | | | | | | | | | | | | | | | | | | | |
| 1800 pF | 182 | J K M | BB BB BB BB BB | CF CF CF CF CF CF CF | DN DN DN DN DN DN DN DN | EB EB EB EB EB EB EB EB | | | | | | | | | | | | | | | | | | | | | | | | | | | | |
| 2200 pF | 222 | J K M | BB BB BB BB BB | CF CF CF CF CF CF CF | DN DN DN DN DN DN DN DN | EB EB EB EB EB EB EB EB | | | | | | | | | | | | | | | | | | | | | | | | | | | | |
| 2700 pF | 272 | J K M | BB BB BB BB BB | CF CF CF CF CF CF CF | DN DN DN DN DN DN DN DN | EB EB EB EB EB EB EB EB | | | | | | | | | | | | | | | | | | | | | | | | | | | | |
| 3300 pF | 332 | J K M | BB BB BB BB BB | CF CF CF CF CF CF CF | DN DN DN DN DN DN DN DN | EB EB EB EB EB EB EB EB | | | | | | | | | | | | | | | | | | | | | | | | | | | | |
| 3900 pF | 392 | J K M | BB BB BB BB BB | CF CF CF CF CF CF CF | DN DN DN DN DN DN DN DN | EB EB EB EB EB EB EB EB | | | | | | | | | | | | | | | | | | | | | | | | | | | | |
| 4700 pF | 472 | J K M | BB BB BB BB BB | CF CF CF CF CF CF CF | DN DN DN DN DN DN DN DN | EB EB EB EB EB EB EB EB | | | | | | | | | | | | | | | | | | | | | | | | | | | | |
| 5600 pF | 562 | J K M | BB BB BB BB BB | CF CF CF CF CF CF CF | DN DN DN DN DN DN DN DN | EB EB EB EB EB EB EB EB | | | | | | | | | | | | | | | | | | | | | | | | | | | | |
| 6800 pF | 682 | J K M | BB BB BB BB BB | CF CF CF CF CF CF CF | DN DN DN DN DN DN DN DN | EB EB EB EB EB EB EB EB | | | | | | | | | | | | | | | | | | | | | | | | | | | | |
| 8200 pF | 822 | J K M | BB BB BB BB BB | CF CF CF CF CF CF CF | DN DN DN DN DN DN DN DN | EB EB EB EB EB EB EB EB | | | | | | | | | | | | | | | | | | | | | | | | | | | | |
| 10000 pF | 103 | J K M | BB BB BB BB BB | CG CG CG CG CG CG CF | DN DN DN DN DN DN DN DN | EL EL EL EL EL EL EL EL | | | | | | | | | | | | | | | | | | | | | | | | | | | | |
| 12000 pF | 123 | J K M | BB BB BB BB BB | CF CF CF CF CF CF CF | DN DN DN DN DN DN DN DN | EB EB EB EB EB EB EB EB | | | | | | | | | | | | | | | | | | | | | | | | | | | | |
| 15000 pF | 153 | J K M | BB BB BB BB BB | CF CF CF CF CF CF CF | DN DN DN DN DN DN DN DN | EQ EQ EQ EQ EQ EQ EQ EQ | | | | | | | | | | | | | | | | | | | | | | | | | | | | |
| 18000 pF | 183 | J K M | BB BB BB BB BB | CF CF CF CF CF CF CF | DN DN DN DN DN DN DN DN | EB EB EB EB EB EB EB EB | | | | | | | | | | | | | | | | | | | | | | | | | | | | |
| 22000 pF | 223 | J K M | BB BB BB BB BB | CF CF CF CF CF CF CF | DN DN DN DN DN DN DN DN | EB EB EB EB EB EB EB EB | | | | | | | | | | | | | | | | | | | | | | | | | | | | |
| 27000 pF | 273 | J K M | BB BB BB BB BB | CF CF CF CF CF CF CF | DN DN DN DN DN DN DP | EB EB EB EB EB EB EB EB | | | | | | | | | | | | | | | | | | | | | | | | | | | | |
| Cap | Cap Code | Rated Voltage (VDC) | 6.3 | 10 | 16 | 25 | 50 | 100 | 6.3 | 10 | 16 | 25 | 50 | 100 | 200 | 250 | 6.3 | 10 | 16 | 25 | 35 | 50 | 100 | 200 | 250 | 6.3 | 10 | 16 | 25 | 35 | 50 | 100 | 200 | 250 |
| Cap | Cap Code | Voltage Code | 9 | 8 | 4 | 3 | 5 | 1 | 9 | 8 | 4 | 3 | 5 | 1 | 2 | A | 9 | 8 | 4 | 3 | 6 | 5 | 1 | 2 | A | 9 | 8 | 4 | 3 | 6 | 5 | 1 | 2 | A |
| Cap | Cap Code | Case Size/ Series | C0402C | | | | | | | C0603C | | | | | | | C0805C | | | | | | | C1206C | | | | | | | | | | |

*Capacitance range Includes E24 decade values only. (i.e., 10, 11, 12, 13, 15, 16, 18, 20, 22, 24, 27, 30, 33, 36, 39, 43, 47, 51, 56, 62, 68, 75, 82, and 91).

**Capacitance range Includes E12 decade values only. (i.e., 10, 12, 15, 18, 22, 27, 33, 39, 47, 56, 68, and 82).

xx' Available only in K and M tolerance.

Table 1A – Capacitance Range/Selection Waterfall (0402 – 1206 Case Sizes) cont.

| Cap | Cap Code | Case Size/ Series | | | C0402C | | | | | | | C0603C | | | | | | | C0805C | | | | | | | C1206C | | | | | | | | | | | | | | | | | | | | | | | | | | | | | | | | | | | | | | | | | | | | | | | | | | | | | | | |
|----------|----------|---------------------|---|---|---|-----------------|-----------------|-----------------|----|-----|-----|--------|----|----|----|-----|-----------------|-----------------|--------|-----------------|----|----|----|----|-----|--------|-----|-----|----|----|----|----|----|-----|-----|-----|----|----|-----------------|-----------------|-----------------|----|----|-----------------|-----------------|----|----|----|----|----|----|----|-----------------|-----------------|----|----|----|----|----|----|----|----|----|----|----|----|----|----|----|----|----|----|----|----|----|----|----|----|----|----|----|
| | | Voltage Code | | | 9 | 8 | 4 | 3 | 5 | 1 | 9 | 8 | 4 | 3 | 5 | 1 | 2 | A | 9 | 8 | 4 | 3 | 6 | 5 | 1 | 2 | A | 9 | 8 | 4 | 3 | 6 | 5 | 1 | 2 | A | | | | | | | | | | | | | | | | | | | | | | | | | | | | | | | | | | | | | | | | | | | | | |
| | | Rated Voltage (VDC) | | | 6.3 | 10 | 16 | 25 | 50 | 100 | 6.3 | 10 | 16 | 25 | 50 | 100 | 200 | 250 | 6.3 | 10 | 16 | 25 | 35 | 50 | 100 | 200 | 250 | 6.3 | 10 | 16 | 25 | 35 | 50 | 100 | 200 | 250 | | | | | | | | | | | | | | | | | | | | | | | | | | | | | | | | | | | | | | | | | | | | | |
| | | Cap Tolerance | | | Product Availability and Chip Thickness Codes – See Table 2 for Chip Thickness Dimensions | | | | | | | | | | | | | | | | | | | | | | | | | | | | | | | | | | | | | | | | | | | | | | | | | | | | | | | | | | | | | | | | | | | | | | | | | | | | |
| 33000 pF | 333 | J | K | M | BB | BB | BB | BB | | | | | | | | | CF | CF | CF | CF | CF | CF | | | | | | | | | | | | DN | DN | DN | DN | DN | DN | DP | DE | DG | EB | EB | EB | EB | EB | EB | EB | EB | EB | EB | EB | | | | | | | | | | | | | | | | | | | | | | | | | | | | |
| 39000 pF | 393 | J | K | M | BB | BB | BB | BB | | | | | | | | | CF | CF | CF | CF | CF | CF | | | | | | | | | | | | | DN | DN | DN | DN | DN | DN | DP | DE | DG | EB | EB | EB | EB | EB | EB | EB | EB | EB | EB | EB | | | | | | | | | | | | | | | | | | | | | | | | | | | |
| 47000 pF | 473 | J | K | M | BB | BB | BB | BB | | | | | | | | | CG | CG | CG | CG | CJ | CF | | | | | | | | | | | | | DO | DO | DO | DO | DO | DO | DE | DG | DG | EB | EB | EB | EB | EB | EB | EB | EB | EB | EB | EB | | | | | | | | | | | | | | | | | | | | | | | | | | | |
| 56000 pF | 563 | J | K | M | BB | BB | BB | | | | | | | | | | CF | CF | CF | CF | CF | CJ | | | | | | | | | | | | | DP | DP | DP | DP | DP | DP | DE | DG | DG | EB | EB | EB | EB | EB | EB | EB | EB | EB | EB | EB | | | | | | | | | | | | | | | | | | | | | | | | | | | |
| 68000 pF | 683 | J | K | M | BB | BB | BB | | | | | | | | | | CF | CF | CF | CF | CF | CJ | | | | | | | | | | | | | DP | DP | DP | DP | DP | DP | DE | DG | DG | EB | EB | EB | EB | EB | EB | EB | EB | EB | EB | EB | | | | | | | | | | | | | | | | | | | | | | | | | | | |
| 82000 pF | 823 | J | K | M | BB | BB | BB | | | | | | | | | | CF | CF | CF | CF | CF | CJ | | | | | | | | | | | | | DP | DP | DP | DP | DP | DP | DE | | | EB | EB | EB | EB | EB | EB | EB | EB | EB | EB | EB | | | | | | | | | | | | | | | | | | | | | | | | | | | |
| 0.1 µF | 104 | J | K | M | BB | BB | BB | BB ¹ | | | | | | | | | CJ | CJ | CJ | CJ | CJ | CJ | | | | | | | | | | | | | DN | DN | DN | DN | DN | DN | DN | DN | DN | EB | EB | EB | EB | EB | EB | EB | EB | EB | EB | EB | | | | | | | | | | | | | | | | | | | | | | | | | | | |
| 0.12 µF | 124 | J | K | M | | | | | | | | | | | | | CF | CF | CF | CF | CF | | | | | | | | | | | | | | DN | DN | DN | DN | DN | DN | DP | DP | DG | EC | EC | EC | EC | EC | EC | EC | EC | EC | EC | EC | | | | | | | | | | | | | | | | | | | | | | | | | | | |
| 0.15 µF | 154 | J | K | M | | | | | | | | | | | | | CF | CF | CF | CF | CF | | | | | | | | | | | | | | DN | DN | DN | DN | DN | DN | DP | DP | DG | EC | EC | EC | EC | EC | EC | EC | EC | EC | EC | EC | | | | | | | | | | | | | | | | | | | | | | | | | | | |
| 0.18 µF | 184 | J | K | M | | | | | | | | | | | | | CF | CF | CF | CF | CF | | | | | | | | | | | | | | DN | DN | DN | DN | DN | DN | DG | DG | DG | EC | EC | EC | EC | EC | EC | EC | EC | EC | EC | EC | | | | | | | | | | | | | | | | | | | | | | | | | | | |
| 0.22 µF | 224 | J | K | M | BB ² | BB ² | BB ² | BB ² | | | | | | | | | CF | CF | CF | CF | CF | CJ | | | | | | | | | | | | | DN | DN | DN | DN | DN | DN | DG | DG | DG | EC | EC | EC | EC | EC | EC | EC | EC | EC | EC | EC | | | | | | | | | | | | | | | | | | | | | | | | | | | |
| 0.27 µF | 274 | J | K | M | | | | | | | | | | | | | CF | CF | CF | | | | | | | | | | | | | | | | DP | DP | DP | DP | DP | DP | DP | DP | DG | EB | EB | EB | EB | EB | EB | EB | EB | EB | EB | EB | | | | | | | | | | | | | | | | | | | | | | | | | | | |
| 0.33 µF | 334 | J | K | M | | | | | | | | | | | | | CF | CF | CF | | | | | | | | | | | | | | | | DG | DG | DG | DG | DG | DG | | | | EB | EB | EB | EB | EB | EB | EB | EB | EB | EB | EB | | | | | | | | | | | | | | | | | | | | | | | | | | | |
| 0.39 µF | 394 | J | K | M | | | | | | | | | | | | | CF | CF | CF | | | | | | | | | | | | | | | | DG | DG | DG | DG | DE | DE | | | | EB | EB | EB | EB | EB | EB | EB | EB | EB | EB | EB | | | | | | | | | | | | | | | | | | | | | | | | | | | |
| 0.47 µF | 474 | J | K | M | BB ¹ | BB ¹ | | | | | | | | | | | CF | CF | CF | CG | | | | | | | | | | | | | | | DG | DG | DG | DG | DG | DG | DG | DG | DG | EC | EC | EC | EC | EC | EC | EC | EC | EC | EC | EC | | | | | | | | | | | | | | | | | | | | | | | | | | | |
| 0.56 µF | 564 | J | K | M | | | | | | | | | | | | | | | | | | | | | | | | | | | | | | | DP | DP | DP | DG | DH | DH | | | | ED | ED | ED | ED | ED | ED | ED | ED | ED | EM | EM | EM | EM | EM | EM | EM | EM | EM | EM | EM | | | | | | | | | | | | | | | | | | |
| 0.68 µF | 684 | J | K | M | | | | | | | | | | | | | | | | | | | | | | | | | | | | | | | DP | DP | DP | DG | | | | | | EF | EF | EF | EF | EF | EF | EF | EF | EF | EM | EM | EM | EM | EM | EM | EM | EM | EM | EM | EM | | | | | | | | | | | | | | | | | | |
| 0.82 µF | 824 | J | K | M | | | | | | | | | | | | | | | | | | | | | | | | | | | | | | | DP | DP | DP | DG | | | | | | EF | EF | EF | EF | EF | EF | EF | EF | EF | EH | EH | EH | EH | EH | EH | EH | EH | EH | EH | EH | | | | | | | | | | | | | | | | | | |
| 1 µF | 105 | J | K | M | | | | | | | | | | | | | CG | CG | CG | CJ ¹ | | | | | | | | | | | | | | | DH | DH | DH | DH | DH ¹ | DH ¹ | DH ¹ | | | | | EP | EP | EP | EP | EP | EP | EP | EP | EP | EH | EH | EH | EH | EH | EH | EH | EH | EH | EH | EH | | | | | | | | | | | | | | | | |
| 1.2 µF | 125 | J | K | M | | | | | | | | | | | | | | | | | | | | | | | | | | | | | | | DE | DE | DE | | | | | | | ED | ED | ED | ED | ED | ED | ED | ED | ED | EH | EH | EH | EH | EH | EH | EH | EH | EH | EH | EH | | | | | | | | | | | | | | | | | | |
| 1.5 µF | 155 | J | K | M | | | | | | | | | | | | | | | | | | | | | | | | | | | | | | | DG | DG | DG | | | | | | | ED | ED | ED | ED | ED | ED | ED | ED | ED | EH | EH | EH | EH | EH | EH | EH | EH | EH | EH | EH | | | | | | | | | | | | | | | | | | |
| 1.8 µF | 185 | J | K | M | | | | | | | | | | | | | | | | | | | | | | | | | | | | | | | DG | DG | DG | | | | | | | ED | ED | ED | ED | ED | ED | ED | ED | ED | EH | EH | EH | EH | EH | EH | EH | EH | EH | EH | EH | | | | | | | | | | | | | | | | | | |
| 2.2 µF | 225 | J | K | M | | | | | | | | | | | | | CG ¹ | CG ¹ | | | | | | | | | | | | | | | | | DH | DH | DH | DH | DH ¹ | DH ¹ | DH ¹ | | | | | EH | EH | EH | EH | EH | EH | EH | EH | EH | EH | EH | EH | EH | EH | EH | EH | EH | EH | EH | EH | | | | | | | | | | | | | | | | |
| 2.7 µF | 275 | J | K | M | | | | | | | | | | | | | | | | | | | | | | | | | | | | | | | | | | | | | | | | EN | EN | EN | EN | EN | EN | EN | EN | EN | EH | EH | EH | EH | EH | EH | EH | EH | EH | EH | EH | | | | | | | | | | | | | | | | | | |
| 3.3 µF | 335 | J | K | M | | | | | | | | | | | | | | | | | | | | | | | | | | | | | | | | | | | | | | | | ED | ED | ED | ED | ED | ED | ED | ED | ED | EH | EH | EH | EH | EH | EH | EH | EH | EH | EH | EH | | | | | | | | | | | | | | | | | | |
| 3.9 µF | 395 | J | K | M | | | | | | | | | | | | | | | | | | | | | | | | | | | | | | | | | | | | | | | | EF | EF | EF | EF | EF | EF | EF | EF | EF | EH | EH | EH | EH | EH | EH | EH | EH | EH | EH | EH | | | | | | | | | | | | | | | | | | |
| 4.7 µF | 475 | J | K | M | | | | | | | | | | | | | | | | | | | | | | | | | | | | | | | | | | | | | | | | EH | EH | EH | EH | EH | EH | EH | EH | EH | EH | EH | EH | EH | EH | EH | EH | EH | EH | EH | EH | | | | | | | | | | | | | | | | | | |
| 5.6 µF | 565 | J | K | M | | | | | | | | | | | | | | | | | | | | | | | | | | | | | | | | | | | | | | | | EH | EH | EH | EH | EH | EH | EH | EH | EH | EH | EH | EH | EH | EH | EH | EH | EH | EH | EH | EH | | | | | | | | | | | | | | | | | | |
| 6.8 µF | 685 | J | K | M | | | | | | | | | | | | | | | | | | | | | | | | | | | | | | | | | | | | | | | | EH | EH | EH | EH | EH | EH | EH | EH | EH | EH | EH | EH | EH | EH | EH | EH | EH | EH | EH | EH | | | | | | | | | | | | | | | | | | |
| 8.2 µF | 825 | J | K | M | | | | | | | | | | | | | | | | | | | | | | | | | | | | | | | | | | | | | | | | EH | EH | EH | EH | EH | EH | EH | EH | EH | EH | EH | EH | EH | EH | EH | EH | EH | EH | EH | EH | | | | | | | | | | | | | | | | | | |
| 10 µF | 106 | J | K | M | | | | | | | | | | | | | | | | | | | | | | | | | | | | | | | | | | | | | | | | DH ¹ | DH ¹ | | | | | | | | EH | EH | EH | EH | EH | EH | EH | EH | EH | EH | EH | EH | EH | EH | EH | EH | EH | EH | EH | EH | | | | | | | | | |
| 22 µF | 226 | J | K | M | | | | | | | | | | | | | | | | | | | | | | | | | | | | | | | | | | | | | | | | DH ¹ | DH ¹ | | | | | | | | EH ¹ | EH ¹ | | | | | | | | EH | EH | EH | EH | EH | EH | EH | EH | EH | EH | EH | EH | EH | EH | EH | EH | EH | EH | EH | EH |
| Cap | Cap Code | Rated Voltage (VDC) | | | 6.3 | 10 | 16 | 25 | 50 | 100 | 6.3 | 10 | 16 | 25 | 50 | 100 | 200 | 250 | 6.3 | 10 | 16 | 25 | 35 | 50 | 100 | 200 | 250 | 6.3 | 10 | 16 | 25 | 35 | 50 | 100 | 200 | 250 | | | | | | | | | | | | | | | | | | | | | | | | | | | | | | | | | | | | | | | | | | | | | |
| | | Voltage Code | | | 9 | 8 | 4 | 3 | 5 | 1 | 9 | 8 | 4 | 3 | 5 | 1 | 2 | A | 9 | 8 | 4 | 3 | 6 | 5 | 1 | 2 | A | 9 | 8 | 4 | 3 | 6 | 5 | 1 | 2 | A | | | | | | | | | | | | | | | | | | | | | | | | | | | | | | | | | | | | | | | | | | | | | |
| | | Case Size/ Series | | | C0402C | | | | | | | C0603C | | | | | | | C0805C | | | | | | | C1206C | | | | | | | | | | | | | | | | | | | | | | | | | | | | | | | | | | | | | | | | | | | | | | | | | | | | | | | |

*Capacitance range Includes E24 decade values only. (i.e., 10, 11, 12, 13, 15, 16, 18, 20, 22, 24, 27, 30, 33, 36, 39, 43, 47, 51, 56, 62, 68, 75, 82, and 91).

**Capacitance range Includes E12 decade values only. (i.e., 10, 12, 15, 18, 22, 27, 33, 39, 47, 56, 68, and 82).

xx¹ Available only in K and M tolerance.

xx² Available only in M tolerance.

Table 1B – Capacitance Range/Selection Waterfall (1210 – 1812 Case Sizes) cont.

| Cap | Cap Code | Case Size/ Series | | | C1210C | | | | | | | | | C1805C | | | C1808C | | | C1812C ² | | | | |
|----------|----------|----------------------|---|---|---|-----------------|-----------------|-----------------|-----------------|-----------------|-----|-----|----|--------|-----|----|--------|-----|----|---------------------|-----|-----------------|-----|----|
| | | Voltage Code | | | 9 | 8 | 4 | 3 | 5 | 1 | 2 | A | 5 | 1 | 2 | 5 | 1 | 2 | 3 | 5 | 1 | 2 | A | |
| | | Rated Voltage (VDC) | | | 6.3 | 10 | 16 | 25 | 50 | 100 | 200 | 250 | 50 | 100 | 200 | 50 | 100 | 200 | 25 | 50 | 100 | 200 | 250 | |
| | | Cap Tolerance | | | Product Availability and Chip Thickness Codes – See Table 2 for Chip Thickness Dimensions | | | | | | | | | | | | | | | | | | | |
| 82000 pF | 823 | J | K | M | FB | FB | FB | FB | FB | FC | FF | FF | NA | | | | LD | | | GB | GB | GB | GB | GB |
| 0.1 µF | 104 | J | K | M | FB | FB | FB | FB | FB | FD | FG | FG | NA | | | | LD | | | GB | GB | GB | GB | GB |
| 0.12 µF | 124 | J | K | M | FB | FB | FB | FB | FB | FD | FH | FH | | | | | LD | | | GB | GB | GB | GB | GB |
| 0.15 µF | 154 | J | K | M | FC | FC | FC | FC | FC | FD | FM | FM | | | | | LD | | | GB | GB | GB | GE | GE |
| 0.18 µF | 184 | J | K | M | FC | FC | FC | FC | FC | FD | FK | FK | | | | | LD | | | GB | GB | GB | GG | GG |
| 0.22 µF | 224 | J | K | M | FF | FF | FF | FF | FF | FD | FK | FK | | | | | | | | GB | GB | GB | GG | GG |
| 0.27 µF | 274 | J | K | M | FC | FC | FC | FC | FC | FD | FP | FP | | | | | | | | GB | GB | GG | GG | GG |
| 0.33 µF | 334 | J | K | M | FD | FD | FD | FD | FD | FD | FM | FM | | | | | | | | GB | GB | GG | GG | GG |
| 0.39 µF | 394 | J | K | M | FD | FD | FD | FD | FD | FD | FK | FK | | | | | | | | GB | GB | GG | GG | GG |
| 0.47 µF | 474 | J | K | M | FD | FD | FD | FD | FD | FD | FS | FS | | | | | | | | GB | GB | GG | GJ | GJ |
| 0.56 µF | 564 | J | K | M | FD | FD | FD | FD | FD | FF | | | | | | | | | | GC | GC | GG | | |
| 0.68 µF | 684 | J | K | M | FD | FD | FD | FD | FD | FG | | | | | | | | | | GC | GC | GG | | |
| 0.82 µF | 824 | J | K | M | FF | FF | FF | FF | FF | FL | | | | | | | | | | GE | GE | GG | | |
| 1 µF | 105 | J | K | M | FZ | FZ | FZ | FZ | FZ | FT | | | | | | | | | | GE | GE | GG | | |
| 1.2 µF | 125 | J | K | M | FH | FH | FH | FH | FG | FH | | | | | | | | | | GB | GB | GB | | |
| 1.5 µF | 155 | J | K | M | FH | FH | FH | FH | FG | FM | | | | | | | | | | GC | GC | GC | | |
| 1.8 µF | 185 | J | K | M | FH | FH | FH | FH | FG | FJ | | | | | | | | | | GE | GE | GE | | |
| 2.2 µF | 225 | J | K | M | FJ | FJ | FJ | FJ | FY | FY ¹ | | | | | | | | | | GO | GO | GO ¹ | | |
| 2.7 µF | 275 | J | K | M | FE | FE | FE | FG | FH | | | | | | | | | | | GJ | GJ | GJ | | |
| 3.3 µF | 335 | J | K | M | FF | FF | FF | FM | FM | | | | | | | | | | | GL | GL | GL | | |
| 3.9 µF | 395 | J | K | M | FG | FG | FG | FG | FK | | | | | | | | | | | GK | GK | | | |
| 4.7 µF | 475 | J | K | M | FC | FC | FC | FG | FS | | | | | | | | | | | GK | GK | | | |
| 5.6 µF | 565 | J | K | M | FF | FF | FF | FH | | | | | | | | | | | | | | | | |
| 6.8 µF | 685 | J | K | M | FG | FG | FG | FM | | | | | | | | | | | | | | | | |
| 8.2 µF | 825 | J | K | M | FH | FH | FH | FK | | | | | | | | | | | | | | | | |
| 10 µF | 106 | J | K | M | FT ¹ | FT ¹ | FT ¹ | GA ¹ | FS ¹ | | | | | | | | | | | GK | | | | |
| 15 µF | 156 | J | K | M | FM | FM | | | | | | | | | | | | | | | | | | |
| 22 µF | 226 | | | | FS | FS | FS ¹ | FS ¹ | | | | | | | | | | | | | | | | |
| 47 µF | 476 | | | | FS ¹ | FS ¹ | | | | | | | | | | | | | | | | | | |
| Cap | Cap Code | Rated Voltage (VDC) | | | 6.3 | 10 | 16 | 25 | 50 | 100 | 200 | 250 | 50 | 100 | 200 | 50 | 100 | 200 | 25 | 50 | 100 | 200 | 250 | |
| | | Voltage Code | | | 9 | 8 | 4 | 3 | 5 | 1 | 2 | A | 5 | 1 | 2 | 5 | 1 | 2 | 3 | 5 | 1 | 2 | A | |
| | | Case Size/Series | | | C1210C | | | | | | | | | C1805C | | | C1808C | | | C1812C ² | | | | |

*Capacitance range Includes E24 decade values only. (i.e., 10, 11, 12, 13, 15, 16, 18, 20, 22, 24, 27, 30, 33, 36, 39, 43, 47, 51, 56, 62, 68, 75, 82, and 91).

**Capacitance range Includes E12 decade values only. (i.e., 10, 12, 15, 18, 22, 27, 33, 39, 47, 56, 68, and 82).

xx¹ Available only in K and M tolerance.

² Available capacitance values available in [X7R with KONNEKT Technology](#).

Table 2A – Chip Thickness/Tape & Reel Packaging Quantities

| Thickness Code | Case Size | Thickness ± Range (mm) | Paper Quantity | | Plastic Quantity | |
|----------------|------------------------|------------------------|-----------------------------|----------|------------------|----------|
| | | | 7" Reel | 13" Reel | 7" Reel | 13" Reel |
| BB | 0402 | 0.50 ± 0.05 | 10,000 | 50,000 | 0 | 0 |
| CF | 0603 | 0.80 ± 0.07 | 4,000 | 15,000 | 0 | 0 |
| CG | 0603 | 0.80 ± 0.10 | 4,000 | 15,000 | 0 | 0 |
| CJ | 0603 | 0.80 ± 0.15 | 4,000 | 15,000 | 0 | 0 |
| DM | 0805 | 0.70 ± 0.20 | 4,000 | 15,000 | 0 | 0 |
| DN | 0805 | 0.78 ± 0.10 | 4,000 | 15,000 | 0 | 0 |
| DO | 0805 | 0.80 ± 0.10 | 4,000 | 15,000 | 0 | 0 |
| DP | 0805 | 0.90 ± 0.10 | 4,000 | 15,000 | 0 | 0 |
| DE | 0805 | 1.00 ± 0.10 | 0 | 0 | 2,500 | 10,000 |
| DG | 0805 | 1.25 ± 0.15 | 0 | 0 | 2,500 | 10,000 |
| DH | 0805 | 1.25 ± 0.20 | 0 | 0 | 2,500 | 10,000 |
| EB | 1206 | 0.78 ± 0.10 | 0 | 0 | 4,000 | 10,000 |
| EQ | 1206 | 0.78 ± 0.20 | 0 | 0 | 4,000 | 10,000 |
| EC | 1206 | 0.90 ± 0.10 | 0 | 0 | 4,000 | 10,000 |
| EN | 1206 | 0.95 ± 0.10 | 0 | 0 | 4,000 | 10,000 |
| ED | 1206 | 1.00 ± 0.10 | 0 | 0 | 2,500 | 10,000 |
| EE | 1206 | 1.10 ± 0.10 | 0 | 0 | 2,500 | 10,000 |
| EF | 1206 | 1.20 ± 0.15 | 0 | 0 | 2,500 | 10,000 |
| EP | 1206 | 1.20 ± 0.20 | 0 | 0 | 2,500 | 10,000 |
| EM | 1206 | 1.25 ± 0.15 | 0 | 0 | 2,500 | 10,000 |
| EL | 1206 | 1.25 ± 0.20 | 0 | 0 | 2,500 | 10,000 |
| EG | 1206 | 1.60 ± 0.15 | 0 | 0 | 2,000 | 8,000 |
| EH | 1206 | 1.60 ± 0.20 | 0 | 0 | 2,000 | 8,000 |
| FB | 1210 | 0.78 ± 0.10 | 0 | 0 | 4,000 | 10,000 |
| FC | 1210 | 0.90 ± 0.10 | 0 | 0 | 4,000 | 10,000 |
| FD | 1210 | 0.95 ± 0.10 | 0 | 0 | 4,000 | 10,000 |
| FE | 1210 | 1.00 ± 0.10 | 0 | 0 | 2,500 | 10,000 |
| FF | 1210 | 1.10 ± 0.10 | 0 | 0 | 2,500 | 10,000 |
| FG | 1210 | 1.25 ± 0.15 | 0 | 0 | 2,500 | 10,000 |
| FZ | 1210 | 1.25 ± 0.20 | 0 | 0 | 2,500 | 10,000 |
| FL | 1210 | 1.40 ± 0.15 | 0 | 0 | 2,000 | 8,000 |
| FH | 1210 | 1.55 ± 0.15 | 0 | 0 | 2,000 | 8,000 |
| FP | 1210 | 1.60 ± 0.20 | 0 | 0 | 2,000 | 8,000 |
| FM | 1210 | 1.70 ± 0.20 | 0 | 0 | 2,000 | 8,000 |
| FJ | 1210 | 1.85 ± 0.20 | 0 | 0 | 2,000 | 8,000 |
| FT | 1210 | 1.90 ± 0.20 | 0 | 0 | 2,000 | 8,000 |
| GA | 1210 | 1.90 ± 0.20* | 0 | 0 | 1,000 | 4,000 |
| FY | 1210 | 2.00 ± 0.20 | 0 | 0 | 2,000 | 8,000 |
| FK | 1210 | 2.10 ± 0.20 | 0 | 0 | 2,000 | 8,000 |
| FS | 1210 | 2.50 ± 0.30 | 0 | 0 | 1,000 | 4,000 |
| NA | 1805 | 0.90 ± 0.10 | 0 | 0 | 4,000 | 10,000 |
| NC | 1805 | 1.00 ± 0.15 | 0 | 0 | 4,000 | 10,000 |
| LD | 1808 | 0.90 ± 0.10 | 0 | 0 | 2,500 | 10,000 |
| LF | 1808 | 1.00 ± 0.15 | 0 | 0 | 2,500 | 10,000 |
| Thickness Code | Case Size ¹ | Thickness ± Range (mm) | 7" Reel | 13" Reel | 7" Reel | 13" Reel |
| | | | Paper Quantity ¹ | | Plastic Quantity | |

Package quantity based on finished chip thickness specifications.

Table 2A – Chip Thickness/Tape & Reel Packaging Quantities cont.

| Thickness Code | Case Size | Thickness ± Range (mm) | Paper Quantity | | Plastic Quantity | |
|----------------|------------------------|------------------------|-----------------------------|----------|------------------|----------|
| | | | 7" Reel | 13" Reel | 7" Reel | 13" Reel |
| GB | 1812 | 1.00 ± 0.10 | 0 | 0 | 1,000 | 4,000 |
| GC | 1812 | 1.10 ± 0.10 | 0 | 0 | 1,000 | 4,000 |
| GD | 1812 | 1.25 ± 0.15 | 0 | 0 | 1,000 | 4,000 |
| GE | 1812 | 1.30 ± 0.10 | 0 | 0 | 1,000 | 4,000 |
| GH | 1812 | 1.40 ± 0.15 | 0 | 0 | 1,000 | 4,000 |
| GG | 1812 | 1.55 ± 0.10 | 0 | 0 | 1,000 | 4,000 |
| GK | 1812 | 1.60 ± 0.20 | 0 | 0 | 1,000 | 4,000 |
| GJ | 1812 | 1.70 ± 0.15 | 0 | 0 | 1,000 | 4,000 |
| GL | 1812 | 1.90 ± 0.20 | 0 | 0 | 500 | 2,000 |
| GO | 1812 | 2.50 ± 0.20 | 0 | 0 | 500 | 2,000 |
| HB | 1825 | 1.10 ± 0.15 | 0 | 0 | 1,000 | 4,000 |
| HC | 1825 | 1.15 ± 0.15 | 0 | 0 | 1,000 | 4,000 |
| HD | 1825 | 1.30 ± 0.15 | 0 | 0 | 1,000 | 4,000 |
| HE | 1825 | 1.40 ± 0.15 | 0 | 0 | 1,000 | 4,000 |
| HF | 1825 | 1.50 ± 0.15 | 0 | 0 | 1,000 | 4,000 |
| JB | 2220 | 1.00 ± 0.15 | 0 | 0 | 1,000 | 4,000 |
| JC | 2220 | 1.10 ± 0.15 | 0 | 0 | 1,000 | 4,000 |
| JD | 2220 | 1.30 ± 0.15 | 0 | 0 | 1,000 | 4,000 |
| JE | 2220 | 1.40 ± 0.15 | 0 | 0 | 1,000 | 4,000 |
| JF | 2220 | 1.50 ± 0.15 | 0 | 0 | 1,000 | 4,000 |
| JO | 2220 | 2.40 ± 0.15 | 0 | 0 | 500 | 2,000 |
| KB | 2225 | 1.00 ± 0.15 | 0 | 0 | 1,000 | 4,000 |
| KC | 2225 | 1.10 ± 0.15 | 0 | 0 | 1,000 | 4,000 |
| KD | 2225 | 1.30 ± 0.15 | 0 | 0 | 1,000 | 4,000 |
| KE | 2225 | 1.40 ± 0.15 | 0 | 0 | 1,000 | 4,000 |
| Thickness Code | Case Size ¹ | Thickness ± Range (mm) | 7" Reel | 13" Reel | 7" Reel | 13" Reel |
| | | | Paper Quantity ¹ | | Plastic Quantity | |

Package quantity based on finished chip thickness specifications.

Table 2B – Bulk Packaging Quantities

| Packaging Type | | Loose Packaging | |
|-------------------------------|-------------|--|---------|
| | | Bulk Bag (default) | |
| Packaging C-Spec ¹ | | N/A ² | |
| Case Size | | Packaging Quantities (pieces/unit packaging) | |
| EIA (in) | Metric (mm) | Minimum | Maximum |
| 0402 | 1005 | 1 | 50,000 |
| 0603 | 1608 | | |
| 0805 | 2012 | | |
| 1206 | 3216 | | |
| 1210 | 3225 | | |
| 1808 | 4520 | | 20,000 |
| 1812 | 4532 | | |
| 1825 | 4564 | | |
| 2220 | 5650 | | |
| 2225 | 5664 | | |

¹ The "Packaging C-Spec" is a 4 to 8 digit code which identifies the packaging type and/or product grade. When ordering, the proper code must be included in the 15th through 22nd character positions of the ordering code. See "Ordering Information" section of this document for further details. Commercial grade product ordered without a packaging C-Spec will default to our standard "Bulk Bag" packaging. Contact KEMET if you require a bulk bag packaging option for automotive grade products.

² A packaging C-Spec (see note 1 above) is not required for "Bulk Bag" packaging (excluding anti-static Bulk Bag and automotive grade products). The 15th through 22nd character positions of the ordering code should be left blank. All product ordered without a packaging C-Spec will default to our standard "Bulk Bag" packaging.

Table 3 – Chip Capacitor Land Pattern Design Recommendations per IPC–7351

| EIA Size Code | Metric Size Code | Density Level A: Maximum (Most) Land Protrusion (mm) | | | | | Density Level B: Median (Nominal) Land Protrusion (mm) | | | | | Density Level C: Minimum (Least) Land Protrusion (mm) | | | | |
|-------------------|------------------|--|------|------|------|------|--|------|------|------|------|---|------|------|------|------|
| | | C | Y | X | V1 | V2 | C | Y | X | V1 | V2 | C | Y | X | V1 | V2 |
| 0402 | 1005 | 0.50 | 0.72 | 0.72 | 2.20 | 1.20 | 0.45 | 0.62 | 0.62 | 1.90 | 1.00 | 0.40 | 0.52 | 0.52 | 1.60 | 0.80 |
| 0603 | 1608 | 0.90 | 1.15 | 1.10 | 4.00 | 2.10 | 0.80 | 0.95 | 1.00 | 3.10 | 1.50 | 0.60 | 0.75 | 0.90 | 2.40 | 1.20 |
| 0805 | 2012 | 1.00 | 1.35 | 1.55 | 4.40 | 2.60 | 0.90 | 1.15 | 1.45 | 3.50 | 2.00 | 0.75 | 0.95 | 1.35 | 2.80 | 1.70 |
| 1206 | 3216 | 1.60 | 1.35 | 1.90 | 5.60 | 2.90 | 1.50 | 1.15 | 1.80 | 4.70 | 2.30 | 1.40 | 0.95 | 1.70 | 4.00 | 2.00 |
| 1210 | 3225 | 1.60 | 1.35 | 2.80 | 5.65 | 3.80 | 1.50 | 1.15 | 2.70 | 4.70 | 3.20 | 1.40 | 0.95 | 2.60 | 4.00 | 2.90 |
| 1210 ¹ | 3225 | 1.50 | 1.60 | 2.90 | 5.60 | 3.90 | 1.40 | 1.40 | 2.80 | 4.70 | 3.30 | 1.30 | 1.20 | 2.70 | 4.00 | 3.00 |
| 1808 | 4520 | 2.30 | 1.75 | 2.30 | 7.40 | 3.30 | 2.20 | 1.55 | 2.20 | 6.50 | 2.70 | 2.10 | 1.35 | 2.10 | 5.80 | 2.40 |
| 1812 | 4532 | 2.15 | 1.60 | 3.60 | 6.90 | 4.60 | 2.05 | 1.40 | 3.50 | 6.00 | 4.00 | 1.95 | 1.20 | 3.40 | 5.30 | 3.70 |
| 1825 | 4564 | 2.15 | 1.60 | 6.90 | 6.90 | 7.90 | 2.05 | 1.40 | 6.80 | 6.00 | 7.30 | 1.95 | 1.20 | 6.70 | 5.30 | 7.00 |
| 2220 | 5650 | 2.75 | 1.70 | 5.50 | 8.20 | 6.50 | 2.65 | 1.50 | 5.40 | 7.30 | 5.90 | 2.55 | 1.30 | 5.30 | 6.60 | 5.60 |
| 2225 | 5664 | 2.70 | 1.70 | 6.90 | 8.10 | 7.90 | 2.60 | 1.50 | 6.80 | 7.20 | 7.30 | 2.50 | 1.30 | 6.70 | 6.50 | 7.00 |

¹ Only for capacitance values $\geq 22 \mu\text{F}$

Density Level A: For low-density product applications. Recommended for wave solder applications and provides a wider process window for reflow solder processes. KEMET only recommends wave soldering of EIA 0603, 0805, and 1206 case sizes.

Density Level B: For products with a moderate level of component density. Provides a robust solder attachment condition for reflow solder processes.

Density Level C: For high component density product applications. Before adapting the minimum land pattern variations the user should perform qualification testing based on the conditions outlined in IPC Standard 7351 (IPC–7351).

Image below based on Density Level B for an EIA 1210 case size.

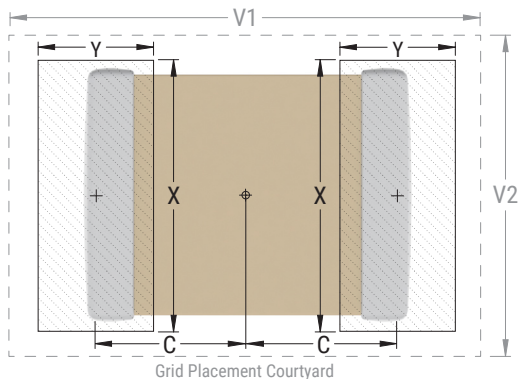

Soldering Process

Recommended Soldering Technique:

- Solder wave or solder reflow for EIA case sizes 0603, 0805 and 1206
- All other EIA case sizes are limited to solder reflow only

Recommended Reflow Soldering Profile:

KEMET’s families of surface mount multilayer ceramic capacitors (SMD MLCCs) are compatible with wave (single or dual), convection, IR or vapor phase reflow techniques. Preheating of these components is recommended to avoid extreme thermal stress. KEMET’s recommended profile conditions for convection and IR reflow reflect the profile conditions of the IPC/J-STD-020 standard for moisture sensitivity testing. These devices can safely withstand a maximum of three reflow passes at these conditions.

| Profile Feature | Termination Finish | |
|---|--------------------|--------------------|
| | SnPb | 100% Matte Sn |
| Preheat/Soak | | |
| Temperature Minimum (T_{Smin}) | 100°C | 150°C |
| Temperature Maximum (T_{Smax}) | 150°C | 200°C |
| Time (t_s) from T_{Smin} to T_{Smax} | 60 – 120 seconds | 60 – 120 seconds |
| Ramp-Up Rate (T_L to T_p) | 3°C/second maximum | 3°C/second maximum |
| Liquidous Temperature (T_L) | 183°C | 217°C |
| Time Above Liquidous (t_L) | 60 – 150 seconds | 60 – 150 seconds |
| Peak Temperature (T_p) | 235°C | 260°C |
| Time Within 5°C of Maximum Peak Temperature (t_p) | 20 seconds maximum | 30 seconds maximum |
| Ramp-Down Rate (T_p to T_L) | 6°C/second maximum | 6°C/second maximum |
| Time 25°C to Peak Temperature | 6 minutes maximum | 8 minutes maximum |

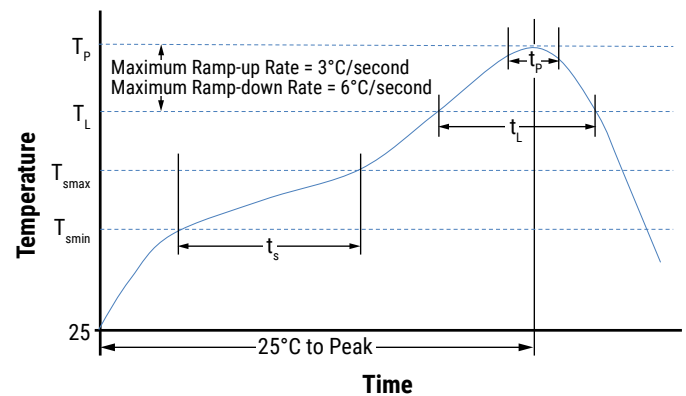

Note 1: All temperatures refer to the center of the package, measured on the capacitor body surface that is facing up during assembly reflow.

X7R Performance and Reliability: SMD Test Methods and Conditions

| Test | Reference | Test Condition | Limits | | | | | | | | | | | | | | | | | | | | | | | | | | | | | | | | | | | | | | | | | | | | | | | | | | | | | | | | | | | | | | | | | | | | | | | | | | | | | | | | | | | | |
|-------------------------|------------------------|---|--|---------------|------------------|-------------|--------------------------------|------|------|---------------------|-----|------------------------|------|----|---------------------|-----|------------------------|------|----|---------------------|-----|------------------------|------|------|-----|-----|-------------------|------|---------------------|-----|---------|-----|------|-----|------|------------------------|------|---------|-------------------|------|---------------------|-----|---------|-----|------|---------------------|-----|------|------------------------|------|---------|------|------------------------|------|-------------------|------|--------------------|-----|---------|-----|------|-----|-----|------|-----------------------|------|---------|-------------------|------|--------------------|-----|---------|-----|------|-----|------|-----------------------|------|---------|-------------|------|-----|-----|---------|-----|------|-----|
| Visual and Mechanical | KEMET Internal | No defects that may affect performance (10X) | Dimensions according KEMET Spec Sheet | | | | | | | | | | | | | | | | | | | | | | | | | | | | | | | | | | | | | | | | | | | | | | | | | | | | | | | | | | | | | | | | | | | | | | | | | | | | | | | | | | | | |
| Capacitance (Cap) | KEMET Internal | $C \leq 10 \mu\text{F}$ 1 kHz ± 50 Hz and $1.0 \pm 0.2 V_{\text{rms}}$ or $0.5 \pm 0.2 V_{\text{rms}}$ * $C > 10 \mu\text{F}$ 120 Hz ± 10 Hz and $0.5 \pm 0.1 V_{\text{rms}}$ * See part number specification sheet for voltage Capacitance measurements (including tolerance) are indexed to a referee time of 48 or 1,000 hours Please refer to a part number specification sheet for referee time details | Within Tolerance | | | | | | | | | | | | | | | | | | | | | | | | | | | | | | | | | | | | | | | | | | | | | | | | | | | | | | | | | | | | | | | | | | | | | | | | | | | | | | | | | | | | |
| Dissipation Factor (DF) | KEMET Internal | $C \leq 10 \mu\text{F}$ Frequency: 1 kHz ± 50 Hz Voltage*: $1.0 \pm 0.2 V_{\text{rms}}$, $0.5 \pm 0.2 V_{\text{rms}}$ $C > 10 \mu\text{F}$ Frequency: 120 Hz ± 10 Hz Voltage: $0.5 \pm 0.1 V_{\text{rms}}$ * See part number specification sheet for voltage | <p style="text-align: center;">Within Specification</p> <table border="1"> <thead> <tr> <th>EIA Case Size</th> <th>Rated DC Voltage</th> <th>Capacitance</th> <th>Dissipation Factor (Maximum %)</th> </tr> </thead> <tbody> <tr> <td rowspan="4">0402</td> <td rowspan="2">< 16</td> <td>< 0.1 μF</td> <td>5.0</td> </tr> <tr> <td>$\geq 0.1 \mu\text{F}$</td> <td>10.0</td> </tr> <tr> <td rowspan="2">16</td> <td>< 0.1 μF</td> <td>3.5</td> </tr> <tr> <td>$\geq 0.1 \mu\text{F}$</td> <td>10.0</td> </tr> <tr> <td rowspan="2">25</td> <td>< 0.1 μF</td> <td>3.5</td> </tr> <tr> <td>$\geq 0.1 \mu\text{F}$</td> <td>10.0</td> </tr> <tr> <td>> 25</td> <td>All</td> <td>2.5</td> </tr> <tr> <td rowspan="4">0603¹</td> <td>< 16</td> <td rowspan="2">< 1.0 μF</td> <td>5.0</td> </tr> <tr> <td>16 / 25</td> <td>3.5</td> </tr> <tr> <td>> 25</td> <td>2.5</td> </tr> <tr> <td>< 16</td> <td rowspan="2">$\geq 1.0 \mu\text{F}$</td> <td>10.0</td> </tr> <tr> <td>16 / 25</td> </tr> <tr> <td rowspan="5">0805²</td> <td>< 16</td> <td rowspan="2">< 2.2 μF</td> <td>5.0</td> </tr> <tr> <td>16 / 25</td> <td>3.5</td> </tr> <tr> <td>> 25</td> <td>< 1.0 μF</td> <td>2.5</td> </tr> <tr> <td>< 16</td> <td rowspan="2">$\geq 2.2 \mu\text{F}$</td> <td>10.0</td> </tr> <tr> <td>16 / 25</td> </tr> <tr> <td>> 25</td> <td>$\geq 1.0 \mu\text{F}$</td> <td>10.0</td> </tr> <tr> <td rowspan="5">1206³</td> <td>< 16</td> <td rowspan="2">< 10 μF</td> <td>5.0</td> </tr> <tr> <td>16 / 25</td> <td>3.5</td> </tr> <tr> <td>> 25</td> <td>All</td> <td>2.5</td> </tr> <tr> <td>< 16</td> <td rowspan="2">$\geq 10 \mu\text{F}$</td> <td>10.0</td> </tr> <tr> <td>16 / 25</td> </tr> <tr> <td rowspan="5">1210⁴</td> <td>< 16</td> <td rowspan="2">< 22 μF</td> <td>5.0</td> </tr> <tr> <td>16 / 25</td> <td>3.5</td> </tr> <tr> <td>> 25</td> <td>2.5</td> </tr> <tr> <td>< 16</td> <td rowspan="2">$\geq 22 \mu\text{F}$</td> <td>10.0</td> </tr> <tr> <td>16 / 25</td> </tr> <tr> <td rowspan="3">1805 – 2225</td> <td>< 16</td> <td rowspan="3">All</td> <td>5.0</td> </tr> <tr> <td>16 / 25</td> <td>3.5</td> </tr> <tr> <td>> 25</td> <td>2.5</td> </tr> </tbody> </table> | EIA Case Size | Rated DC Voltage | Capacitance | Dissipation Factor (Maximum %) | 0402 | < 16 | < 0.1 μF | 5.0 | $\geq 0.1 \mu\text{F}$ | 10.0 | 16 | < 0.1 μF | 3.5 | $\geq 0.1 \mu\text{F}$ | 10.0 | 25 | < 0.1 μF | 3.5 | $\geq 0.1 \mu\text{F}$ | 10.0 | > 25 | All | 2.5 | 0603 ¹ | < 16 | < 1.0 μF | 5.0 | 16 / 25 | 3.5 | > 25 | 2.5 | < 16 | $\geq 1.0 \mu\text{F}$ | 10.0 | 16 / 25 | 0805 ² | < 16 | < 2.2 μF | 5.0 | 16 / 25 | 3.5 | > 25 | < 1.0 μF | 2.5 | < 16 | $\geq 2.2 \mu\text{F}$ | 10.0 | 16 / 25 | > 25 | $\geq 1.0 \mu\text{F}$ | 10.0 | 1206 ³ | < 16 | < 10 μF | 5.0 | 16 / 25 | 3.5 | > 25 | All | 2.5 | < 16 | $\geq 10 \mu\text{F}$ | 10.0 | 16 / 25 | 1210 ⁴ | < 16 | < 22 μF | 5.0 | 16 / 25 | 3.5 | > 25 | 2.5 | < 16 | $\geq 22 \mu\text{F}$ | 10.0 | 16 / 25 | 1805 – 2225 | < 16 | All | 5.0 | 16 / 25 | 3.5 | > 25 | 2.5 |
| EIA Case Size | Rated DC Voltage | Capacitance | Dissipation Factor (Maximum %) | | | | | | | | | | | | | | | | | | | | | | | | | | | | | | | | | | | | | | | | | | | | | | | | | | | | | | | | | | | | | | | | | | | | | | | | | | | | | | | | | | | | |
| 0402 | < 16 | < 0.1 μF | 5.0 | | | | | | | | | | | | | | | | | | | | | | | | | | | | | | | | | | | | | | | | | | | | | | | | | | | | | | | | | | | | | | | | | | | | | | | | | | | | | | | | | | | | |
| | | $\geq 0.1 \mu\text{F}$ | 10.0 | | | | | | | | | | | | | | | | | | | | | | | | | | | | | | | | | | | | | | | | | | | | | | | | | | | | | | | | | | | | | | | | | | | | | | | | | | | | | | | | | | | | |
| | 16 | < 0.1 μF | 3.5 | | | | | | | | | | | | | | | | | | | | | | | | | | | | | | | | | | | | | | | | | | | | | | | | | | | | | | | | | | | | | | | | | | | | | | | | | | | | | | | | | | | | |
| | | $\geq 0.1 \mu\text{F}$ | 10.0 | | | | | | | | | | | | | | | | | | | | | | | | | | | | | | | | | | | | | | | | | | | | | | | | | | | | | | | | | | | | | | | | | | | | | | | | | | | | | | | | | | | | |
| 25 | < 0.1 μF | 3.5 | | | | | | | | | | | | | | | | | | | | | | | | | | | | | | | | | | | | | | | | | | | | | | | | | | | | | | | | | | | | | | | | | | | | | | | | | | | | | | | | | | | | | |
| | $\geq 0.1 \mu\text{F}$ | 10.0 | | | | | | | | | | | | | | | | | | | | | | | | | | | | | | | | | | | | | | | | | | | | | | | | | | | | | | | | | | | | | | | | | | | | | | | | | | | | | | | | | | | | | |
| > 25 | All | 2.5 | | | | | | | | | | | | | | | | | | | | | | | | | | | | | | | | | | | | | | | | | | | | | | | | | | | | | | | | | | | | | | | | | | | | | | | | | | | | | | | | | | | | | |
| 0603 ¹ | < 16 | < 1.0 μF | 5.0 | | | | | | | | | | | | | | | | | | | | | | | | | | | | | | | | | | | | | | | | | | | | | | | | | | | | | | | | | | | | | | | | | | | | | | | | | | | | | | | | | | | | |
| | 16 / 25 | | 3.5 | | | | | | | | | | | | | | | | | | | | | | | | | | | | | | | | | | | | | | | | | | | | | | | | | | | | | | | | | | | | | | | | | | | | | | | | | | | | | | | | | | | | |
| | > 25 | 2.5 | | | | | | | | | | | | | | | | | | | | | | | | | | | | | | | | | | | | | | | | | | | | | | | | | | | | | | | | | | | | | | | | | | | | | | | | | | | | | | | | | | | | | |
| | < 16 | $\geq 1.0 \mu\text{F}$ | 10.0 | | | | | | | | | | | | | | | | | | | | | | | | | | | | | | | | | | | | | | | | | | | | | | | | | | | | | | | | | | | | | | | | | | | | | | | | | | | | | | | | | | | | |
| 16 / 25 | | | | | | | | | | | | | | | | | | | | | | | | | | | | | | | | | | | | | | | | | | | | | | | | | | | | | | | | | | | | | | | | | | | | | | | | | | | | | | | | | | | | | | | |
| 0805 ² | < 16 | < 2.2 μF | 5.0 | | | | | | | | | | | | | | | | | | | | | | | | | | | | | | | | | | | | | | | | | | | | | | | | | | | | | | | | | | | | | | | | | | | | | | | | | | | | | | | | | | | | |
| | 16 / 25 | | 3.5 | | | | | | | | | | | | | | | | | | | | | | | | | | | | | | | | | | | | | | | | | | | | | | | | | | | | | | | | | | | | | | | | | | | | | | | | | | | | | | | | | | | | |
| | > 25 | < 1.0 μF | 2.5 | | | | | | | | | | | | | | | | | | | | | | | | | | | | | | | | | | | | | | | | | | | | | | | | | | | | | | | | | | | | | | | | | | | | | | | | | | | | | | | | | | | | |
| | < 16 | $\geq 2.2 \mu\text{F}$ | 10.0 | | | | | | | | | | | | | | | | | | | | | | | | | | | | | | | | | | | | | | | | | | | | | | | | | | | | | | | | | | | | | | | | | | | | | | | | | | | | | | | | | | | | |
| | 16 / 25 | | | | | | | | | | | | | | | | | | | | | | | | | | | | | | | | | | | | | | | | | | | | | | | | | | | | | | | | | | | | | | | | | | | | | | | | | | | | | | | | | | | | | | |
| > 25 | $\geq 1.0 \mu\text{F}$ | 10.0 | | | | | | | | | | | | | | | | | | | | | | | | | | | | | | | | | | | | | | | | | | | | | | | | | | | | | | | | | | | | | | | | | | | | | | | | | | | | | | | | | | | | | |
| 1206 ³ | < 16 | < 10 μF | 5.0 | | | | | | | | | | | | | | | | | | | | | | | | | | | | | | | | | | | | | | | | | | | | | | | | | | | | | | | | | | | | | | | | | | | | | | | | | | | | | | | | | | | | |
| | 16 / 25 | | 3.5 | | | | | | | | | | | | | | | | | | | | | | | | | | | | | | | | | | | | | | | | | | | | | | | | | | | | | | | | | | | | | | | | | | | | | | | | | | | | | | | | | | | | |
| | > 25 | All | 2.5 | | | | | | | | | | | | | | | | | | | | | | | | | | | | | | | | | | | | | | | | | | | | | | | | | | | | | | | | | | | | | | | | | | | | | | | | | | | | | | | | | | | | |
| | < 16 | $\geq 10 \mu\text{F}$ | 10.0 | | | | | | | | | | | | | | | | | | | | | | | | | | | | | | | | | | | | | | | | | | | | | | | | | | | | | | | | | | | | | | | | | | | | | | | | | | | | | | | | | | | | |
| | 16 / 25 | | | | | | | | | | | | | | | | | | | | | | | | | | | | | | | | | | | | | | | | | | | | | | | | | | | | | | | | | | | | | | | | | | | | | | | | | | | | | | | | | | | | | | |
| 1210 ⁴ | < 16 | < 22 μF | 5.0 | | | | | | | | | | | | | | | | | | | | | | | | | | | | | | | | | | | | | | | | | | | | | | | | | | | | | | | | | | | | | | | | | | | | | | | | | | | | | | | | | | | | |
| | 16 / 25 | | 3.5 | | | | | | | | | | | | | | | | | | | | | | | | | | | | | | | | | | | | | | | | | | | | | | | | | | | | | | | | | | | | | | | | | | | | | | | | | | | | | | | | | | | | |
| | > 25 | 2.5 | | | | | | | | | | | | | | | | | | | | | | | | | | | | | | | | | | | | | | | | | | | | | | | | | | | | | | | | | | | | | | | | | | | | | | | | | | | | | | | | | | | | | |
| | < 16 | $\geq 22 \mu\text{F}$ | 10.0 | | | | | | | | | | | | | | | | | | | | | | | | | | | | | | | | | | | | | | | | | | | | | | | | | | | | | | | | | | | | | | | | | | | | | | | | | | | | | | | | | | | | |
| | 16 / 25 | | | | | | | | | | | | | | | | | | | | | | | | | | | | | | | | | | | | | | | | | | | | | | | | | | | | | | | | | | | | | | | | | | | | | | | | | | | | | | | | | | | | | | |
| 1805 – 2225 | < 16 | All | 5.0 | | | | | | | | | | | | | | | | | | | | | | | | | | | | | | | | | | | | | | | | | | | | | | | | | | | | | | | | | | | | | | | | | | | | | | | | | | | | | | | | | | | | |
| | 16 / 25 | | 3.5 | | | | | | | | | | | | | | | | | | | | | | | | | | | | | | | | | | | | | | | | | | | | | | | | | | | | | | | | | | | | | | | | | | | | | | | | | | | | | | | | | | | | |
| | > 25 | | 2.5 | | | | | | | | | | | | | | | | | | | | | | | | | | | | | | | | | | | | | | | | | | | | | | | | | | | | | | | | | | | | | | | | | | | | | | | | | | | | | | | | | | | | |

¹ For Cap value 0.22 μF (16 V and 25 V) DF is 5% and for Cap value 4.7 μF (25 V) DF is 3.5%.
² For Cap value 1.0 μF (16 V and 25 V) DF is 5%.
³ For Cap value 2.2 μF (25 V) and $\geq 2.2 \mu\text{F}$ (35 and 50 V) DF is 10%. For Cap Value 1.0uF (100V) DF is 5.0%. For Cap value 1.0 μF (50V & 35V) DF is 3.5%.
⁴ For Cap value 10uF (16V, 25V and 50V) DF is 5%. For Cap value 4.7 μF (50 V) DF is 5%. For Cap value 2.2uF (100V) DF is 10%. For Cap value 1.0 μF ($\leq 50\text{V}$) DF is 5.0%.

X7R Performance and Reliability: SMD Test Methods and Conditions cont.

| Test | Reference | Test Condition | Limits | | | | | | | | | | | | | | | | | | | | | | | | | | | | | | | | | | | | | | | | | | | | | | | | | | | | | | | | | | | | | | | | | | | | | | | | | | | | | | | | | |
|----------------------------|----------------|---|---|---|------------------------------------|---------------------------------|---------------------------------|--|---------------|------------------|------------------------------------|---------------------------------|---------------------------------|------|-----|------------|----------------------|-----------|-------------------|---------|------------|----------------------|-----------|-------|-----|-----|-----|-------------------|---------|-----------|--------------------|----------|-------|-----------|-----|-----------|-------------------|---------|-----------|--------------------|----------|-------|-----------|-----|-----------|-------------------|---------|-----------|-------------------|---------|-------|-----------|-----|-----------|------|-----|-----|-----|-----|------|-----|-----|-----|-----|------|-----|----------|----------|-----|------|-----|-----|-----|-----|------|-----|---------|---------|-----|------|-----|-----|-----|-----|
| Insulation Resistance (IR) | KEMET Internal | Apply rated voltage for 120 seconds at 25°C | <p>Within Specification</p> <p>To obtain IR limit, divide MQ - μF value by the capacitance and compare to GΩ limit. Select the lower of the two limits.</p> <table border="1"> <thead> <tr> <th colspan="5">Insulation Resistance (IR) Limits Table</th> </tr> <tr> <th>EIA Case Size</th> <th>Rated DC Voltage</th> <th>1,000 megohm microfarads or 100 GΩ</th> <th>500 megohm microfarads or 10 GΩ</th> <th>100 megohm microfarads or 10 GΩ</th> </tr> </thead> <tbody> <tr> <td>0402</td> <td>ALL</td> <td>< 0.012 μF</td> <td>≥ 0.012 μF < 0.47 μf</td> <td>≥ 0.47 μf</td> </tr> <tr> <td rowspan="2">0603¹</td> <td>≤ 200 V</td> <td>< 0.047 μF</td> <td>≥ 0.047 μf < 0.47 μf</td> <td>≥ 0.47 μf</td> </tr> <tr> <td>250 V</td> <td>N/A</td> <td>N/A</td> <td>ALL</td> </tr> <tr> <td rowspan="2">0805²</td> <td>≤ 200 V</td> <td>< 0.15 μF</td> <td>≥ 0.15 μF < 2.2 μf</td> <td>≥ 2.2 μf</td> </tr> <tr> <td>250 V</td> <td>< .027 μF</td> <td>N/A</td> <td>≥ .027 μF</td> </tr> <tr> <td rowspan="2">1206³</td> <td>≤ 200 V</td> <td>< 0.47 μF</td> <td>≥ 0.47 μF < 2.2 μf</td> <td>≥ 2.2 μf</td> </tr> <tr> <td>250 V</td> <td>< 0.12 μF</td> <td>N/A</td> <td>≥ 0.12 μF</td> </tr> <tr> <td rowspan="2">1210⁴</td> <td>≤ 200 V</td> <td>< 0.39 μF</td> <td>≥ 0.39 μF < 10 μf</td> <td>≥ 10 μf</td> </tr> <tr> <td>250 V</td> <td>< 0.27 μF</td> <td>N/A</td> <td>≥ 0.27 μF</td> </tr> <tr> <td>1805</td> <td>ALL</td> <td>ALL</td> <td>N/A</td> <td>N/A</td> </tr> <tr> <td>1808</td> <td>ALL</td> <td>ALL</td> <td>N/A</td> <td>N/A</td> </tr> <tr> <td>1812</td> <td>ALL</td> <td>< 2.2 μF</td> <td>≥ 2.2 μF</td> <td>N/A</td> </tr> <tr> <td>1825</td> <td>ALL</td> <td>ALL</td> <td>N/A</td> <td>N/A</td> </tr> <tr> <td>2220</td> <td>ALL</td> <td>< 10 μF</td> <td>≥ 10 μF</td> <td>N/A</td> </tr> <tr> <td>2225</td> <td>ALL</td> <td>ALL</td> <td>N/A</td> <td>N/A</td> </tr> </tbody> </table> <p>¹ For Cap value 10 nF (≤ 100 V) IR should be calculated under 500 megohm microfarads or 10 GΩ. For Cap values 5.6nF, 6.8nF, 8.2nF & 10nF (100V) IR should be calculated under 500 megohm microfarads or 10 GΩ.</p> <p>² For Cap value 1.0μF (50 V) IR should be calculated under 100 megohm microfarads or 10 GΩ. For Cap value 0.1uF (≤ 50V) IR should be calculated under 500 mohms or 10GOhms</p> <p>³ For Cap value 4.7μF (50 V) IR should be calculated under 100 megohm microfarads or 10 GΩ. For Capacitance value 10nF (≤ 250V) IR should be calculated under 500 megohm microfarads or 10 GΩ. For Capacitance value 100nF (250V & 200V) IR should be calculated under 500 megohm microfarads or 10 GΩ.</p> <p>⁴ For Capa value 4.7μF (50 V) IR should be calculated under 100 megohm microfarads or 10 GΩ. For Capacitance value 220nF (≤50V) IR should be calculated under 500 megohm microfarads or 10 GΩ.</p> | Insulation Resistance (IR) Limits Table | | | | | EIA Case Size | Rated DC Voltage | 1,000 megohm microfarads or 100 GΩ | 500 megohm microfarads or 10 GΩ | 100 megohm microfarads or 10 GΩ | 0402 | ALL | < 0.012 μF | ≥ 0.012 μF < 0.47 μf | ≥ 0.47 μf | 0603 ¹ | ≤ 200 V | < 0.047 μF | ≥ 0.047 μf < 0.47 μf | ≥ 0.47 μf | 250 V | N/A | N/A | ALL | 0805 ² | ≤ 200 V | < 0.15 μF | ≥ 0.15 μF < 2.2 μf | ≥ 2.2 μf | 250 V | < .027 μF | N/A | ≥ .027 μF | 1206 ³ | ≤ 200 V | < 0.47 μF | ≥ 0.47 μF < 2.2 μf | ≥ 2.2 μf | 250 V | < 0.12 μF | N/A | ≥ 0.12 μF | 1210 ⁴ | ≤ 200 V | < 0.39 μF | ≥ 0.39 μF < 10 μf | ≥ 10 μf | 250 V | < 0.27 μF | N/A | ≥ 0.27 μF | 1805 | ALL | ALL | N/A | N/A | 1808 | ALL | ALL | N/A | N/A | 1812 | ALL | < 2.2 μF | ≥ 2.2 μF | N/A | 1825 | ALL | ALL | N/A | N/A | 2220 | ALL | < 10 μF | ≥ 10 μF | N/A | 2225 | ALL | ALL | N/A | N/A |
| | | | Insulation Resistance (IR) Limits Table | | | | | | | | | | | | | | | | | | | | | | | | | | | | | | | | | | | | | | | | | | | | | | | | | | | | | | | | | | | | | | | | | | | | | | | | | | | | | | | | | |
| | | | EIA Case Size | Rated DC Voltage | 1,000 megohm microfarads or 100 GΩ | 500 megohm microfarads or 10 GΩ | 100 megohm microfarads or 10 GΩ | | | | | | | | | | | | | | | | | | | | | | | | | | | | | | | | | | | | | | | | | | | | | | | | | | | | | | | | | | | | | | | | | | | | | | | | | | | | | |
| | | | 0402 | ALL | < 0.012 μF | ≥ 0.012 μF < 0.47 μf | ≥ 0.47 μf | | | | | | | | | | | | | | | | | | | | | | | | | | | | | | | | | | | | | | | | | | | | | | | | | | | | | | | | | | | | | | | | | | | | | | | | | | | | | |
| | | | 0603 ¹ | ≤ 200 V | < 0.047 μF | ≥ 0.047 μf < 0.47 μf | ≥ 0.47 μf | | | | | | | | | | | | | | | | | | | | | | | | | | | | | | | | | | | | | | | | | | | | | | | | | | | | | | | | | | | | | | | | | | | | | | | | | | | | | |
| | | | | 250 V | N/A | N/A | ALL | | | | | | | | | | | | | | | | | | | | | | | | | | | | | | | | | | | | | | | | | | | | | | | | | | | | | | | | | | | | | | | | | | | | | | | | | | | | | |
| | | | 0805 ² | ≤ 200 V | < 0.15 μF | ≥ 0.15 μF < 2.2 μf | ≥ 2.2 μf | | | | | | | | | | | | | | | | | | | | | | | | | | | | | | | | | | | | | | | | | | | | | | | | | | | | | | | | | | | | | | | | | | | | | | | | | | | | | |
| | | | | 250 V | < .027 μF | N/A | ≥ .027 μF | | | | | | | | | | | | | | | | | | | | | | | | | | | | | | | | | | | | | | | | | | | | | | | | | | | | | | | | | | | | | | | | | | | | | | | | | | | | | |
| | | | 1206 ³ | ≤ 200 V | < 0.47 μF | ≥ 0.47 μF < 2.2 μf | ≥ 2.2 μf | | | | | | | | | | | | | | | | | | | | | | | | | | | | | | | | | | | | | | | | | | | | | | | | | | | | | | | | | | | | | | | | | | | | | | | | | | | | | |
| | | | | 250 V | < 0.12 μF | N/A | ≥ 0.12 μF | | | | | | | | | | | | | | | | | | | | | | | | | | | | | | | | | | | | | | | | | | | | | | | | | | | | | | | | | | | | | | | | | | | | | | | | | | | | | |
| | | | 1210 ⁴ | ≤ 200 V | < 0.39 μF | ≥ 0.39 μF < 10 μf | ≥ 10 μf | | | | | | | | | | | | | | | | | | | | | | | | | | | | | | | | | | | | | | | | | | | | | | | | | | | | | | | | | | | | | | | | | | | | | | | | | | | | | |
| | | | | 250 V | < 0.27 μF | N/A | ≥ 0.27 μF | | | | | | | | | | | | | | | | | | | | | | | | | | | | | | | | | | | | | | | | | | | | | | | | | | | | | | | | | | | | | | | | | | | | | | | | | | | | | |
| | | | 1805 | ALL | ALL | N/A | N/A | | | | | | | | | | | | | | | | | | | | | | | | | | | | | | | | | | | | | | | | | | | | | | | | | | | | | | | | | | | | | | | | | | | | | | | | | | | | | |
| | | | 1808 | ALL | ALL | N/A | N/A | | | | | | | | | | | | | | | | | | | | | | | | | | | | | | | | | | | | | | | | | | | | | | | | | | | | | | | | | | | | | | | | | | | | | | | | | | | | | |
| | | | 1812 | ALL | < 2.2 μF | ≥ 2.2 μF | N/A | | | | | | | | | | | | | | | | | | | | | | | | | | | | | | | | | | | | | | | | | | | | | | | | | | | | | | | | | | | | | | | | | | | | | | | | | | | | | |
| 1825 | ALL | ALL | N/A | N/A | | | | | | | | | | | | | | | | | | | | | | | | | | | | | | | | | | | | | | | | | | | | | | | | | | | | | | | | | | | | | | | | | | | | | | | | | | | | | | | | |
| 2220 | ALL | < 10 μF | ≥ 10 μF | N/A | | | | | | | | | | | | | | | | | | | | | | | | | | | | | | | | | | | | | | | | | | | | | | | | | | | | | | | | | | | | | | | | | | | | | | | | | | | | | | | | |
| 2225 | ALL | ALL | N/A | N/A | | | | | | | | | | | | | | | | | | | | | | | | | | | | | | | | | | | | | | | | | | | | | | | | | | | | | | | | | | | | | | | | | | | | | | | | | | | | | | | | |

X7R Performance and Reliability: SMD Test Methods and Conditions cont.

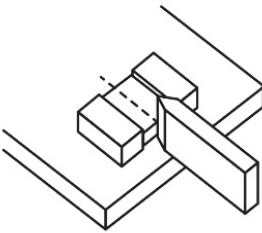
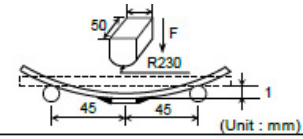
| Test | Reference | Test Condition | Limits | | | | | | | | | | | | |
|---|-------------------|--|--|------------------|------|-------|------|-------|------|-------------------|------|--------|--|-----|----------------------------------|
| Temperature Coefficient of Capacitance (TCC) | KEMET Internal | $C \leq 10\mu\text{F}$ Frequency: 1 kHz \pm 50 Hz Voltage*: 1.0 \pm 0.2 V _{rms} , 0.5 \pm 0.2 V _{rms} , 0.2 \pm 0.1 V _{rms} $C > 10\mu\text{F}$ Frequency: 120 Hz \pm 10 Hz Voltage: 0.5 \pm 0.1 V _{rms} * See part number specification sheet for voltage <table border="1" style="margin-left: auto; margin-right: auto;"> <thead> <tr> <th>Step</th> <th>Temperature (°C)</th> </tr> </thead> <tbody> <tr> <td>1</td> <td>+25°C</td> </tr> <tr> <td>2</td> <td>-55°C</td> </tr> <tr> <td>3</td> <td>+25°C (Reference)</td> </tr> <tr> <td>4</td> <td>+125°C</td> </tr> </tbody> </table> | Step | Temperature (°C) | 1 | +25°C | 2 | -55°C | 3 | +25°C (Reference) | 4 | +125°C | Capacitance \pm 15% over -55°C to +125°C | | |
| Step | Temperature (°C) | | | | | | | | | | | | | | |
| 1 | +25°C | | | | | | | | | | | | | | |
| 2 | -55°C | | | | | | | | | | | | | | |
| 3 | +25°C (Reference) | | | | | | | | | | | | | | |
| 4 | +125°C | | | | | | | | | | | | | | |
| Dielectric Withstanding Voltage (DWV) | KEMET Internal | 250% of rated voltage (5 \pm 1 seconds and charge/discharge not exceeding 50 mA) | Cap: Initial Limit DF: Initial Limit IR: Initial Limit Withstand test voltage without insulation breakdown or damage. | | | | | | | | | | | | |
| Aging Rate (Maximum % Capacitance Loss/Decade Hour) | KEMET Internal | Capacitance measurements (including tolerance) are indexed to a referee time of 48 or 1,000 hours. Please refer to a part number specific datasheet for referee time details. | Please refer to a part number specification sheet for specific Aging rate | | | | | | | | | | | | |
| Terminal Strength | KEMET Internal | Shear stress test per specific case size, Time: 60 \pm 1 seconds <table border="1" style="margin-left: auto; margin-right: auto;"> <thead> <tr> <th>Case Size</th> <th>Force</th> </tr> </thead> <tbody> <tr> <td>0201</td> <td>2N</td> </tr> <tr> <td>0402</td> <td>3N</td> </tr> <tr> <td>0603</td> <td>5N</td> </tr> <tr> <td>0805</td> <td>9N</td> </tr> <tr> <td>\geq1206</td> <td>18N</td> </tr> </tbody> </table>  | Case Size | Force | 0201 | 2N | 0402 | 3N | 0603 | 5N | 0805 | 9N | \geq 1206 | 18N | No evidence of mechanical damage |
| Case Size | Force | | | | | | | | | | | | | | |
| 0201 | 2N | | | | | | | | | | | | | | |
| 0402 | 3N | | | | | | | | | | | | | | |
| 0603 | 5N | | | | | | | | | | | | | | |
| 0805 | 9N | | | | | | | | | | | | | | |
| \geq 1206 | 18N | | | | | | | | | | | | | | |
| Board Flex | AEC-Q200-005 | Standard Termination system 2.0 mm Flexible Termination System 3.0 mm Test time: 60 \pm 5 seconds Ramp time: 1 mm/second  | No evidence of mechanical damage | | | | | | | | | | | | |

X7R Performance and Reliability: SMD Test Methods and Conditions cont.

| Test | Reference | Test Condition | Limits | | | | | | | | | | | | |
|-----------------------|------------------------|--|---|-----------------------|--|---------|------|-----|-----|-----|-----|-----|-----|------|------|
| Solderability | J-STD-002 | Condition: 4 hours ± 15 minutes at 155°C dry bake apply all methods Test 245 ±5°C (SnPb and Pb-Free) | Visual Inspection. 95% coverage on termination. No leaching | | | | | | | | | | | | |
| Temperature Cycling | JESD22 Method JA-104 | 1,000 cycles (-55°C to +125°C) 2 – 3 cycles per hour Soak Time 1 or 5 minutes | Measurement at 24 hours ±4 hours after test conclusion. Cap: Initial Limit DF: Initial Limit IR: Initial Limit | | | | | | | | | | | | |
| Biased Humidity | MIL-STD-202 Method 103 | Load Humidity: 1,000 hours 85°C/85% RH and rated voltage. Low Volt Humidity: 1,000 hours 85°C/85% RH and 1.5 V. | Measurement at 24 hours ±4 hours after test conclusion. Within Post Environmental Limits Cap: ±20% shift IR: 10% of Initial Limit <table border="1"> <thead> <tr> <th colspan="2">DF Limits Maximum (%)</th> </tr> <tr> <th>Initial</th> <th>Post</th> </tr> </thead> <tbody> <tr> <td>2.5</td> <td>3.0</td> </tr> <tr> <td>3.5</td> <td>5.0</td> </tr> <tr> <td>5.0</td> <td>7.5</td> </tr> <tr> <td>10.0</td> <td>20.0</td> </tr> </tbody> </table> | DF Limits Maximum (%) | | Initial | Post | 2.5 | 3.0 | 3.5 | 5.0 | 5.0 | 7.5 | 10.0 | 20.0 |
| DF Limits Maximum (%) | | | | | | | | | | | | | | | |
| Initial | Post | | | | | | | | | | | | | | |
| 2.5 | 3.0 | | | | | | | | | | | | | | |
| 3.5 | 5.0 | | | | | | | | | | | | | | |
| 5.0 | 7.5 | | | | | | | | | | | | | | |
| 10.0 | 20.0 | | | | | | | | | | | | | | |
| Moisture Resistance | MIL-STD-202 Method 106 | Number of cycles required 10, 24 hours per cycle. Steps 7a and 7b not required. | Measurement at 24 hours ±4 hours after test conclusion. Within Post Environmental Limits Cap: ±20% shift IR: 10% of Initial Limit <table border="1"> <thead> <tr> <th colspan="2">DF Limits Maximum (%)</th> </tr> <tr> <th>Initial</th> <th>Post</th> </tr> </thead> <tbody> <tr> <td>2.5</td> <td>3.0</td> </tr> <tr> <td>3.5</td> <td>5.0</td> </tr> <tr> <td>5.0</td> <td>7.5</td> </tr> <tr> <td>10.0</td> <td>20.0</td> </tr> </tbody> </table> | DF Limits Maximum (%) | | Initial | Post | 2.5 | 3.0 | 3.5 | 5.0 | 5.0 | 7.5 | 10.0 | 20.0 |
| DF Limits Maximum (%) | | | | | | | | | | | | | | | |
| Initial | Post | | | | | | | | | | | | | | |
| 2.5 | 3.0 | | | | | | | | | | | | | | |
| 3.5 | 5.0 | | | | | | | | | | | | | | |
| 5.0 | 7.5 | | | | | | | | | | | | | | |
| 10.0 | 20.0 | | | | | | | | | | | | | | |
| Thermal Shock | MIL-STD-202 Method 107 | Number of cycles required 5, (-55°C to 125°C) Dwell time 15 minutes. | Cap: Initial Limit DF: Initial Limit IR: Initial Limit | | | | | | | | | | | | |

X7R Performance and Reliability: SMD Test Methods and Conditions cont.

| Test | Reference | Test Condition | Limits | | | | | | | | | | | | |
|------------------------|---------------------------------|---|--|-----------------------|--|---------|------|-----|-----|-----|-----|-----|-----|------|------|
| High Temperature Life | MIL-STD-202 Method 108 | 1,000 hours at 125°C with 2 X rated voltage applied excluding the following: | Within Post Environmental Limits Cap: ±20% shift IR: 10% of Initial Limit <table border="1"> <thead> <tr> <th colspan="2">DF Limits Maximum (%)</th> </tr> <tr> <th>Initial</th> <th>Post</th> </tr> </thead> <tbody> <tr> <td>2.5</td> <td>3.0</td> </tr> <tr> <td>3.5</td> <td>5.0</td> </tr> <tr> <td>5.0</td> <td>7.5</td> </tr> <tr> <td>10.0</td> <td>20.0</td> </tr> </tbody> </table> | DF Limits Maximum (%) | | Initial | Post | 2.5 | 3.0 | 3.5 | 5.0 | 5.0 | 7.5 | 10.0 | 20.0 |
| DF Limits Maximum (%) | | | | | | | | | | | | | | | |
| Initial | Post | | | | | | | | | | | | | | |
| 2.5 | 3.0 | | | | | | | | | | | | | | |
| 3.5 | 5.0 | | | | | | | | | | | | | | |
| 5.0 | 7.5 | | | | | | | | | | | | | | |
| 10.0 | 20.0 | | | | | | | | | | | | | | |
| Storage Life | 1,000 hours at 125°C, Unpowered | | | | | | | | | | | | | | |
| Vibration | MIL-STD-202 Method 204 | 5 g's for 20 minutes, 12 cycles each of 3 orientations. Test from 10 – 2,000 Hz | Cap: Initial Limit DF: Initial Limit IR: Initial Limit | | | | | | | | | | | | |
| Mechanical Shock | MIL-STD-202 Method 213 | 1,500 g's 0.5 ms Half-sine, Velocity Change 15.4 feet/second (Condition F) | Cap: Initial Limit DF: Initial Limit IR: Initial Limit | | | | | | | | | | | | |
| Resistance to Solvents | MIL-STD-202 Method 215 | Add Aqueous wash chemical OKEMCLEAN (A 6% concentrated Oakite cleaner) or equivalent. Do not use banned solvents. | Visual Inspection 10X Readable marking, no decoloration or stains. No physical damage. | | | | | | | | | | | | |

Storage & Handling

Ceramic chip capacitors should be stored in normal working environments. While the chips themselves are quite robust in other environments, solderability will be degraded by exposure to high temperatures, high humidity, corrosive atmospheres, and long term storage. In addition, packaging materials will be degraded by high temperature – reels may soften or warp and tape peel force may increase. KEMET recommends that maximum storage temperature not exceed 40°C and maximum storage humidity not exceed 70% relative humidity. Temperature fluctuations should be minimized to avoid condensation on the parts and atmospheres should be free of chlorine and sulfur bearing compounds. For optimized solderability chip stock should be used promptly, preferably within 1.5 years of receipt.

Construction (Typical)



Capacitor Marking (Optional)

These surface mount multilayer ceramic capacitors are normally supplied unmarked. If required, they can be marked as an extra cost option. Marking is available on most KEMET devices, but must be requested using the correct ordering code identifier(s). If this option is requested, two sides of the ceramic body will be laser marked with a “K” to identify KEMET, followed by two characters (per EIA-198 - see table below) to identify the capacitance value. EIA 0603 case size devices are limited to the “K” character only.

Laser marking option is not available on:

- COG, ultra stable X8R and Y5V dielectric devices.
- EIA 0402 case size devices.
- EIA 0603 case size devices with flexible termination option.
- KPS commercial and automotive grade stacked devices.
- X7R dielectric products in capacitance values outlined below.

Marking appears in legible contrast. Illustrated below is an example of an MLCC with laser marking of “KA8”, which designates a KEMET device with rated capacitance of 100 μ F. Orientation of marking is vendor optional.



| EIA Case Size | Metric Size Code | Capacitance |
|---------------|------------------|----------------------|
| 0603 | 1608 | ≤ 170 pF |
| 0805 | 2012 | ≤ 150 pF |
| 1206 | 3216 | ≤ 910 pF |
| 1210 | 3225 | $\leq 2,000$ pF |
| 1808 | 4520 | $\leq 3,900$ pF |
| 1812 | 4532 | $\leq 6,700$ pF |
| 1825 | 4564 | ≤ 0.018 μ F |
| 2220 | 5650 | ≤ 0.027 μ F |
| 2225 | 5664 | ≤ 0.033 μ F |

Capacitor Marking (Optional) cont.

| Capacitance (pF) For Various Alpha/Numeral Identifiers | | | | | | | | | | |
|--|---------|-----|----|-----|-------|--------|---------|-----------|------------|-------------|
| Alpha Character | Numeral | | | | | | | | | |
| | 9 | 0 | 1 | 2 | 3 | 4 | 5 | 6 | 7 | 8 |
| Capacitance (pF) | | | | | | | | | | |
| A | 0.10 | 1.0 | 10 | 100 | 1,000 | 10,000 | 100,000 | 1,000,000 | 10,000,000 | 100,000,000 |
| B | 0.11 | 1.1 | 11 | 110 | 1,100 | 11,000 | 110,000 | 1,100,000 | 11,000,000 | 110,000,000 |
| C | 0.12 | 1.2 | 12 | 120 | 1,200 | 12,000 | 120,000 | 1,200,000 | 12,000,000 | 120,000,000 |
| D | 0.13 | 1.3 | 13 | 130 | 1,300 | 13,000 | 130,000 | 1,300,000 | 13,000,000 | 130,000,000 |
| E | 0.15 | 1.5 | 15 | 150 | 1,500 | 15,000 | 150,000 | 1,500,000 | 15,000,000 | 150,000,000 |
| F | 0.16 | 1.6 | 16 | 160 | 1,600 | 16,000 | 160,000 | 1,600,000 | 16,000,000 | 160,000,000 |
| G | 0.18 | 1.8 | 18 | 180 | 1,800 | 18,000 | 180,000 | 1,800,000 | 18,000,000 | 180,000,000 |
| H | 0.20 | 2.0 | 20 | 200 | 2,000 | 20,000 | 200,000 | 2,000,000 | 20,000,000 | 200,000,000 |
| J | 0.22 | 2.2 | 22 | 220 | 2,200 | 22,000 | 220,000 | 2,200,000 | 22,000,000 | 220,000,000 |
| K | 0.24 | 2.4 | 24 | 240 | 2,400 | 24,000 | 240,000 | 2,400,000 | 24,000,000 | 240,000,000 |
| L | 0.27 | 2.7 | 27 | 270 | 2,700 | 27,000 | 270,000 | 2,700,000 | 27,000,000 | 270,000,000 |
| M | 0.30 | 3.0 | 30 | 300 | 3,000 | 30,000 | 300,000 | 3,000,000 | 30,000,000 | 300,000,000 |
| N | 0.33 | 3.3 | 33 | 330 | 3,300 | 33,000 | 330,000 | 3,300,000 | 33,000,000 | 330,000,000 |
| P | 0.36 | 3.6 | 36 | 360 | 3,600 | 36,000 | 360,000 | 3,600,000 | 36,000,000 | 360,000,000 |
| Q | 0.39 | 3.9 | 39 | 390 | 3,900 | 39,000 | 390,000 | 3,900,000 | 39,000,000 | 390,000,000 |
| R | 0.43 | 4.3 | 43 | 430 | 4,300 | 43,000 | 430,000 | 4,300,000 | 43,000,000 | 430,000,000 |
| S | 0.47 | 4.7 | 47 | 470 | 4,700 | 47,000 | 470,000 | 4,700,000 | 47,000,000 | 470,000,000 |
| T | 0.51 | 5.1 | 51 | 510 | 5,100 | 51,000 | 510,000 | 5,100,000 | 51,000,000 | 510,000,000 |
| U | 0.56 | 5.6 | 56 | 560 | 5,600 | 56,000 | 560,000 | 5,600,000 | 56,000,000 | 560,000,000 |
| V | 0.62 | 6.2 | 62 | 620 | 6,200 | 62,000 | 620,000 | 6,200,000 | 62,000,000 | 620,000,000 |
| W | 0.68 | 6.8 | 68 | 680 | 6,800 | 68,000 | 680,000 | 6,800,000 | 68,000,000 | 680,000,000 |
| X | 0.75 | 7.5 | 75 | 750 | 7,500 | 75,000 | 750,000 | 7,500,000 | 75,000,000 | 750,000,000 |
| Y | 0.82 | 8.2 | 82 | 820 | 8,200 | 82,000 | 820,000 | 8,200,000 | 82,000,000 | 820,000,000 |
| Z | 0.91 | 9.1 | 91 | 910 | 9,100 | 91,000 | 910,000 | 9,100,000 | 91,000,000 | 910,000,000 |
| a | 0.25 | 2.5 | 25 | 250 | 2,500 | 25,000 | 250,000 | 2,500,000 | 25,000,000 | 250,000,000 |
| b | 0.35 | 3.5 | 35 | 350 | 3,500 | 35,000 | 350,000 | 3,500,000 | 35,000,000 | 350,000,000 |
| d | 0.40 | 4.0 | 40 | 400 | 4,000 | 40,000 | 400,000 | 4,000,000 | 40,000,000 | 400,000,000 |
| e | 0.45 | 4.5 | 45 | 450 | 4,500 | 45,000 | 450,000 | 4,500,000 | 45,000,000 | 450,000,000 |
| f | 0.50 | 5.0 | 50 | 500 | 5,000 | 50,000 | 500,000 | 5,000,000 | 50,000,000 | 500,000,000 |
| m | 0.60 | 6.0 | 60 | 600 | 6,000 | 60,000 | 600,000 | 6,000,000 | 60,000,000 | 600,000,000 |
| n | 0.70 | 7.0 | 70 | 700 | 7,000 | 70,000 | 700,000 | 7,000,000 | 70,000,000 | 700,000,000 |
| t | 0.80 | 8.0 | 80 | 800 | 8,000 | 80,000 | 800,000 | 8,000,000 | 80,000,000 | 800,000,000 |
| y | 0.90 | 9.0 | 90 | 900 | 9,000 | 90,000 | 900,000 | 9,000,000 | 90,000,000 | 900,000,000 |

Tape & Reel Packaging Information

KEMET offers multilayer ceramic chip capacitors packaged in 8, 12 and 16 mm tape on 7" and 13" reels in accordance with EIA Standard 481. This packaging system is compatible with all tape-fed automatic pick and place systems. See Table 2 for details on reeling quantities for commercial chips.



Table 5 – Carrier Tape Configuration, Embossed Plastic & Punched Paper (mm)

| EIA Case Size | Tape Size (W)* | Embossed Plastic | | Punched Paper | |
|-------------------|----------------|--------------------------|----------|--------------------------|----------|
| | | 7" Reel | 13" Reel | 7" Reel | 13" Reel |
| | | Pitch (P ₁)* | | Pitch (P ₁)* | |
| 01005 – 0402 | 8 | | | 2 | 2 |
| 0603 | 8 | | | 4 | 4 |
| 0805 | 8 | 4 | 4 | 4 | 4 |
| 1206 – 1210 | 8 | 4 | 4 | 4 | 4 |
| 1805 – 1808 | 12 | 4 | 4 | | |
| ≥ 1812 | 12 | 8 | 8 | | |
| KPS 1210 | 12 | 8 | 8 | | |
| KPS 1812 and 2220 | 16 | 12 | 12 | | |
| Array 0612 | 8 | 4 | 4 | | |

*Refer to Figures 1 and 2 for W and P₁ carrier tape reference locations.

*Refer to Tables 6 and 7 for tolerance specifications.

Figure 1 – Embossed (Plastic) Carrier Tape Dimensions



Table 6 – Embossed (Plastic) Carrier Tape Dimensions
Metric will govern

| Constant Dimensions – Millimeters (Inches) | | | | | | | | | |
|--|---------------------------------------|----------------------------------|------------------------------|-----------------------------|------------------------------|---------------------------|----------------------------------|--|---------------------------|
| Tape Size | D ₀ | D ₁ Minimum Note 1 | E ₁ | P ₀ | P ₂ | R Reference Note 2 | S ₁ Minimum Note 3 | T Maximum | T ₁ Maximum |
| 8 mm | 1.5 +0.10/-0.0 (0.059 +0.004/-0.0) | 1.0 (0.039) | 1.75 ±0.10 (0.069 ±0.004) | 4.0 ±0.10 (0.157 ±0.004) | 2.0 ±0.05 (0.079 ±0.002) | 25.0 (0.984) | 0.600 (0.024) | 0.600 (0.024) | 0.100 (0.004) |
| 12 mm | | 1.5 (0.059) | | | | 30 (1.181) | | | |
| 16 mm | | | | | | | | | |
| Variable Dimensions – Millimeters (Inches) | | | | | | | | | |
| Tape Size | Pitch | B ₁ Maximum Note 4 | E ₂ Minimum | F | P ₁ | T ₂ Maximum | W Maximum | A ₀ , B ₀ & K ₀ | |
| 8 mm | Single (4 mm) | 4.35 (0.171) | 6.25 (0.246) | 3.5 ±0.05 (0.138 ±0.002) | 4.0 ±0.10 (0.157 ±0.004) | 2.5 (0.098) | 8.3 (0.327) | Note 5 | |
| 12 mm | Single (4 mm) and double (8 mm) | 8.2 (0.323) | 10.25 (0.404) | 5.5 ±0.05 (0.217 ±0.002) | 8.0 ±0.10 (0.315 ±0.004) | 4.6 (0.181) | 12.3 (0.484) | | |
| 16 mm | Triple (12 mm) | 12.1 (0.476) | 14.25 (0.561) | 7.5 ±0.05 (0.138 ±0.002) | 12.0 ±0.10 (0.157 ±0.004) | 4.6 (0.181) | 16.3 (0.642) | | |

1. The embossment hole location shall be measured from the sprocket hole controlling the location of the embossment. Dimensions of the embossment location and the hole location shall be applied independently of each other.
2. The tape with or without components shall pass around R without damage (see Figure 6.)
3. If S₁ < 1.0 mm, there may not be enough area for a cover tape to be properly applied (see EIA Standard 481, paragraph 4.3, section b.)
4. B₁ dimension is a reference dimension for tape feeder clearance only.
5. The cavity defined by A₀, B₀ and K₀ shall surround the component with sufficient clearance that:
 - (a) the component does not protrude above the top surface of the carrier tape.
 - (b) the component can be removed from the cavity in a vertical direction without mechanical restriction, after the top cover tape has been removed.
 - (c) rotation of the component is limited to 20° maximum for 8 and 12 mm tapes and 10° maximum for 16 mm tapes (see Figure 3.)
 - (d) lateral movement of the component is restricted to 0.5 mm maximum for 8 and 12 mm wide tape and to 1.0 mm maximum for 16 mm tape (see Figure 4.)
 - (e) for KPS product, A₀ and B₀ are measured on a plane 0.3 mm above the bottom of the pocket.
 - (f) see addendum in EIA Standard 481 for standards relating to more precise taping requirements.

Figure 2 – Punched (Paper) Carrier Tape Dimensions

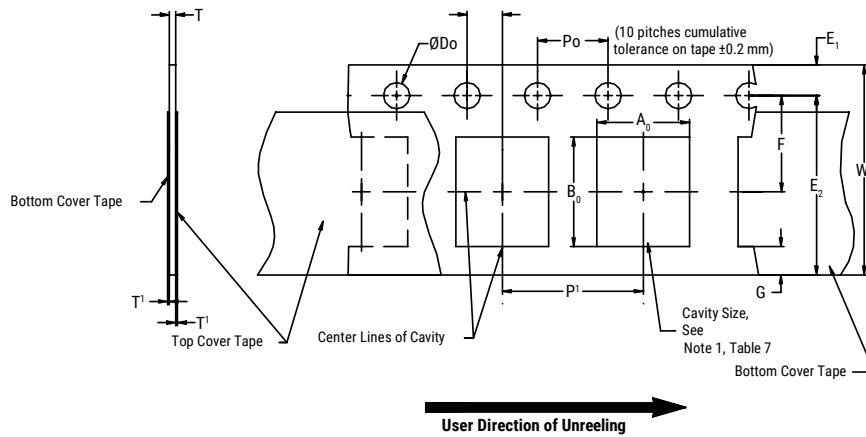

Table 7 – Punched (Paper) Carrier Tape Dimensions

Metric will govern

| Constant Dimensions – Millimeters (Inches) | | | | | | | |
|--|---------------------------------------|------------------------------|-----------------------------|-----------------------------|----------------------------|-----------------|--------------------|
| Tape Size | D_0 | E_1 | P_0 | P_2 | T_1 Maximum | G Minimum | R Reference Note 2 |
| 8 mm | 1.5 +0.10 -0.0 (0.059 +0.004 -0.0) | 1.75 ±0.10 (0.069 ±0.004) | 4.0 ±0.10 (0.157 ±0.004) | 2.0 ±0.05 (0.079 ±0.002) | 0.10 (0.004) maximum | 0.75 (0.030) | 25 (0.984) |
| Variable Dimensions – Millimeters (Inches) | | | | | | | |
| Tape Size | Pitch | E2 Minimum | F | P_1 | T Maximum | W Maximum | $A_0 B_0$ |
| 8 mm | Half (2 mm) | 6.25 (0.246) | 3.5 ±0.05 (0.138 ±0.002) | 2.0 ±0.05 (0.079 ±0.002) | 1.1 (0.098) | 8.3 (0.327) | Note 1 |
| 8 mm | Single (4 mm) | | | 4.0 ±0.10 (0.157 ±0.004) | | | |

- The cavity defined by A_0 , B_0 and T shall surround the component with sufficient clearance that:
 - the component does not protrude beyond either surface of the carrier tape.
 - the component can be removed from the cavity in a vertical direction without mechanical restriction, after the top cover tape has been removed.
 - rotation of the component is limited to 20° maximum (see Figure 3.)
 - lateral movement of the component is restricted to 0.5 mm maximum (see Figure 4.)
 - see addendum in EIA Standard 481 for standards relating to more precise taping requirements.
- The tape with or without components shall pass around R without damage (see Figure 6.)

Packaging Information Performance Notes

- Cover Tape Break Force:** 1.0 kg minimum.
- Cover Tape Peel Strength:** The total peel strength of the cover tape from the carrier tape shall be:

| Tape Width | Peel Strength |
|--------------|----------------------------------|
| 8 mm | 0.1 to 1.0 newton (10 to 100 gf) |
| 12 and 16 mm | 0.1 to 1.3 newton (10 to 130 gf) |

The direction of the pull shall be opposite the direction of the carrier tape travel. The pull angle of the carrier tape shall be 165° to 180° from the plane of the carrier tape. During peeling, the carrier and/or cover tape shall be pulled at a velocity of 300 ±10 mm/minute.

- Labeling:** Bar code labeling (standard or custom) shall be on the side of the reel opposite the sprocket holes. Refer to EIA Standards 556 and 624.

Figure 3 – Maximum Component Rotation

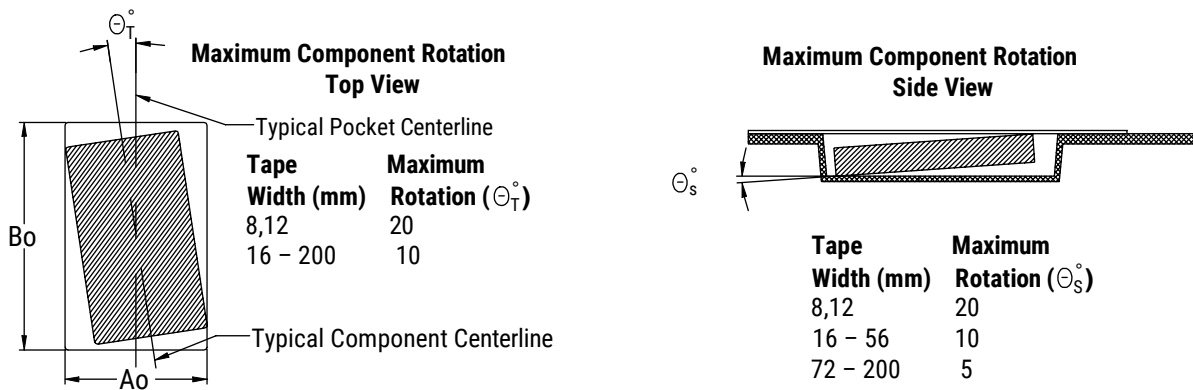

Figure 4 – Maximum Lateral Movement

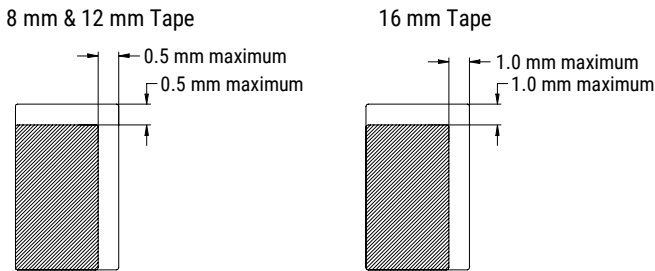

Figure 5 – Bending Radius

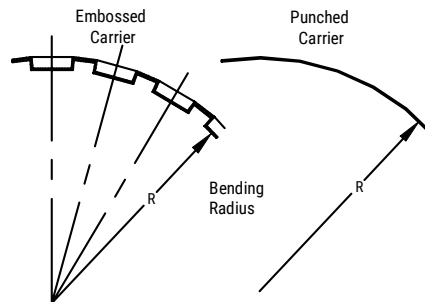

Figure 6 – Reel Dimensions



Note: Drive spokes optional; if used, dimensions B and D shall apply.

Table 8 – Reel Dimensions

Metric will govern

| Constant Dimensions – Millimeters (Inches) | | | | |
|--|------------------------------|---------------------------------------|--|---|
| Tape Size | A | B Minimum | C | D Minimum |
| 8 mm | 178 ±0.20 (7.008 ±0.008) | 1.5 (0.059) | 13.0 +0.5/-0.2 (0.521 +0.02/-0.008) | 20.2 (0.795) |
| 12 mm | or | | | |
| 16 mm | 330 ±0.20 (13.000 ±0.008) | | | |
| Variable Dimensions – Millimeters (Inches) | | | | |
| Tape Size | N Minimum | W ₁ | W ₂ Maximum | W ₃ |
| 8 mm | 50 (1.969) | 8.4 +1.5/-0.0 (0.331 +0.059/-0.0) | 14.4 (0.567) | Shall accommodate tape width without interference |
| 12 mm | | 12.4 +2.0/-0.0 (0.488 +0.078/-0.0) | 18.4 (0.724) | |
| 16 mm | | 16.4 +2.0/-0.0 (0.646 +0.078/-0.0) | 22.4 (0.882) | |

Figure 7 – Tape Leader & Trailer Dimensions



Figure 8 – Maximum Camber



KEMET Electronics Corporation Sales Offices

For a complete list of our global sales offices, please visit www.kemet.com/sales.

Disclaimer

YAGEO Corporation and its affiliates do not recommend the use of commercial or automotive grade products for high reliability applications or manned space flight.

All product specifications, statements, information and data (collectively, the "Information") in this datasheet are subject to change. The customer is responsible for checking and verifying the extent to which the Information contained in this publication is applicable to an order at the time the order is placed. All Information given herein is believed to be accurate and reliable, but it is presented without guarantee, warranty, or responsibility of any kind, expressed or implied.

Statements of suitability for certain applications are based on KEMET Electronics Corporation's ("KEMET") knowledge of typical operating conditions for such applications, but are not intended to constitute – and KEMET specifically disclaims – any warranty concerning suitability for a specific customer application or use. The Information is intended for use only by customers who have the requisite experience and capability to determine the correct products for their application. Any technical advice inferred from this Information or otherwise provided by KEMET with reference to the use of KEMET's products is given gratis, and KEMET assumes no obligation or liability for the advice given or results obtained.

Although KEMET designs and manufactures its products to the most stringent quality and safety standards, given the current state of the art, isolated component failures may still occur. Accordingly, customer applications which require a high degree of reliability or safety should employ suitable designs or other safeguards (such as installation of protective circuitry or redundancies) in order to ensure that the failure of an electrical component does not result in a risk of personal injury or property damage.

Although all product-related warnings, cautions and notes must be observed, the customer should not assume that all safety measures are indicated or that other measures may not be required.

KEMET is a registered trademark of KEMET Electronics Corporation.