

# Active Multiband GNSS External Antenna



AEACBD050018-SG3



50.0 x 50.0 x 18.0 mm  
RoHS/RoHS II Compliant  
MSL = 1

## Features

- High positioning accuracy
- GPS/GLONASS/BeiDou/Galileo band support
- IP67 Rated
- Gain of 5.0 dBic
- Active GNSS with integrated LNA
- High LNA gain of 34 dB
- Low VSWR of 1.5
- RHCP polarization
- Magnetic mounting
- Improved GNSS reliability

## Applications

- GPS/GLONASS/BeiDou/Galileo applications
- IoT
- M2M
- Surveillance
- Fleet management and asset tracking
- Autonomous driving
- Telematics
- Agriculture
- Instrumentation
- Survey

## Electrical Specifications

Parameters	Min.	Typ.	Max.	Units	Note
Frequency Range		1561.098 ~ 1602		MHz	
VSWR			1.5		
Polarization		RHCP			Right Hand Circular Polarization
Impedance		50		$\Omega$	
Gain		5		dBic	@PCB Zenith
Axial Ratio			3	dB	

LNA Parameters	Min.	Typ.	Max.	Units	Note
Gain	32	34	36	dB	
VSWR			2.0		
Noise Figure			1.5	dB	
Supply Voltage		3~5		V	DC
Current Consumption			20	mA	

## Mechanical Characteristics

Parameters	Description
Connector	SMA
Cable Type	RG174/3M
Mounting	Magnet
Radom Material	ABS

# Active Multiband GNSS External Antenna



AEACBD050018-SG3



50.0 x 50.0 x 18.0 mm  
RoHS/RoHS II Compliant  
MSL = 1

## Environmental Characteristics

Parameters	Description
Ingress Protection	IP67 rated
Operating temperature	-40°C to +85°C
Relative Humidity	Up to 95 %
Vibration	10 to 55 Hz with 1.5 mm amplitude 2 hours

## Dimensions

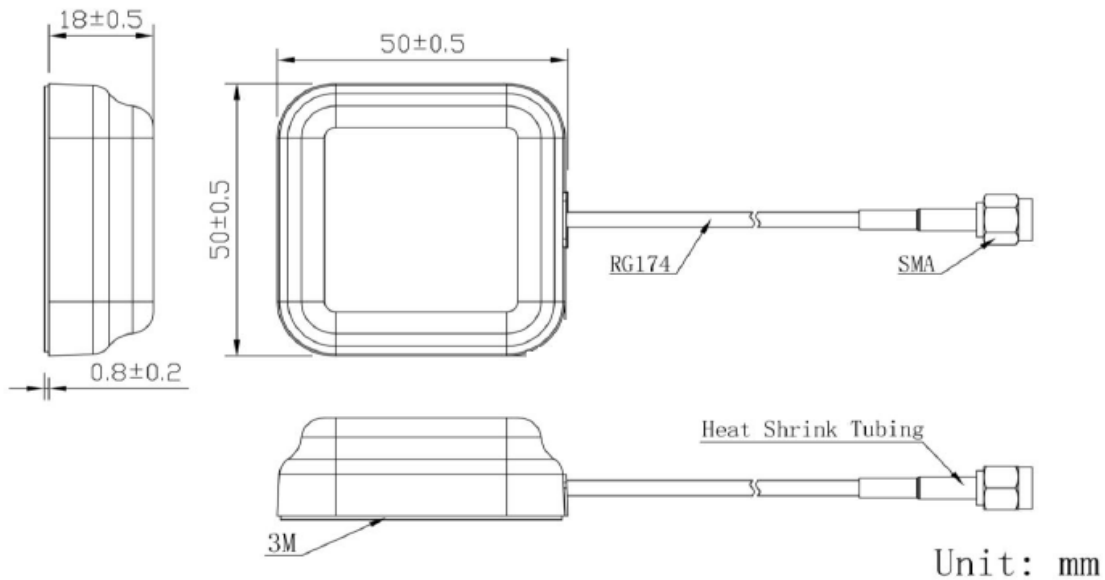

## Product Image



# Active Multiband GNSS External Antenna



AEACBD050018-SG3



50.0 x 50.0 x 18.0 mm  
RoHS/RoHS II Compliant  
MSL = 1

## VSWR

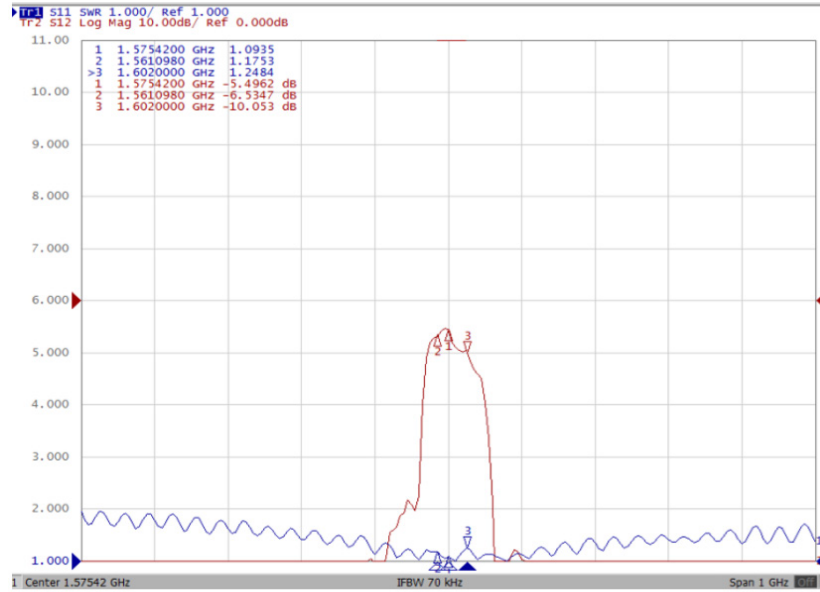

## Radiation Patterns:

### 2D- Pattern

Frequency: --- 1561 --- 1575 --- 1602

### XY - Plane

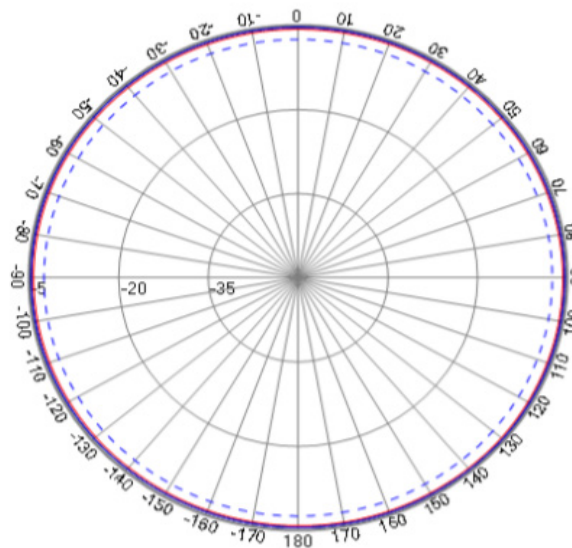

**ATTENTION:** Abracon LLC's products are COTS – Commercial-Off-The-Shelf products; suitable for Commercial, Industrial and, where designated, Automotive Applications. Abracon's products are not specifically designed for Military, Aviation, Aerospace, Life-dependent Medical applications or any application requiring high reliability where component failure could result in loss of life and/or property. For applications requiring high reliability and/or presenting an extreme operating environment, written consent and authorization from Abracon LLC is required. Please contact Abracon LLC for more information.



5101 Hidden Creek Ln Spicewood TX 78669  
Phone: 512-371-6159 | Fax: 512-351-8858  
For terms and conditions of sales, please visit:  
[www.abracon.com](http://www.abracon.com)

REVISED: 01.25.2019

ABRACON IS  
ISO9001-2015  
CERTIFIED

# Active Multiband GNSS External Antenna



AEACBD050018-SG3



50.0 x 50.0 x 18.0 mm  
RoHS/RoHS II Compliant  
MSL = 1

## Radiation Patterns:

XZ - Plane

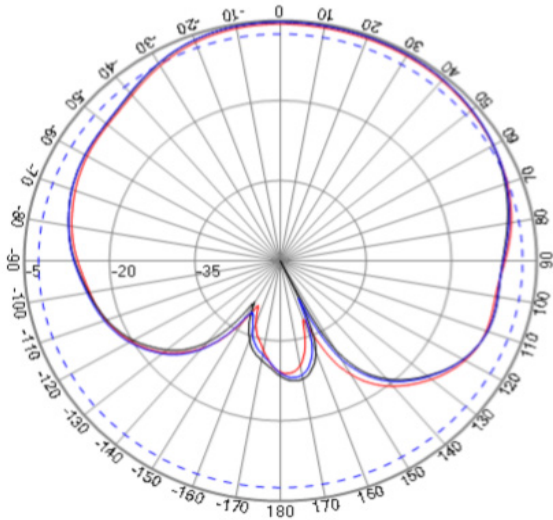

YZ - Plane

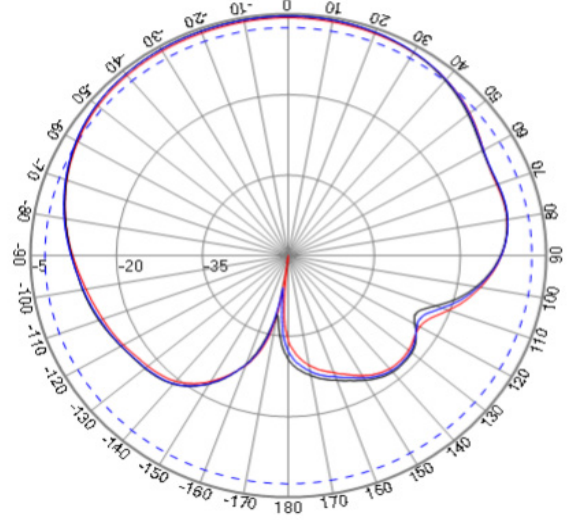

## 3D- Pattern

Frequency: 1561 MHz

Frequency: 1575.42 MHz

Frequency: 1602 MHz

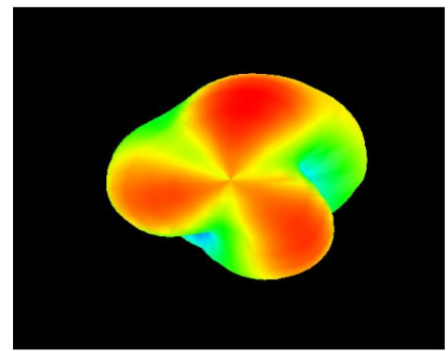
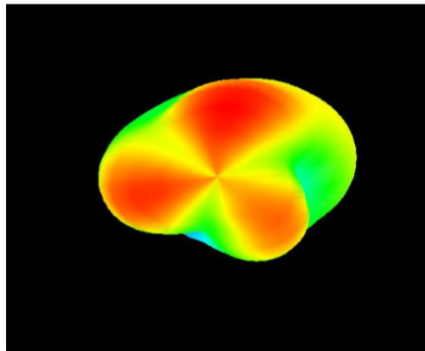
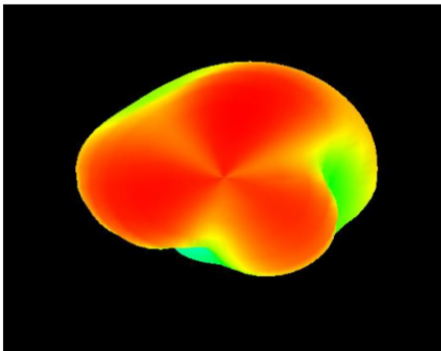

## Packaging

The carton weighs of 15 Kgs and has 100 pieces in a dimension of 70.0 x 32.0 x 16.0 cm.



5101 Hidden Creek Ln Spicewood TX 78669  
Phone: 512-371-6159 | Fax: 512-351-8858  
For terms and conditions of sales, please visit:  
[www.abracon.com](http://www.abracon.com)

REVISED: 01.25.2019

ABRACON IS  
ISO9001-2015  
CERTIFIED

# Mouser Electronics

Authorized Distributor

Click to View Pricing, Inventory, Delivery & Lifecycle Information:

[ABRACON:](#)

[AEACBD050018-SG3](#)