



The Future of Analog IC Technology®

MP9486

100V Input, 1A, Step-Down Converter

DESCRIPTION

The MP9486 is a high-voltage, step-down, switching regulator that delivers up to 1A of continuous current to the load. It integrates a high-side, high-voltage, power MOSFET with a current limit of 2.5A, typically. The wide 4.5V to 100V input range accommodates a variety of step-down applications, making it ideal for automotive, industry, and lighting applications. Hysteretic voltage-mode control is employed for very fast response. MPS's proprietary feedback control scheme minimizes the number of required external components.

The switching frequency can be up to 1MHz, allowing for small component size. Thermal shutdown and short-circuit protection (SCP) provide reliable and fault-tolerant operations. A 170 μ A quiescent current allows the MP9486 to be used in battery-powered applications.

The MP9486 is available in a SOIC-8 package with an exposed pad.

FEATURES

- Wide 4.5V to 100V Input Range
- Hysteretic Control: No Compensation
- Up to 1MHz Switching Frequency
- PWM Dimming Control Input for LED Application
- Short-Circuit Protection (SCP) with Integrated High-Side MOSFET
- 170 μ A Quiescent Current
- Thermal Shutdown
- Available in a SOIC-8 Package with an Exposed Pad

APPLICATIONS

- Scooters, E-Bike Control Power Supplies
- Solar Energy Systems
- Automotive System Power
- Industrial Power Supplies
- High-Power LED Drivers

All MPS parts are lead-free, halogen-free, and adhere to the RoHS directive. For MPS green status, please visit the MPS website under Quality Assurance. "MPS" and "The Future of Analog IC Technology" are registered trademarks of Monolithic Power Systems, Inc.

TYPICAL APPLICATION

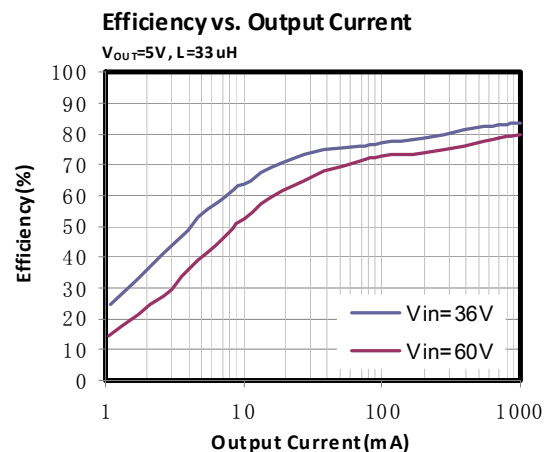
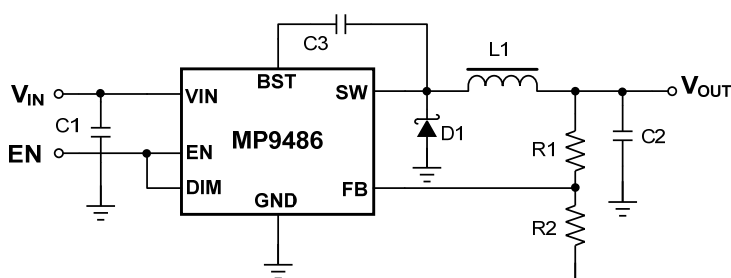

ORDERING INFORMATION

Part Number*	Package	Top Marking
MP9486GN	SOIC-8 EP	See Below

* For Tape & Reel, add suffix -Z (e.g. MP9486GN-Z)

TOP MARKING

MP9486
LLLLLLLL
MPSYWW

MP9486: Part number
 LLLLLLLL: Lot number
 MPS: MPS prefix
 Y: Year code
 WW: Week code

PACKAGE REFERENCE

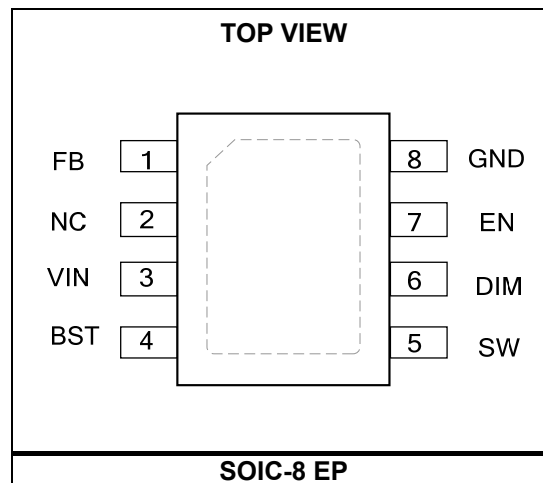

ABSOLUTE MAXIMUM RATINGS ⁽¹⁾

Supply voltage (VIN).....	-0.3V to +100V
Switch voltage (V _{SW})	-0.5V (-4.5V for 10ns) to VIN + 0.5V
BST to SW	-0.3V to +6V
All other pins	-0.3V to +6V
Junction temperature	150°C
Continuous power dissipation (T _A = +25°C) ⁽²⁾	3.6W ⁽⁴⁾
Lead temperature.....	260°C
Storage temperature	-65°C to +150°C
Recommended Operating Conditions ⁽³⁾	
Supply voltage (VIN).....	4.5V to 95V
EN and DIM voltages	0V to 5V
Maximum switching frequency	1MHz
Operating junction temp. (T _J).....	-40°C to +125°C

Thermal Resistance	θ_{JA}	θ_{JC}
SOIC-8 EP		
EV9486-N-00A ⁽⁴⁾	34	4 ... °C/W
JESD51-7 ⁽⁵⁾	50	10 ... °C/W

NOTES:

- 1) Exceeding these ratings may damage the device.
- 2) The maximum allowable power dissipation is a function of the maximum junction temperature T_J(MAX), the junction-to-ambient thermal resistance θ_{JA}, and the ambient temperature T_A. The maximum allowable continuous power dissipation at any ambient temperature is calculated by P_D(MAX)=(T_J(MAX)-T_A)/θ_{JA}. Exceeding the maximum allowable power dissipation produces an excessive die temperature, causing the regulator to go into thermal shutdown. Internal thermal shutdown circuitry protects the device from permanent damage.
- 3) The device is not guaranteed to function outside of its operating conditions.
- 4) Measured on EV9486-N-00A 2-layer 63mmx63mm board.
- 5) Measured on JESD51-7 4-layer board.

ELECTRICAL CHARACTERISTICS

VIN = 60V, TA = +25°C, unless otherwise noted. Specifications over temperature are guaranteed by design and characterization.

Parameter	Symbol	Condition	Min	Typ	Max	Units
VIN UVLO threshold			3.6	4.0	4.35	V
VIN UVLO hysteresis				0.4		V
Shutdown supply current		V _{EN} = 0V		2	5	μA
Quiescent supply current		No load, DIM = low, V _{FB} = 250mV		170	240	μA
Upper switch on resistance ⁽⁶⁾	R _{DSON}	V _{BST} - V _{SW} = 5V		500		mΩ
Upper switch leakage current	I _{SWLK}	V _{EN} = 0V, V _{SW} = 0V		0.01	1	μA
Current limit	I _{PK}	V _{FB} = 0.15V	1.7	2.5		A
EN up threshold	V _{ENH}		1.4	1.55	1.7	V
EN threshold hysteresis	V _{ENHY}			320		mV
EN input current	I _{ENI}	V _{EN} = 5V		0.01	1	μA
EN pull-up current	I _{ENS}	V _{EN} = 2V		2	3	μA
DIM up threshold	V _{DIMH}		0.8	1.15	1.5	V
DIM threshold hysteresis	V _{DIMHY}			300		mV
DIM input current	I _{DIM}	V _{DIM} = 5V or 0V	-1		1	μA
DIM on propagation delay	T _{DIMDH}	V _{FB} = 0V, V _{DIM} rising edge to V _{SW} rising edge		50		ns
DIM off propagation delay	T _{DIMDL}	V _{FB} = 0V, V _{DIM} falling edge to V _{SW} falling edge		50		ns
Feedback voltage threshold high ⁽⁶⁾	V _{FBH}	4.5V < VIN < 95V, V _{FB} rising from 0V until V _{SW} < 30V	209	215	221	mV
Feedback voltage threshold low ⁽⁶⁾	V _{FBL}	4.5V < VIN < 95V, V _{FB} falling from 0.25V until V _{SW} > 30V	179	185	191	mV
FB input current	I _{FB}	V _{FB} = 5V or 0V	-300		300	nA
FB propagation delay to output high	T _{FBDH}	Falling edge of V _{FB} from 0.25V to 0V to V _{SW} rising edge		100		ns
FB propagation delay to output high	T _{FBDL}	Rising edge of V _{FB} from 0V to 0.25V to V _{SW} falling edge		100		ns
Thermal shutdown ⁽⁷⁾		Trigger thermal shutdown		150		°C
		Hysteresis		20		

NOTES:

6) Guaranteed by design.

7) Guaranteed by characterization, not tested in production.

TYPICAL CHARACTERISTICS

V_{IN} = 60V, T_A = +25°C, unless otherwise noted.

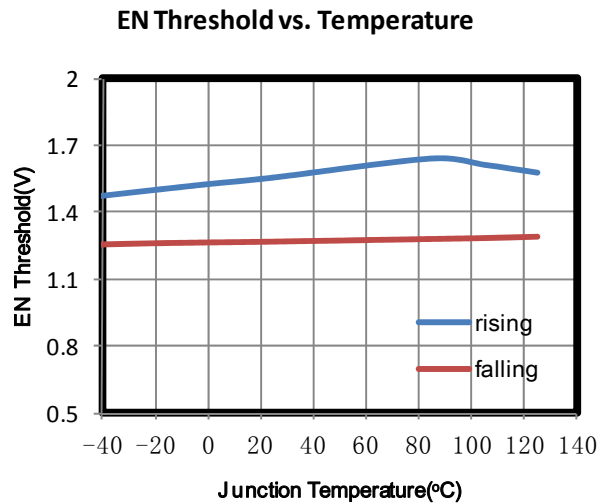
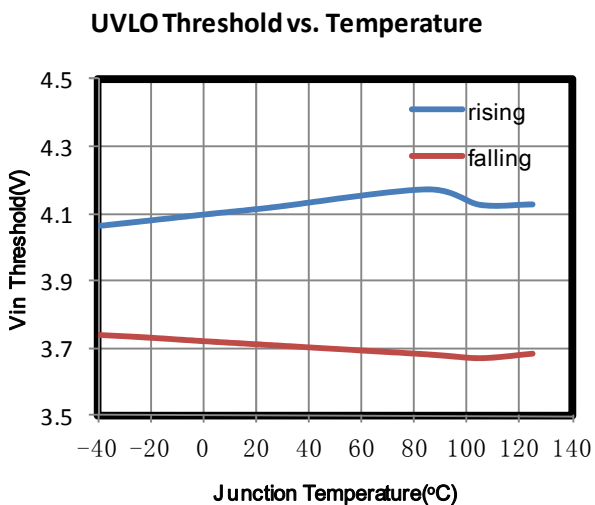
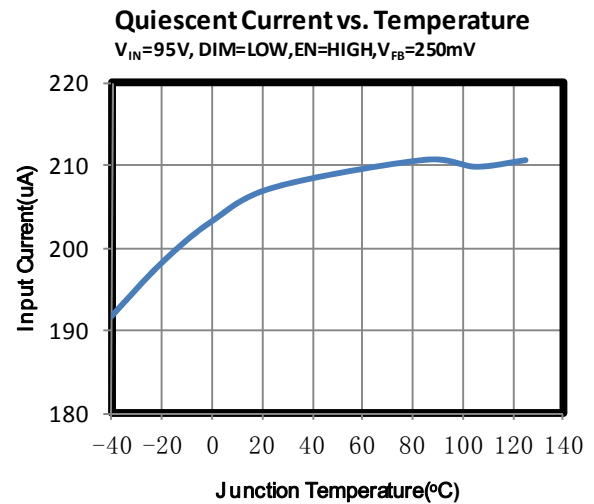
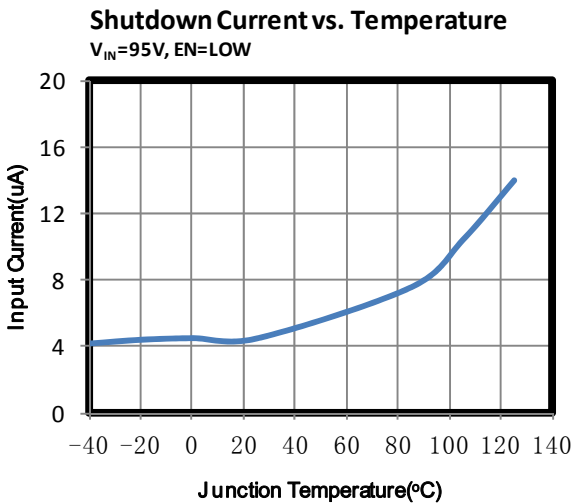
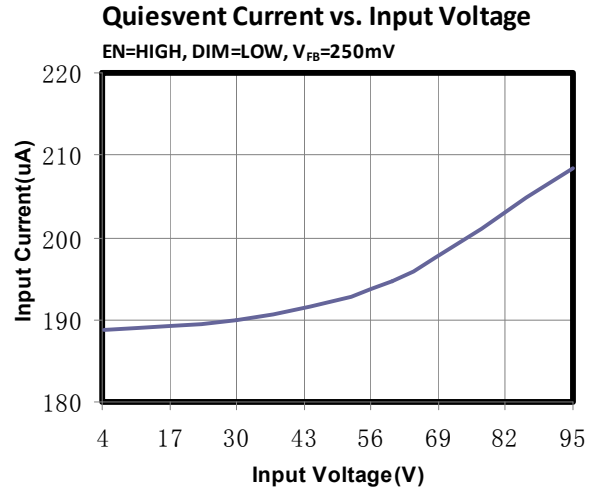
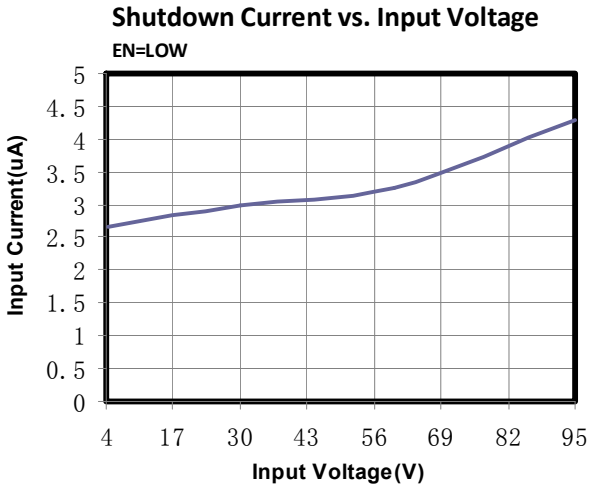

TYPICAL PERFORMANCE CHARACTERISTICS

V_{IN} = 60V, V_{OUT} = 5V, I_{OUT} = 1A, L = 33μH, C_{OUT} = 100μF, T_A = +25°C, unless otherwise noted.

Efficiency vs. Output Current

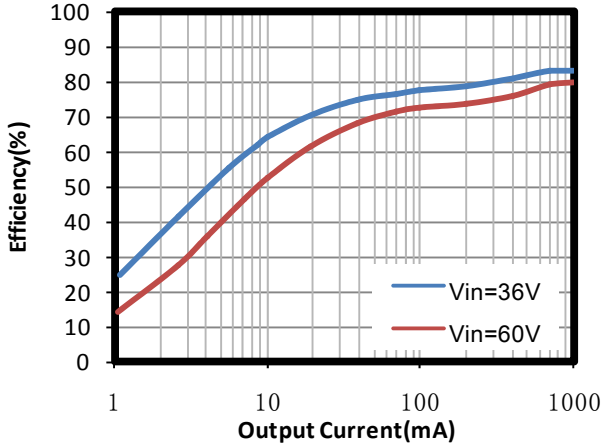

Load Regulation

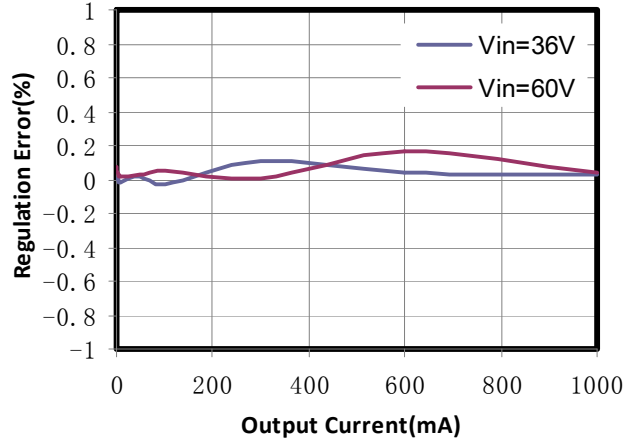

Line Regulation

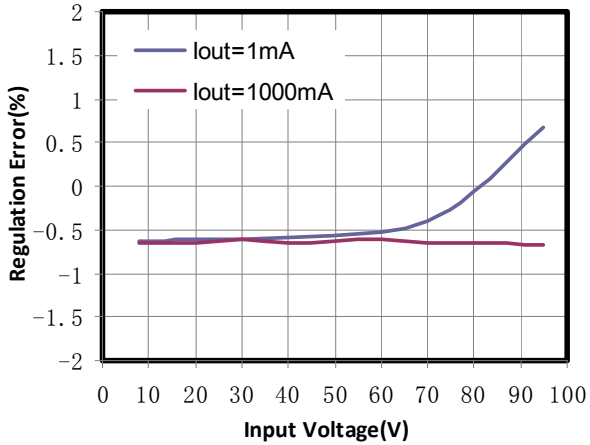

TYPICAL PERFORMANCE CHARACTERISTICS (continued)

V_{IN} = 60V, V_{OUT} = 5V, I_{OUT} = 1A, L = 33μH, C_{OUT} = 100μF, T_A = +25°C, unless otherwise noted.

Steady State

I_{OUT} = 0A

CH1: V_{out/AC}
100mV/div.
CH2: V_{IN}
50V/div.
CH3: V_{sw}
50V/div.
CH4: I_L
1A/div.

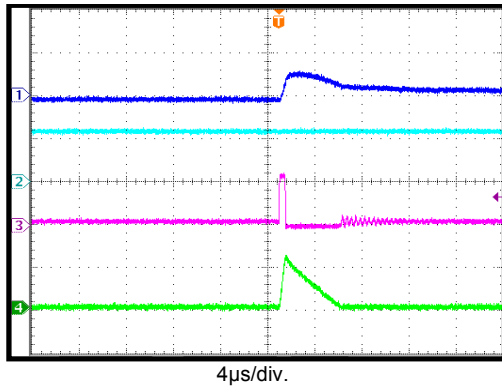

Steady State

I_{OUT} = 1A

CH1: V_{out/AC}
100mV/div.
CH2: V_{IN}
50V/div.
CH3: V_{sw}
50V/div.
CH4: I_L
2A/div.

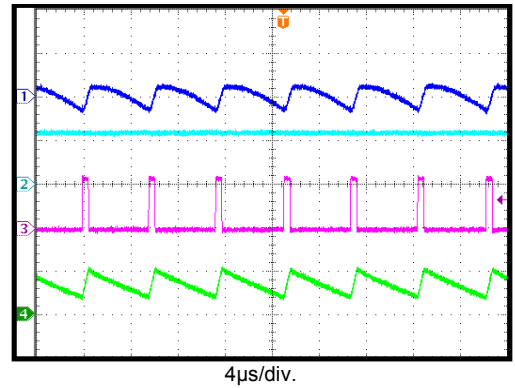

Power On

I_{OUT} = 0A

CH1: V_{out}
2V/div.
CH2: V_{IN}
50V/div.
CH3: V_{sw}
50V/div.
CH4: I_L
1A/div.

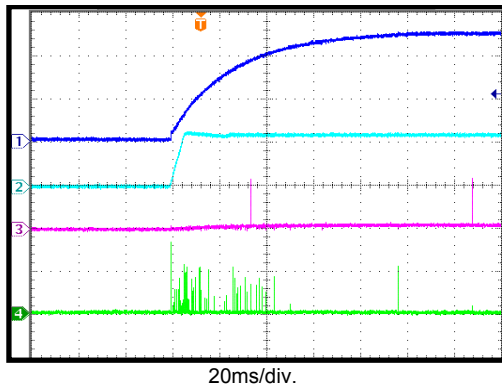

Power On

I_{OUT} = 1A

CH1: V_{out}
2V/div.
CH2: V_{IN}
50V/div.
CH3: V_{sw}
50V/div.
CH4: I_L
1A/div.

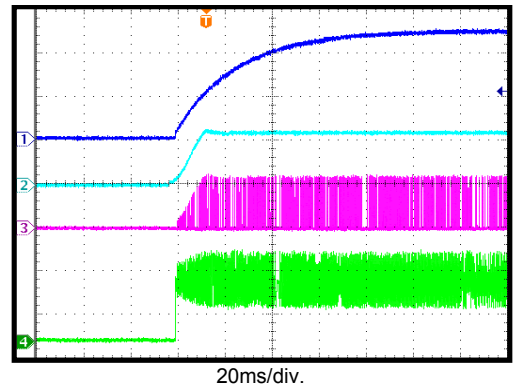

Power Off

I_{OUT} = 0A

CH1: V_{out}
2V/div.
CH2: V_{IN}
50V/div.
CH3: V_{sw}
10V/div.
CH4: I_L
500mA/div.

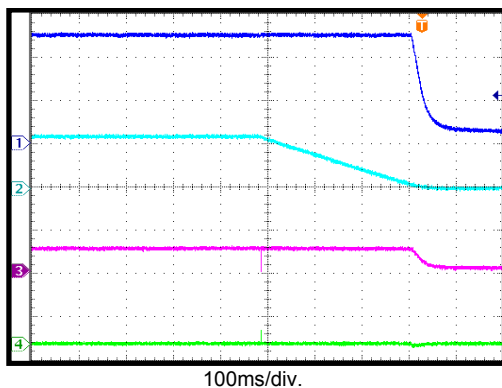

Power Off

I_{OUT} = 1A

CH1: V_{out}
2V/div.
CH2: V_{IN}
50V/div.
CH3: V_{sw}
50V/div.
CH4: I_L
1A/div.

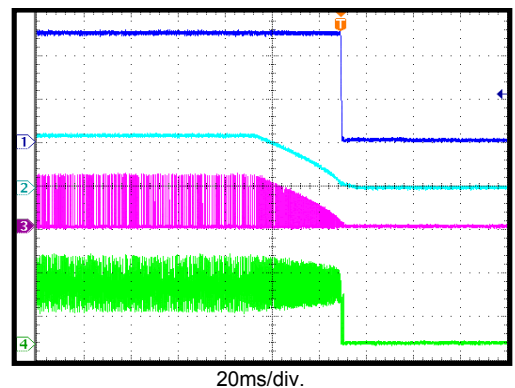

TYPICAL PERFORMANCE CHARACTERISTICS (continued)

$V_{IN} = 60V$, $V_{OUT} = 5V$, $I_{OUT} = 1A$, $L = 33\mu H$, $C_{OUT} = 100\mu F$, $T_A = +25^\circ C$, unless otherwise noted.

EN Start-Up

$I_{OUT} = 0A$

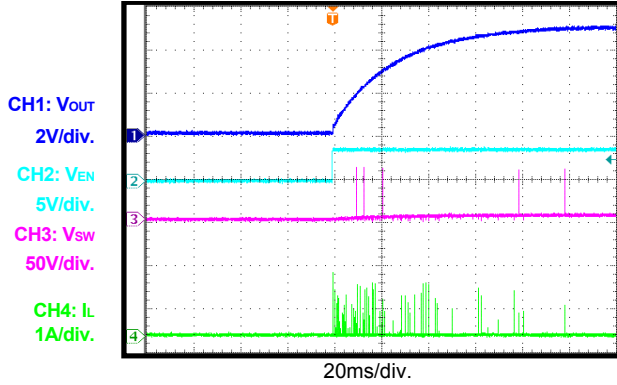

EN Start-Up

$I_{OUT} = 1A$

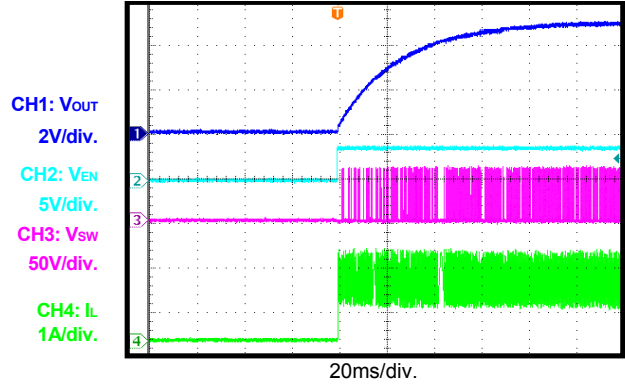

EN Shutdown

$I_{OUT} = 0A$

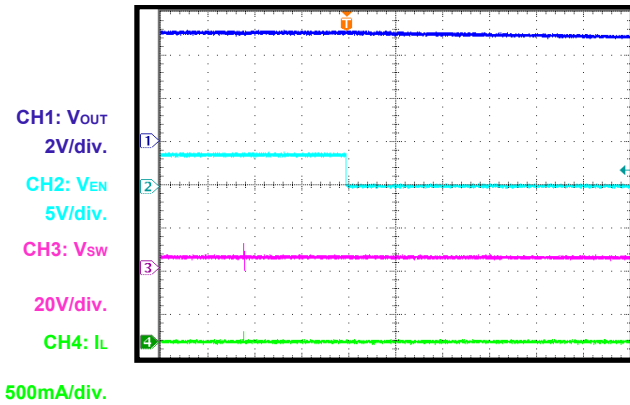

EN Shutdown

$I_{OUT} = 1A$

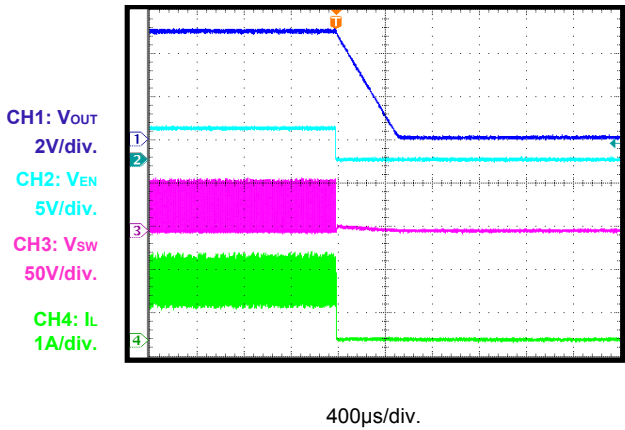

SCP Entry

$I_{OUT} = 0A$

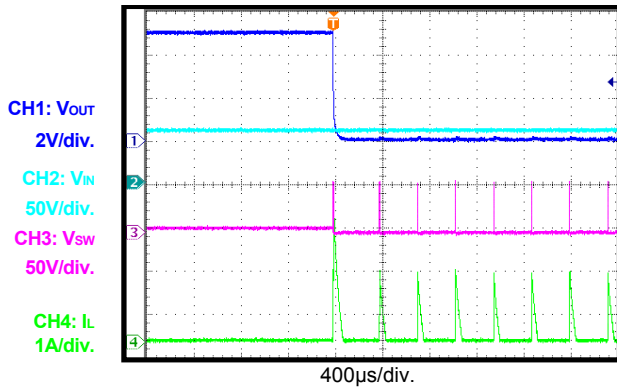

SCP Recovery

$I_{OUT} = 0A$

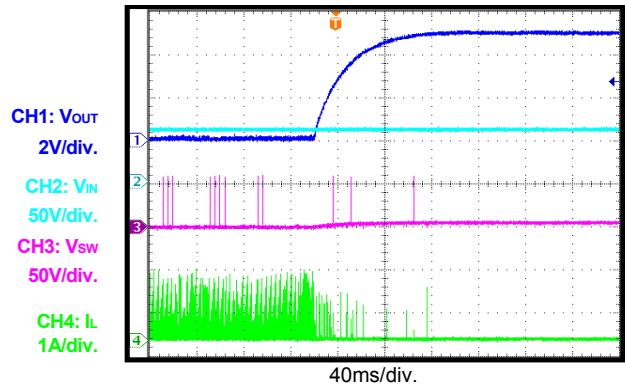

TYPICAL PERFORMANCE CHARACTERISTICS (continued)

V_{IN} = 60V, V_{OUT} = 5V, I_{OUT} = 1A, L = 33μH, C_{OUT} = 100μF, T_A = +25°C, unless otherwise noted.

SCP Entry

I_{OUT} = 1A

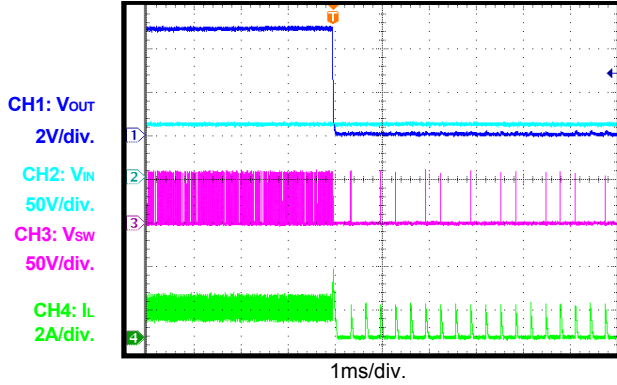

SCP Recovery

I_{OUT} = 1A, E-load turn-on threshold = 0.32V

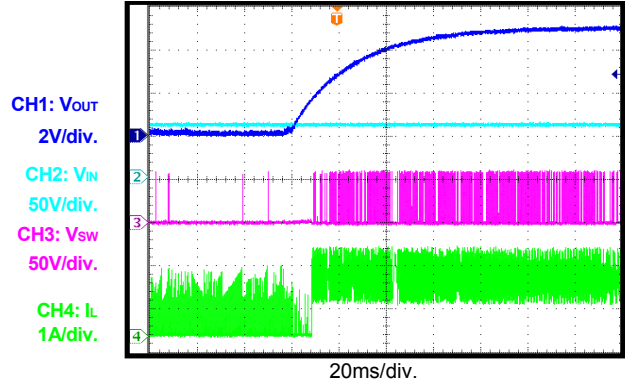

Load Transient

I_{OUT} = 0A --> 1A @ 70mA/μs

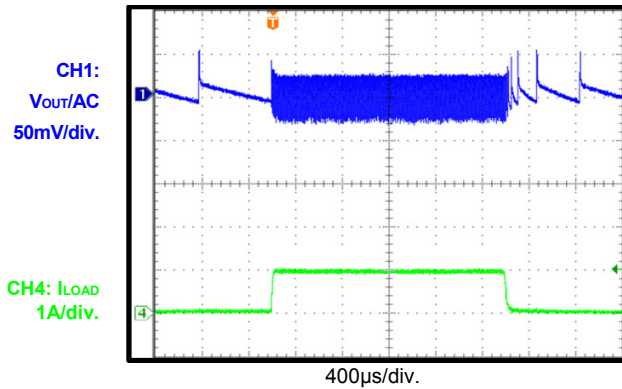

PIN FUNCTIONS

SOIC-8 EP Pin #	Name	Description
1	FB	Feedback. FB is the input to the voltage hysteretic comparators. The average FB voltage is maintained at 200mV by loop regulation.
2	NC	No connection.
3	VIN	Input supply. VIN supplies power to all of the internal control circuitries, both BST regulators, and the high-side switch. A decoupling capacitor to ground must be placed close to VIN to minimize switching spikes.
4	BST	Bootstrap. BST is the positive power supply for the internal, floating, high-side MOSFET driver. Connect a bypass capacitor between BST and SW.
5	SW	Switch node. SW is the output from the high-side switch. A low forward voltage Schottky rectifier to ground is required. The rectifier must be placed close to SW to reduce switching spikes.
6	DIM	PWM dimming input. DIM is useful in LED driver applications. Pull DIM below the specified threshold for dimming off. Pull DIM above the specified threshold for dimming on. If the dimming function is not needed, such as in common buck applications, then connect DIM and EN together.
7	EN	Enable input. Pull EN below the specified threshold to shut down the MP9486. Pull EN above the specified threshold or leave EN floating to enable the MP9486.
8	GND	Ground. GND should be placed as close to the output capacitor as possible to avoid the high-current switch paths. Connect the exposed pad to GND plane for optimal thermal performance.

BLOCK DIAGRAM

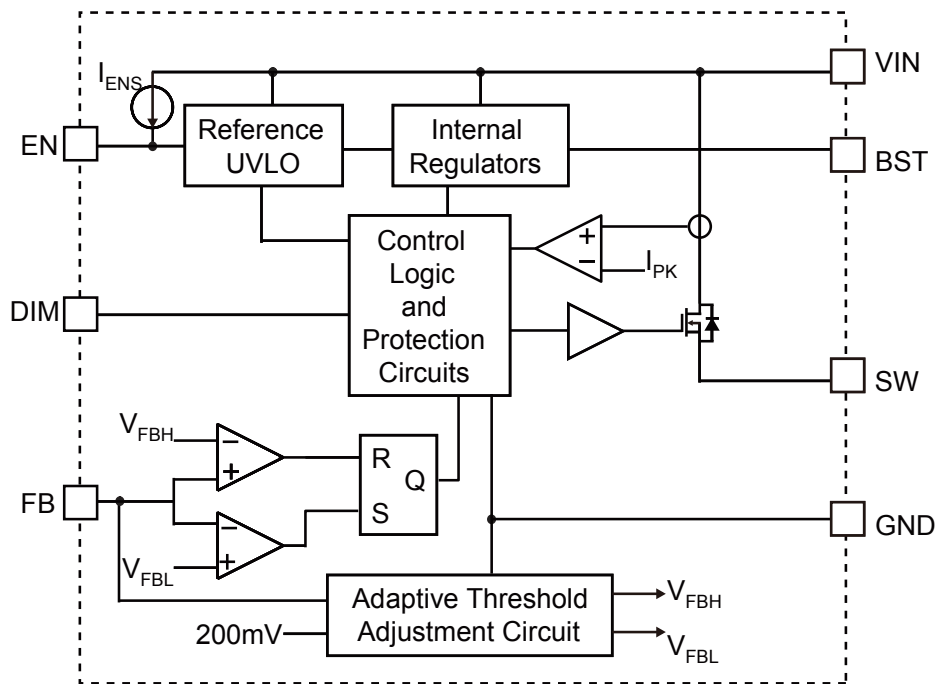

Figure 1: Function Block Diagram

OPERATION

Hysteresis Current Control with Adaptive Threshold Adjustment

The MP9486 operates in a hysteretic voltage-control mode to regulate the output voltage. FB is connected to the tap of a resistor divider, which determines the output voltage. The power MOSFET is turned on when the FB voltage (V_{FB}) drops to 185mV and remains on until V_{FB} rises to 215mV. The power MOSFET is turned off when V_{FB} rises to 215mV and remains off until V_{FB} falls to 185mV. The two thresholds of 215mV and 185mV are adjusted adaptively to compensate for all the circuit delays, so the output voltage is regulated with an average 200mV value at FB.

Enable (EN) Control

The MP9486 has a dedicated enable control pin (EN) with positive logic. Its falling threshold is 1.23V, and its rising threshold is 1.55V (320mV higher).

When floating, EN is pulled up to about 3V by an internal 2 μ A current source, so it is enabled. A current over 2 μ A is needed to pull EN down.

Floating Driver and Bootstrap Charging

The floating power MOSFET driver is powered by an external bootstrap capacitor. This floating driver has its own under-voltage lockout (UVLO) protection. The UVLO rising threshold is 2.2V with a threshold of 150mV.

The bootstrap capacitor is charged and regulated to about 5V by the dedicated internal bootstrap regulator.

If the internal circuit does not have sufficient voltage, and the bootstrap capacitor is not sufficiently charged, extra external circuitry can be used to ensure that the bootstrap voltage is in the normal operating region. Refer to the External Bootstrap Diode section on page 14 for more details.

Under-Voltage Lockout (UVLO)

Under-voltage lockout (UVLO) is implemented to protect the chip from operating at an insufficient supply voltage. The UVLO rising threshold is about 4V, while its falling threshold is a consistent 3.6V.

Dimming Function for LED Applications

Because the FB reference of the MP9486 is very low, it is recommended to use the MP9486 for LED drivers by connecting the LED current sense resistor between FB and GND. In such applications, the MP9486 uses DIM for dimming. To achieve dimming, apply a pulse on DIM. The high level of the pulse should be >1.5V, and the low level should be <0.5V. The frequency can be as high as 20kHz.

Thermal Shutdown

Thermal shutdown is implemented to prevent the chip from operating at exceedingly high temperatures. When the silicon die temperature is higher than its upper threshold, the entire chip shuts down. When the temperature is lower than its lower threshold, the chip is enabled again.

Output Short Protection

The output voltage is well-regulated when V_{FB} is around 200mV. If the output is pulled low in over-current protection (OCP) or is shorted to GND directly, V_{FB} is low, even though the power MOSFET is turned on. The MP9486 regards the low V_{FB} as a failure. The power MOSFET shuts off if the failure time is longer than 10 μ s. The MP9486 attempts operation again after a delay of about 300 μ s.

The power MOSFET current is also accurately sensed via a current sense MOSFET. If the current is over the current limit, the IC is shut down. This offers extra protection under output-short conditions.

APPLICATION INFORMATION

Setting the Output Voltage

The output voltage (V_{OUT}) is set by a resistor divider (R1 and R2) (see the Typical Application on page 1). To achieve good noise immunity and low power loss, R2 is recommended to be in the range of 5k Ω to 50k Ω . R1 can then be determined with Equation (1):

$$R1 = \frac{V_{OUT} - V_{FB}}{V_{FB}} \times R2 \quad (1)$$

Where V_{FB} is 0.2V, typically.

Output Capacitor and Frequency Setting

The output capacitor (C_{OUT}) is necessary for achieving a smooth output voltage. The ESR of the capacitor should be sufficiently large compared to the capacitance; otherwise, the system may behave in an unexpected way, and the current ripple may be very high. V_{FB} changes from 185mV to 215mV when the power MOSFET switches from on to off. To charge the capacitor and generate 215mV at FB, the system needs ESR and some inductor current. For example, for a 5V V_{OUT} , if the forward capacitor is 0.1 μ F, the suggested ESR range of the output capacitor is 100m Ω to 250m Ω . Tantalum or aluminum electrolytic capacitors with a small ceramic capacitor are recommended.

A forward capacitor across R1 is recommended when the output capacitor is tantalum or aluminum electrolytic, which can set the desired frequency if the output capacitor and ESR cannot be changed. The forward capacitor can reduce the output voltage ripple.

Selecting the Inductor

The inductor (L_O) is required to convert the switching voltage to a smooth current to the load. Although the output current is low, it is recommended that the inductor current be continuous in each switching period to prevent reaching the current limit. Calculate the inductor value with Equation (2):

$$L = \frac{(V_{IN} - V_{OUT}) \times V_{OUT}}{F_{SW} \times I_{OUT} \times V_{IN} \times K} \quad (2)$$

Where K is a coefficient of about 0.15 ~ 0.85.

Output Rectifier Diode

The output rectifier diode supplies current to the inductor when the high-side switch is off. To reduce losses due to the diode forward voltage and recovery times, use a Schottky diode.

The average current through the diode can be approximated with Equation (3):

$$I_D = I_{OUT} \times \left(1 - \frac{V_{OUT}}{V_{IN}} \right) \quad (3)$$

Choose a diode with a maximum reverse voltage rating greater than the maximum input voltage and a current rating is greater than the average diode current.

Input Capacitor (C_{IN})

The input current to the step-down converter is discontinuous and therefore requires a capacitor to supply AC current to the step-down converter while maintaining the DC input voltage. Use low ESR capacitors for the best performance, especially under high switching frequency applications.

The RMS current through the input capacitor can be calculated with Equation (4):

$$I_{IN_AC} = I_{OUT} \times \sqrt{\frac{V_{OUT}}{V_{IN}} \times \left(1 - \frac{V_{OUT}}{V_{IN}} \right)} \quad (4)$$

With low ESR capacitors, the input voltage ripple can be estimated with Equation (5):

$$\Delta V_{IN} = \frac{I_{OUT} \times V_{OUT}}{F_{SW} \times C_{IN} \times V_{IN}} \times \left(1 - \frac{V_{OUT}}{V_{IN}} \right) \quad (5)$$

Choose an input capacitor with enough RMS current rating and enough capacitance for small input voltage ripples.

When electrolytic or tantalum capacitors are applied, a small, high-quality ceramic capacitor (i.e.: 0.1 μ F) should be placed as close to the IC as possible.

External Bootstrap Diode

An external bootstrap diode may enhance the efficiency of the converter (see Figure 2). An external BST diode is recommended from the 5V supply to BST in the following cases:

- There is a 5V rail available in the system
- V_{IN} is not greater than 5V
- V_{OUT} is between 3.3V and 5V

This diode is also recommended for high duty cycle operations (when $V_{OUT} / V_{IN} > 65\%$) and very high frequency (close to 1MHz) applications.

The bootstrap diode can be a low-cost one, such as IN4148 or BAT54.

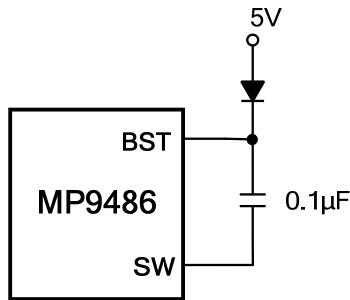

Figure 2: External Bootstrap Diode

PCB Layout Guidelines

Efficient PCB layout is critical for stable operation. For best results, refer to Figure 3 and follow the guidelines below.

1. Place the input decoupling capacitor, catch diode, and the MP9486 (V_{IN} , SW, and PGND) as close to each other as possible.
2. Keep the power traces very short and fairly wide, especially for the SW node.
This can help greatly reduce voltage spikes on the SW node and lower the EMI noise level.
3. Run the feedback trace as far from the inductor and noisy power traces (like the SW node) as possible.
4. Place thermal vias with 15mil barrel diameter and 40mil pitch (distance between the centers) under the exposed pad to improve thermal conduction.

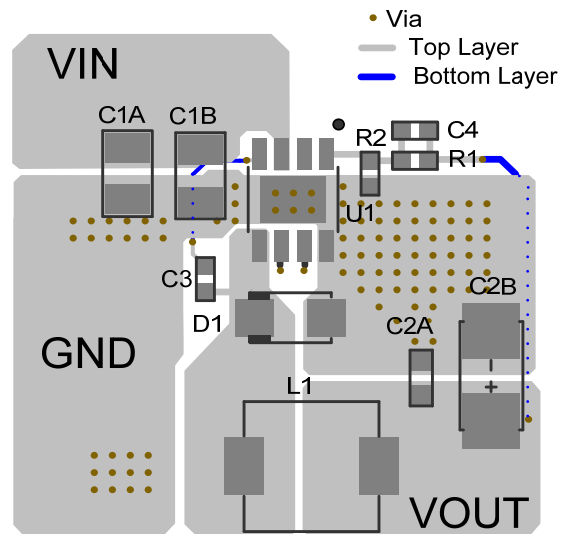

Figure 3: Recommended Layout

Design Example

Table 1 is a design example following the application guidelines for the specifications below.

Table 1: Design Example

V_{IN}	8V to 95V
V_{OUT}	5V
I_{OUT}	0A to 1A

The typical application circuit for $V_{OUT} = 5V$ in Figure 4 shows the detailed application schematic and is the basis for the typical performance waveforms. For more detailed device applications, please refer to the related evaluation board datasheets.

TYPICAL APPLICATION CIRCUIT

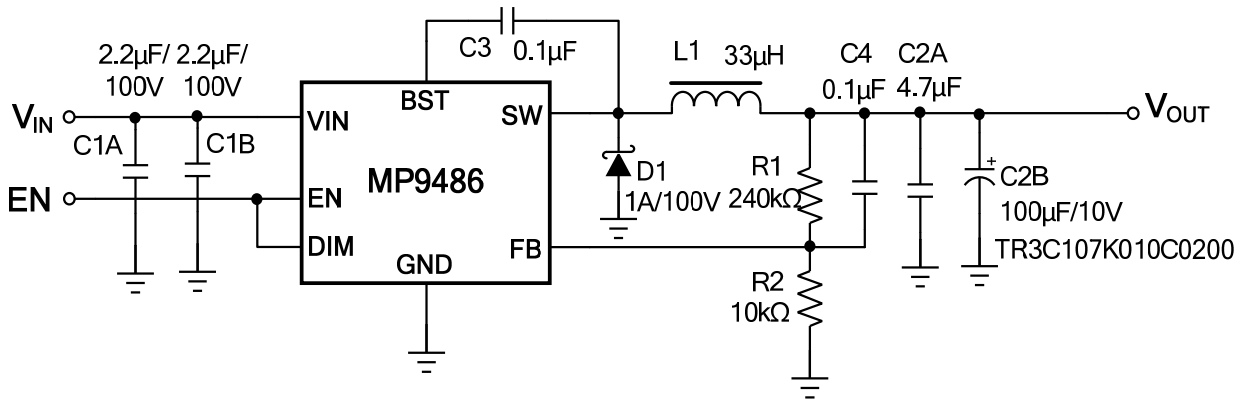
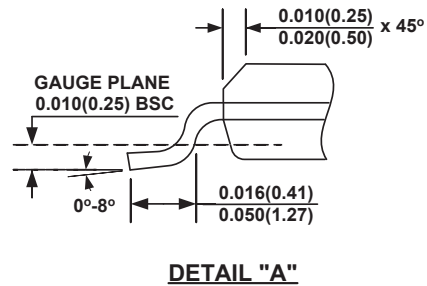
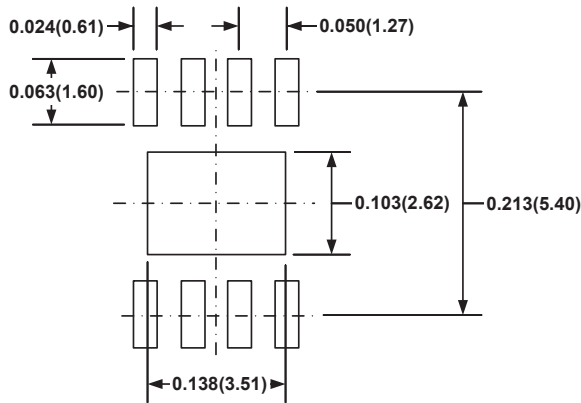
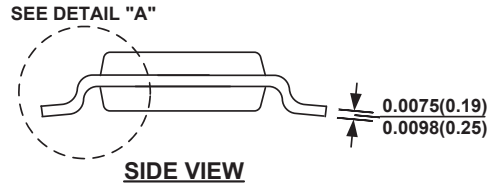
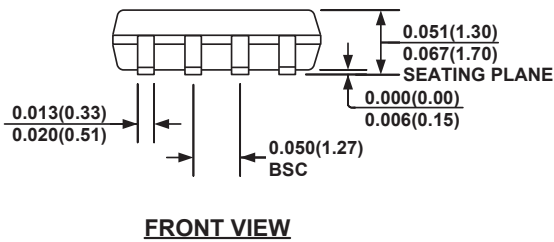
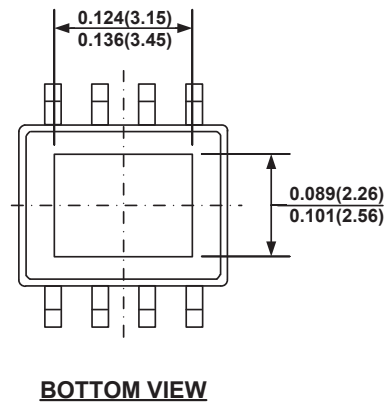
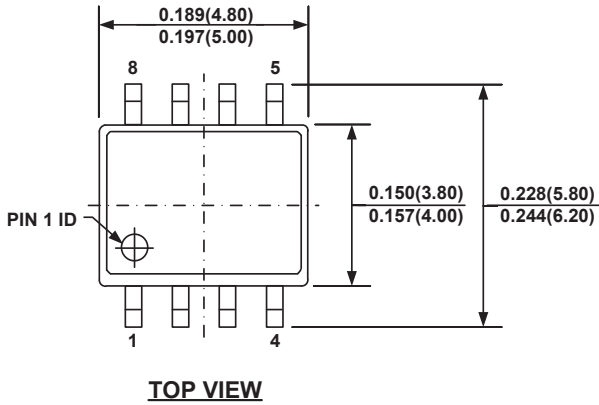

Figure 4: $V_{IN} = 8 \sim 95V$, $V_{OUT} = 5V$, $I_{OUT} = 1A$

PACKAGE INFORMATION
SOIC-8 EP

NOTE:

- 1) CONTROL DIMENSION IS IN INCHES. DIMENSION IN BRACKET IS IN MILLIMETERS.
- 2) PACKAGE LENGTH DOES NOT INCLUDE MOLD FLASH, PROTRUSIONS OR GATE BURRS.
- 3) PACKAGE WIDTH DOES NOT INCLUDE INTERLEAD FLASH OR PROTRUSIONS.
- 4) LEAD COPLANARITY (BOTTOM OF LEADS AFTER FORMING) SHALL BE 0.004" INCHES MAX.
- 5) DRAWING CONFORMS TO JEDEC MS-012, VARIATION BA.
- 6) DRAWING IS NOT TO SCALE.

NOTICE: The information in this document is subject to change without notice. Users should warrant and guarantee that third party Intellectual Property rights are not infringed upon when integrating MPS products into any application. MPS will not assume any legal responsibility for any said applications.

Mouser Electronics

Authorized Distributor

Click to View Pricing, Inventory, Delivery & Lifecycle Information:

[Monolithic Power Systems \(MPS\):](#)

[MP9486AGN](#) [MP9486GN](#)