

2μA I_Q, 600mA Low-Dropout Linear Voltage Regulator

1 General Description

The RT9080 series is a low-dropout (LDO) linear voltage regulator featuring an enable function, operating over a wide input voltage range from 1.2V to 5.5V. The RT9080 delivers a maximum output current of 600mA and is designed for low-power operation, all within a compact package.

The features of low quiescent current, as low as 2μA, and almost zero disable current, are ideal for powering battery equipment for a longer service life. The RT9080 series is stable with the ceramic output capacitor over its wide input range from 1.2V to 5.5V and the entire range of output load current (0mA to 600mA). The recommended junction temperature range is -40°C to 125°C, and the ambient temperature range is -40°C to 85°C.

2 Ordering Information

RT9080-□□□□

- Pin 1 Orientation**
Empty: Quadrant 1 or Quadrant 3
(2): Quadrant 2, Follow EIA-481
(ZQFN-4L 1x1 Only)
- Package Type⁽¹⁾**
J5: TSOT-23-5
QZ: ZQFN-4L 1x1 (Z-Type)
- Lead Plating System**
G: Richtek Green Policy Compliant⁽²⁾
- Output Voltage**
08 : 0.8V
:
2H : 2.85V
:
33 : 3.3V
Special Request : Any voltage between
0.8V and 3.3V under specific business
agreement
- Pin Function**
RT9080: Without SNS Pin
RT9080N: With SNS Pin

Note 1.

- Marked with ⁽¹⁾ indicated: Compatible with the current requirements of IPC/JEDEC J-STD-020.
- Marked with ⁽²⁾ indicated: Richtek products are Richtek Green Policy compliant.

3 Features

- 2μA Quiescent Current at No Load
- PSRR = 75dB at 1kHz
- Adjustable Output Voltage Available for Specific Applications
- ±2% Output Accuracy
- 600mA (V_{IN} ≥ 2.3V) Output Current
- Low (0.1μA) Disable Current
- Operating Input Voltage: 1.2V to 5.5V
- Dropout Voltage: 0.31V at 600mA when V_{OUT} ≥ 3V
- Support Fixed Output Voltage: 0.8V to 3.3V
- Stable with Ceramic or Tantalum Capacitor
- Current-Limit Protection
- Over-Temperature Protection
- Available in TSOT-23-5 and ZQFN-4L 1x1 (ZDFN-4L 1x1) Packages

4 Applications

- Portable, Battery Powered Equipment
- Ultra Low Power Microcontrollers
- Notebook Computers

5 Marking Information

For marking information, contact our sales representative directly or through a Richtek distributor located in your area.

6 Simplified Application Circuit

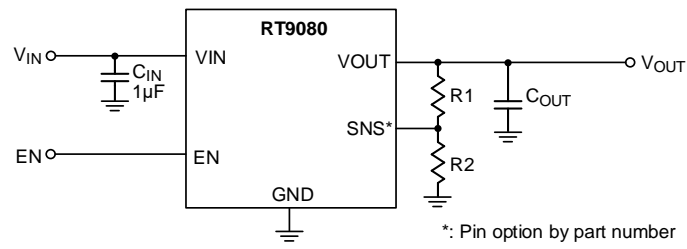
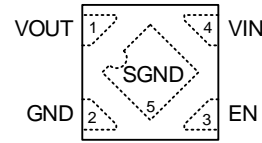
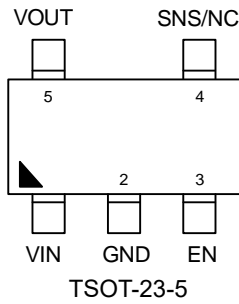

Table of Contents

1	General Description -----	1	18	Application Information -----	13
2	Ordering Information -----	1	18.1	Enable-----	13
3	Features -----	1	18.2	Adjustable Output Voltage Setting-----	13
4	Applications -----	1	18.3	Current Limit-----	14
5	Marking Information -----	1	18.4	Thermal Considerations-----	14
6	Simplified Application Circuit -----	2	18.5	Layout Considerations-----	15
7	Pin Configuration -----	4	19	Outline Dimension -----	17
8	Functional Pin Description -----	4	19.1	TSOT-23-5-----	17
9	Functional Block Diagram -----	4	19.2	ZQFN-4L 1x1 Package-----	18
10	Absolute Maximum Ratings -----	5	20	Footprint Information -----	19
11	ESD Ratings -----	5	20.1	TSOT-23-5 Package-----	19
12	Recommended Operating Conditions -----	5	20.2	ZQFN-4L 1x1 Package-----	20
13	Thermal Information -----	5	21	Packing Information -----	21
14	Electrical Characteristics -----	6	21.1	Tape and Reel Data-----	21
15	Typical Application Circuit -----	7	21.2	Tape and Reel Packing-----	24
16	Typical Operating Characteristics -----	8	21.3	Packing Material Anti-ESD Property-----	27
17	Operation -----	12	22	Datasheet Revision History -----	28
17.1	Basic Operation-----	12			
17.2	Pass Transistor-----	12			
17.3	Error Amplifier-----	12			
17.4	Chip Enable and Shutdown-----	12			
17.5	Current-Limit Protection-----	12			
17.6	Over-Temperature Protection-----	12			
17.7	Output Active Discharge-----	12			

7 Pin Configuration

(TOP VIEW)



ZQFN-4L 1x1 (ZDFN-4L 1x1)

8 Functional Pin Description

Pin No.		Pin Name	Pin Function
TSOT-23-5	ZQFN-4L 1x1 (ZDFN-4L 1x1)		
1	4	VIN	Supply input. A general 1μF ceramic capacitor should be placed as close as possible to this pin for better noise rejection.
2	2	GND	Ground. The exposed pad must be soldered to a large PCB and connected to GND for maximum power dissipation.
3	3	1EN	Enable control input. Connect this pin to logic-high to enable the regulator. Pull this pin below 0.4V to turn the regulator off, reducing the quiescent current to a fraction of its operating value.
4	--	SNS	Output voltage sense pin for RT9080N only. This pin is used to set the desired output voltage via an external resistive divider. The SNS pin voltage is 0.8V typically.
		NC	No internal connection. Leaving this pin floating does not affect the functionality of the device. By connecting this pin to GND, design engineers can extend the GND copper coverage on the PCB top layer to enhance the thermal convection.
5	1	VOUT	LDO output pin. A 1μF or larger ceramic capacitor (0.7μF or greater effective capacitance) is required for stability. Place the output capacitor as close to the device as possible and minimize the impedance between the VOUT pin and load.
--	5 (Exposed Pad)	SGND	Substrate of the IC. Connect to the GND plane for maximum thermal dissipation.

9 Functional Block Diagram

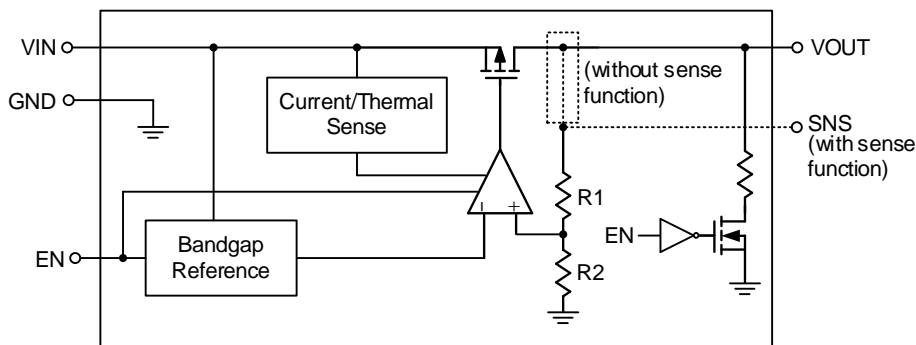

10 Absolute Maximum Ratings

(Note 2)

- VIN, VOUT, SNS, EN to GND ----- -0.3V to 6.5V
- VOUT to VIN ----- -6.5V to 0.3V
- Lead Temperature (Soldering, 10 sec.) ----- 260°C
- Junction Temperature ----- 150°C
- Storage Temperature Range ----- -65°C to 150°C

Note 2. Stresses beyond those listed under “Absolute Maximum Ratings” may cause permanent damage to the device. These are stress ratings only, and functional operation of the device at these or any other conditions beyond those indicated in the operational sections of the specifications is not implied. Exposure to absolute maximum rating conditions may affect device reliability.

11 ESD Ratings

(Note 3)

- ESD Susceptibility
HBM (Human Body Model)----- 2kV

Note 3. Devices are ESD sensitive. Handling precautions are recommended.

12 Recommended Operating Conditions

(Note 4)

- Input Voltage, VIN ----- 1.2V to 5.5V
- Junction Temperature Range----- -40°C to 125°C
- Ambient Temperature Range----- -40°C to 85°C

Note 4. The device is not guaranteed to function outside its operating conditions.

13 Thermal Information

(Note 5 and Note 6)

Thermal Parameter		TSOT-23-5	ZQFN-4L 1x1 (ZDFN-4L 1x1)	Unit
θ_{JA}	Junction-to-ambient thermal resistance (JEDEC standard)	189.4	291.4	°C/W
$\theta_{JC(Top)}$	Junction-to-case (top) thermal resistance	75.9	163	°C/W
$\theta_{JC(Bottom)}$	Junction-to-case (bottom) thermal resistance	55.8	90.7	°C/W
$\theta_{JA(EVB)}$	Junction-to-ambient thermal resistance (specific EVB)	100.7	236	°C/W
$\Psi_{JC(Top)}$	Junction-to-top characterization parameter	21.6	52.3	°C/W
Ψ_{JB}	Junction-to-board characterization parameter	67.2	189.1	°C/W

Note 5. For more information about thermal parameter, see the Application and Definition of Thermal Resistances report, [AN061](#).

Note 6. $\theta_{JA(EVB)}$, $\Psi_{JC(Top)}$, and Ψ_{JB} are measured on a high effective-thermal-conductivity four-layer test board which is in size of 70mm x 50mm; furthermore, all layers with 1 oz. Cu. Thermal resistance/parameter values may vary depending on the PCB material, layout, and test environmental conditions.

14 Electrical Characteristics

($V_{VOUT} + 1 < V_{IN} < 5.5V$, $T_A = 25^{\circ}C$, unless otherwise specified.)

Parameter	Symbol	Test Conditions	Min	Typ	Max	Unit	
Output Voltage	V_{VOUT}		0.8	--	3.3	V	
Output Voltage Accuracy	V_{VOUT_ACC}	$I_{LOAD} = 1mA$	-2	--	2	%	
SNS Reference Voltage (for RT9080N-08GJ5 only)	V_{REF}	$I_{LOAD} = 1mA$	--	0.8	--	V	
Dropout Voltage ($I_{LOAD} = 600mA$) (Note 7)	V_{DROP}	$0.8V \leq V_{VOUT} < 1.05V$ (TSOT-23-5)	--	1.05	1.33	V	
		$0.8V \leq V_{VOUT} < 1.05V$ (ZQFN-4L 1x1)	--	1.05	1.63		
		$1.05V \leq V_{VOUT} < 1.2V$	--	0.8	1.13		
		$1.2V \leq V_{VOUT} < 1.5V$	--	0.71	1.03		
		$1.5V \leq V_{VOUT} < 1.8V$	--	0.57	0.93		
		$1.8V \leq V_{VOUT} < 2.1V$	--	0.57	0.83		
		$2.1V \leq V_{VOUT} < 2.5V$	--	0.41	0.73		
		$2.5V \leq V_{VOUT} < 3V$	--	0.36	0.63		
		$3V \leq V_{VOUT}$	--	0.31	0.53		
Quiescent Current	I_Q	$I_{LOAD} = 0mA$, $V_{VOUT} \leq 5.5V$ $V_{VIN} \geq V_{VOUT} + V_{DROP}$	--	2	4	μA	
Shutdown GND Current (Note 8)	I_{SHDN}	$V_{EN} = 0V$	--	0.1	0.5	μA	
		$V_{EN} = 0V$, $V_{VOUT} = 0V$	--	0.1	0.5	μA	
EN Input Current	I_{EN}	$V_{EN} = 5.5V$	--	--	0.1	μA	
Line Regulation	V_{LINE_REG}	$I_{LOAD} = 1mA$	$1.2V \leq V_{VIN} < 1.5V$	--	0.3	0.6	%
			$1.5V \leq V_{VIN} < 1.8V$	--	0.15	0.3	
			$1.8V \leq V_{VIN} < 5.5V$	--	0.13	0.35	
Load Regulation	V_{LOAD_REG}	$1mA < I_{LOAD} < 600mA$	--	0.5	1	%	
Power Supply Rejection Ratio	$PSRR$	$V_{VIN} = 3V$, $I_{LOAD} = 50mA$, $C_{OUT} = 1\mu F$, $V_{VOUT} = 2.5V$, $f = 1kHz$	--	75	--	dB	
Output Voltage Noise	V_n	$C_{OUT} = 1\mu F$, $I_{LOAD} = 150mA$, $BW = 10Hz$ to $100kHz$, $V_{VIN} = V_{VOUT} + 1V$	$V_{VOUT} = 0.8V$	--	26	--	$\mu VRMS$
			$V_{VOUT} = 1.2V$	--	37	--	
			$V_{VOUT} = 1.8V$	--	39	--	
			$V_{VOUT} = 3.3V$	--	42	--	
Current Limit	I_{LIM}	$V_{VOUT} = 90\%V_{OUT(Normal)}$	610	1100	--	mA	
EN Input Voltage Rising Threshold	V_{EN_R}	$V_{VIN} = 5V$	0.9	--	--	V	
EN Input Voltage Falling Threshold	V_{EN_F}	$V_{VIN} = 5V$	--	--	0.4		
Over-Temperature Protection Threshold	T_{OTP}	$I_{LOAD} = 30mA$, $V_{VIN} \geq 1.5V$	--	150	--	$^{\circ}C$	
Over-Temperature Protection Hysteresis	T_{OTP_HYS}		--	20	--	$^{\circ}C$	
Discharge Resistor	R_{DISCHG}	$V_{EN} = 0V$, $V_{VOUT} = 0.1V$	--	80	--	Ω	

Note 7. The dropout voltage is defined as $V_{VIN} - V_{VOUT}$ when V_{VOUT} is 98% of the normal value of V_{VOUT} .

Note 8. The specification is tested at wafer stage and guaranteed by design after assembly.

15 Typical Application Circuit

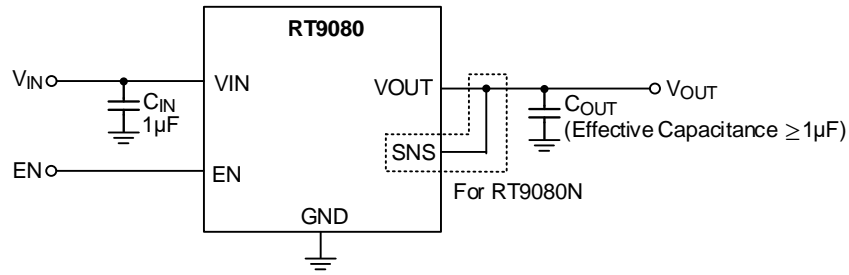

Figure 1. Application with Sense Function (RT9080) / without Sense Function (RT9080N)

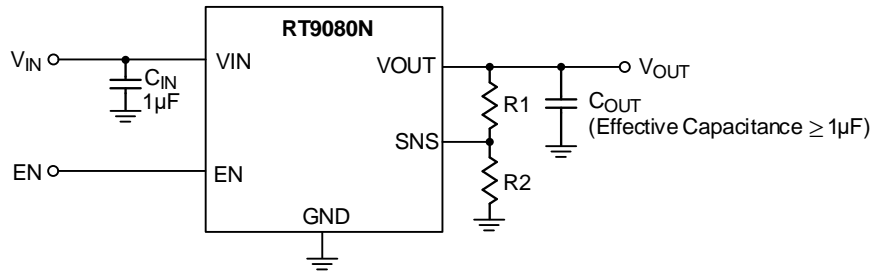
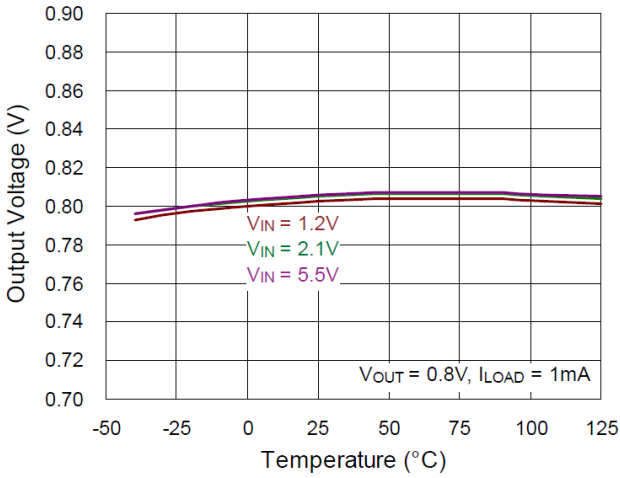

Figure 2. Adjustable Output Voltage Application Circuit

16 Typical Operating Characteristics

Output Voltage vs. Temperature



Output Voltage vs. Temperature

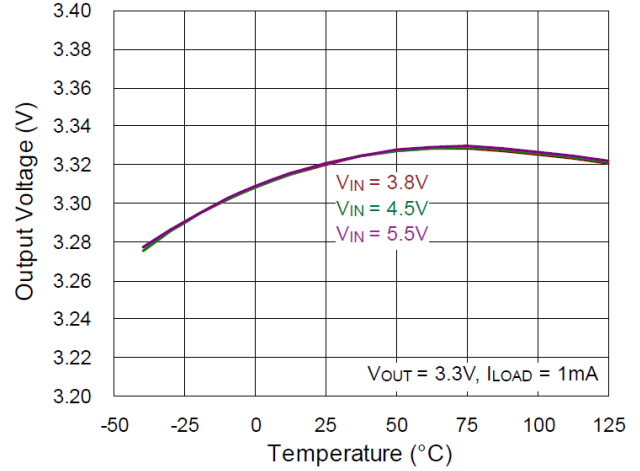

Output Voltage vs. Input Voltage

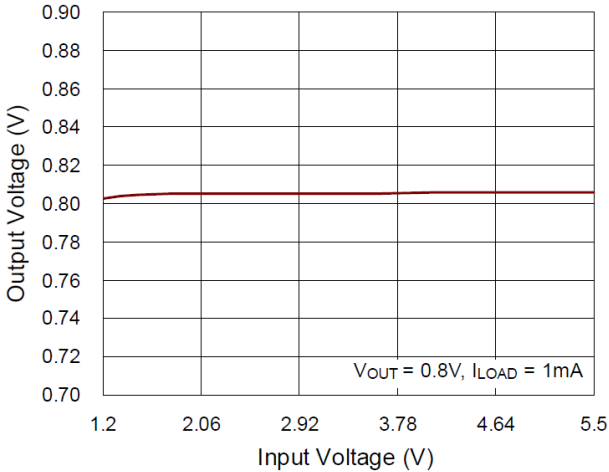

Output Voltage vs. Load Current

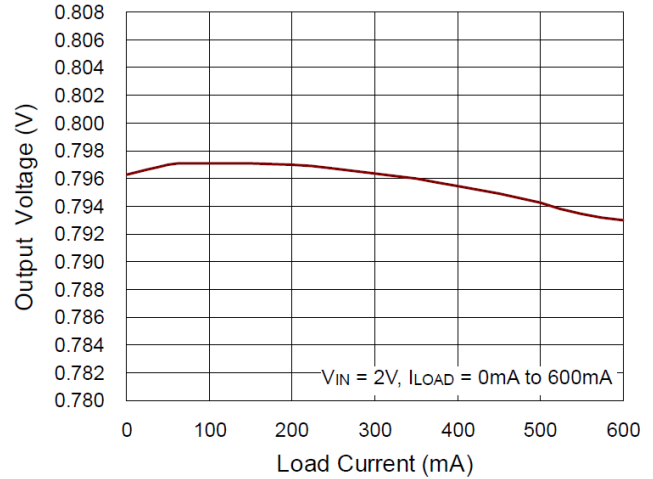

Ground Current vs. Load Current

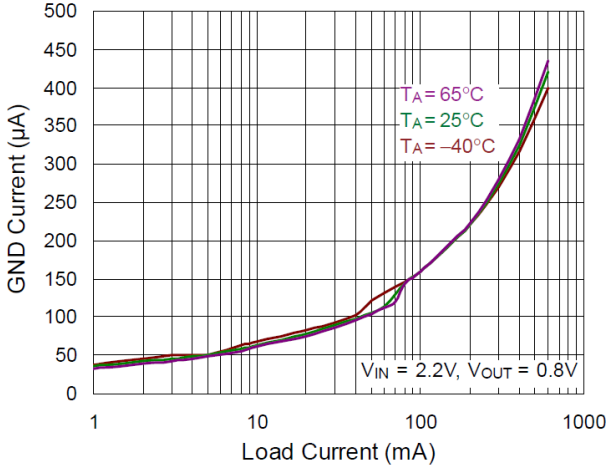

Ground Current vs. Load Current

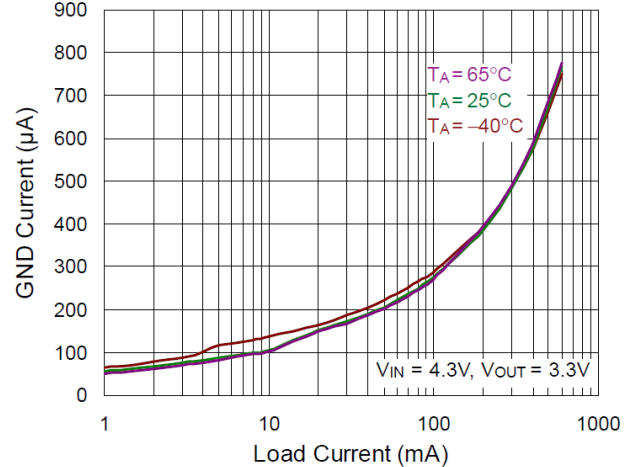

Shutdown Current vs. Input Voltage

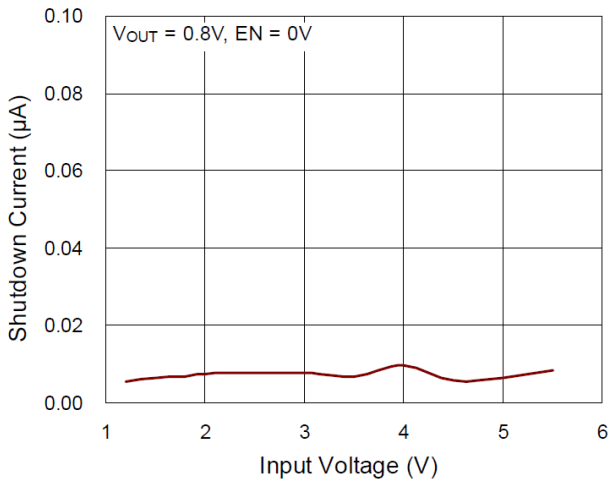

Shutdown Leakage Current vs. Temperature

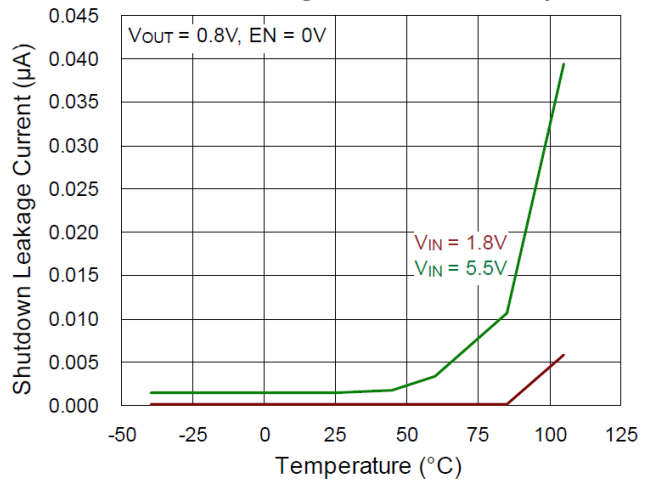

Enable Threshold vs. Input Voltage

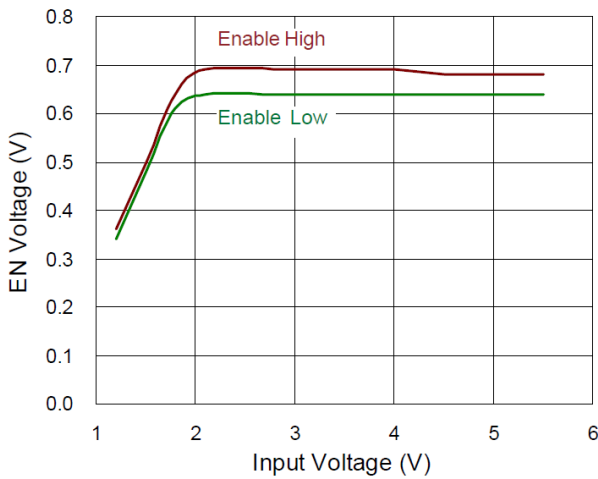

Enable Threshold vs. Temperature

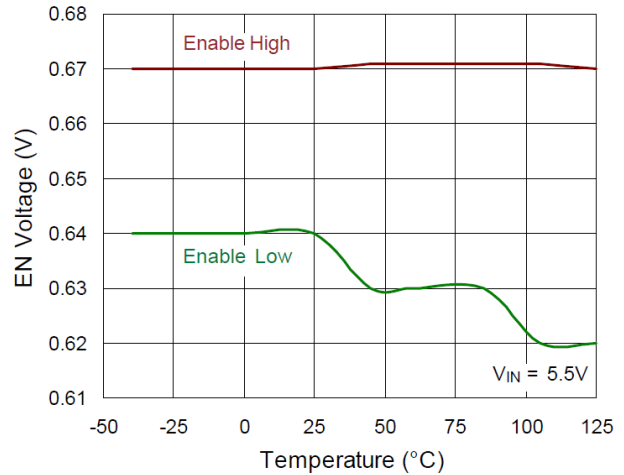

Dropout Voltage vs. Temperature

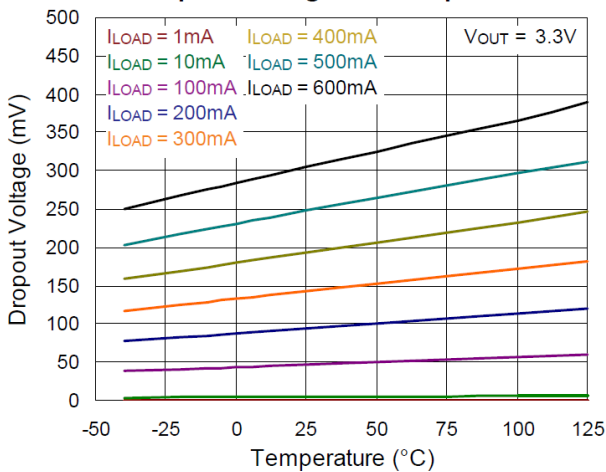

Current Limit vs. Temperature

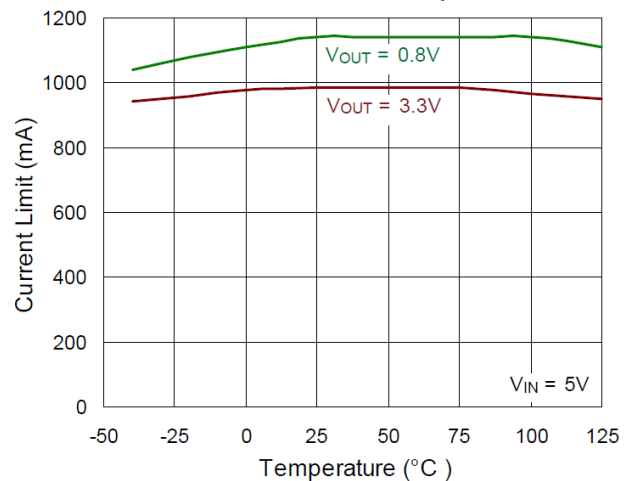

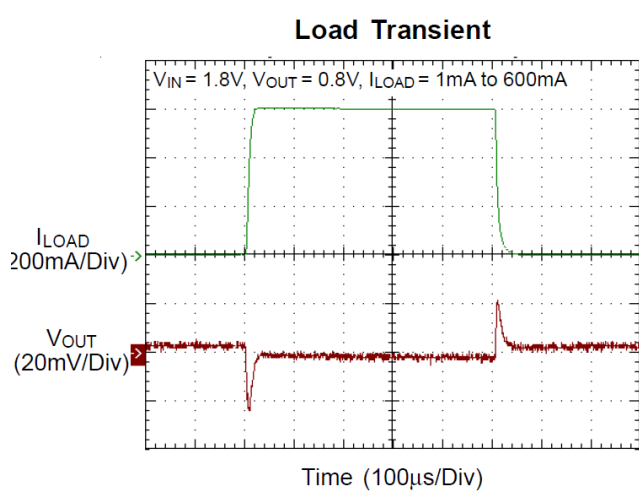
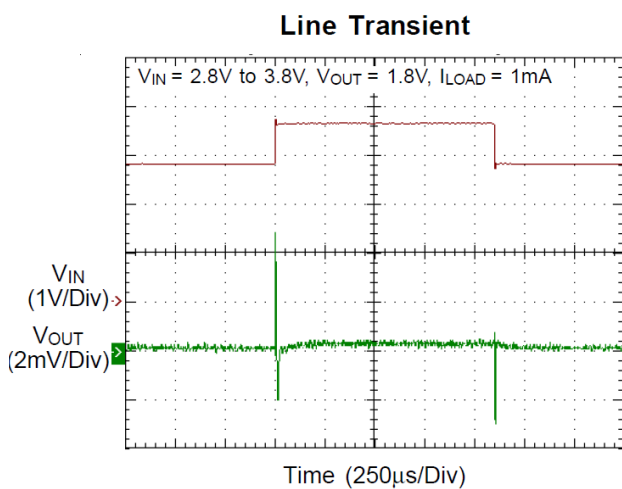
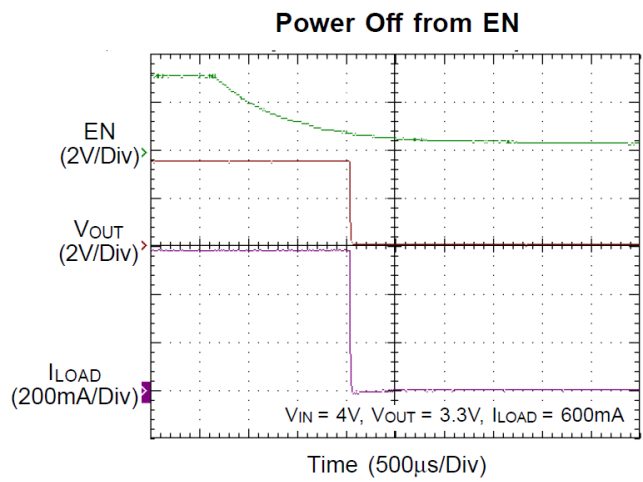
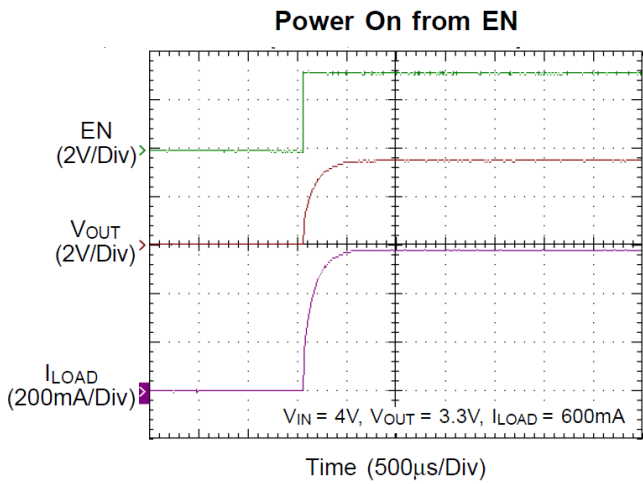
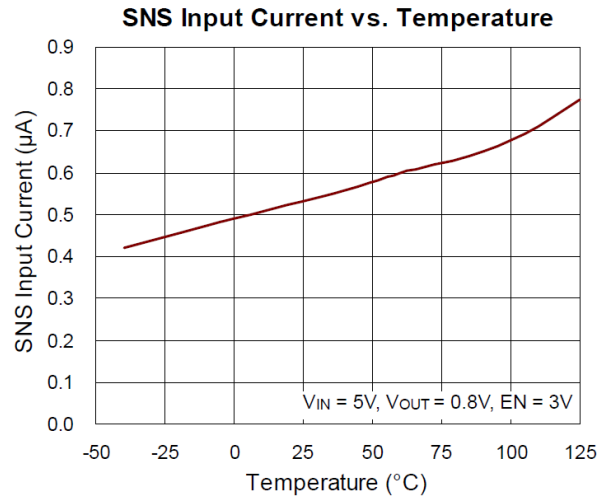
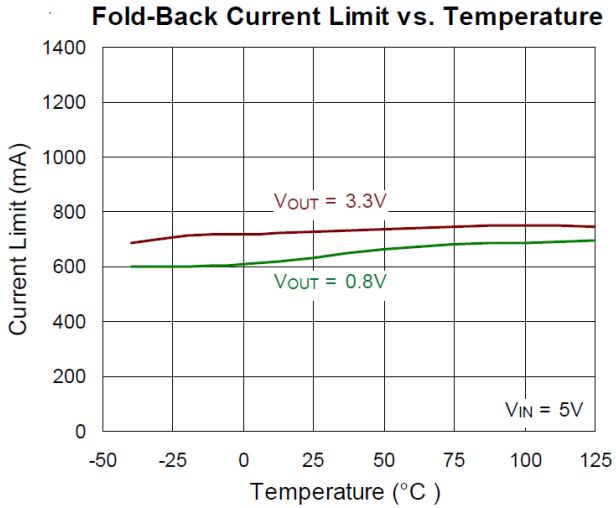

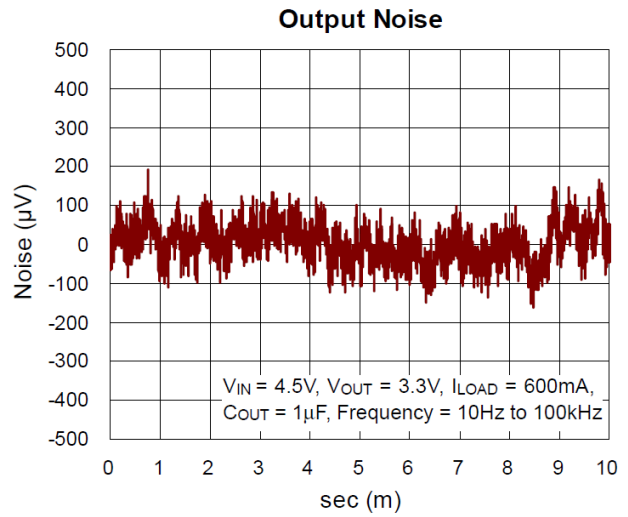
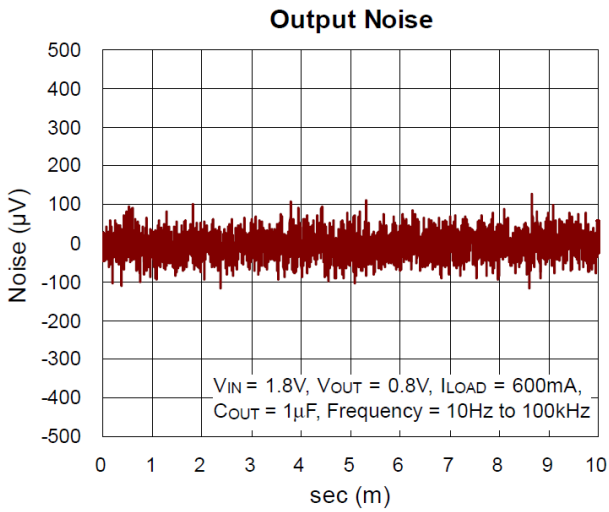
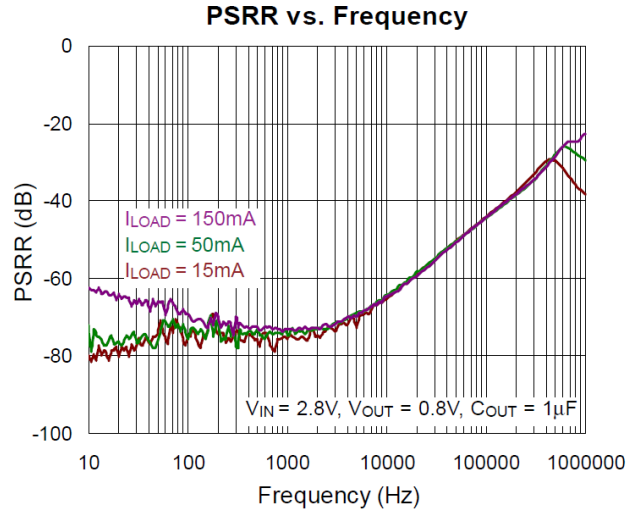
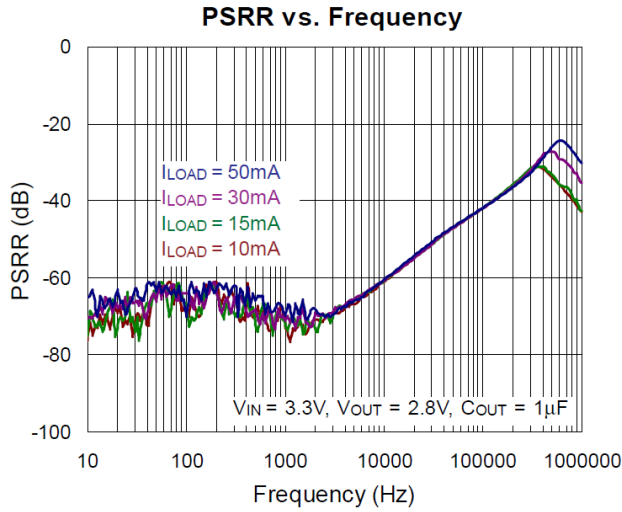

17 Operation

17.1 Basic Operation

The RT9080 series is a low quiescent current linear voltage regulator designed especially for systems with few external components. The input voltage range is from 1.2V to 5.5V. The minimum output capacitance required for stable operation is 1 μ F, considering the temperature and voltage coefficient of the capacitor.

17.2 Pass Transistor

The RT9080 series builds in a P-MOSFET output transistor, which provides low switch-on resistance for low dropout voltage applications.

17.3 Error Amplifier

The Error Amplifier compares the internal reference voltage with the output feedback voltage from the internal divider, and controls the Gate voltage of the P-MOSFET to support good line regulation and load regulation at the output voltage.

17.4 Chip Enable and Shutdown

The RT9080 series provides an EN pin, which serves as an external chip enable control, to enable or disable the device. A V_{EN} below 0.4V turns the regulator off and enters shutdown mode, while a V_{EN} above 0.9V turns the regulator on. When the regulator is in shutdown mode, the ground current is reduced to a maximum of 0.5 μ A.

17.5 Current-Limit Protection

The RT9080 series provides a current-limit function to prevent the device from being damaged during overload or short-circuit conditions. This current is detected by an internal sensing transistor.

17.6 Over-Temperature Protection

The over-temperature protection function will turn off the P-MOSFET when the junction temperature exceeds 150°C (typical), and the output current exceeds 30mA. Once the junction temperature cools down by approximately 20°C, the regulator will automatically resume operation.

17.7 Output Active Discharge

When the RT9080 series is operating in shutdown mode, the device has an internal active pull-down circuit that connects the output to GND through a resistor for discharging purpose.

18 Application Information

(Note 9)

Like any low dropout linear voltage regulator, the RT9080's external input and output capacitors must be properly selected for stability and performance. Use a 1μF or larger input capacitor and place it close to the IC's VIN and GND pins. Any output capacitor meeting the minimum 1mΩ ESR (Equivalent Series Resistance) requirement and having a capacitance larger than 1μF may be used. Place the output capacitor close to the IC's VOUT and GND pins. Increasing capacitance and decreasing ESR can improve the circuit's PSRR and line transient response.

18.1 Enable

The RT9080 series has an EN pin to turn on or turn off the regulator. When the EN pin is in logic-high, the regulator will be turned on. The shutdown current is almost 0μA typical. The EN pin may be directly tied to VIN to keep the part on. The Enable input is CMOS logic and should not be left floating.

18.2 Adjustable Output Voltage Setting

Because of the small input current at the SNS pin, the RT9080N with the SNS pin can also work as an adjustable output voltage LDO. Figure 2 gives the connections for the adjustable output voltage application. The resistor divider from VOUT to SNS sets the output voltage when in regulation.

The voltage on the SNS pin sets the output voltage and is determined by the values of R1 and R2. To maintain a good temperature coefficient of the output voltage, the values of R1 and R2 should be selected with consideration for the temperature coefficient of the input current at the SNS pin. A current greater than 50μA in the resistor divider is recommended to meet the above requirement. The adjustable output voltage can be calculated using the formula provided in Equation 1:

$$V_{OUT} = \frac{R1 + R2}{R2} \times V_{SNS} \tag{1}$$

where VSNS is determined by the output voltage options listed in the ordering information for the RT9080N. The maximum adjustable output voltage can be as high as the input voltage minus the dropout voltage.

When we choose 51kΩ and 16kΩ as R1 and R2, respectively, and select a 0.8V output at the SNS pin, the adjustable output voltage will be approximately 3.35V. The temperature coefficient, as shown in Figure 4, remains excellent for this type of application.

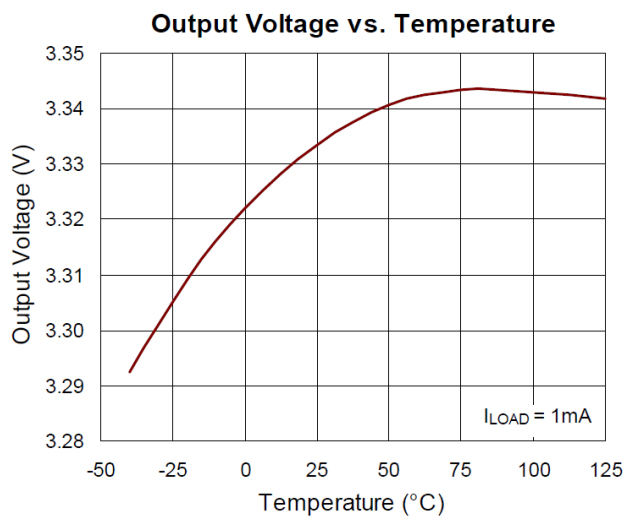

Figure 3. Temperature Coefficient of Adjustable Output Voltage

The minimum recommended current of 50µA in the resistor divider makes the application no longer an ultra-low quiescent LDO. [Figure 4](#) presents another fine adjustable output voltage application that allow the LDO to continue operating with low power consumption. The fine-tuning range is recommended to be less than 50mV ($R1 \leq 91k\Omega$) to maintain a good temperature coefficient of the output voltage.

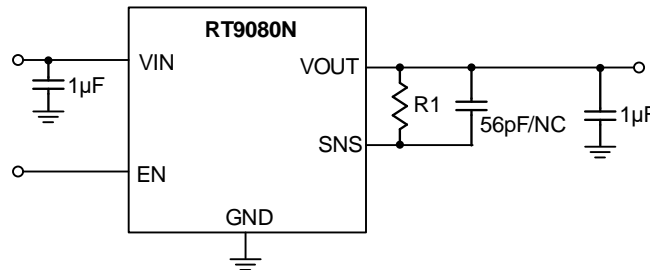

Figure 4. Fine Adjustable Output Voltage Application Circuit

There is no additional current consumption in the above application. However, the temperature coefficient of the output voltage will be degraded by the input current at the SNS pin. If the tuning range is larger than 50mV, a compensation capacitor (56pF) is required to maintain the stability of the output voltage. The fine adjustable output voltage can be calculated using the formula provided in Equation 2:

$$V_{OUT} = V_{SNS} + I_{SNS} \times R1 \quad (2)$$

where I_{SNS} is the input current at the SNS pin (typically 550nA at room temperature) and V_{SNS} is determined by the output voltage options listed in the ordering information for the RT9080N.

18.3 Current Limit

The RT9080 series features an independent current limiter that monitors and controls the gate voltage of the pass transistor, limiting the output current to 1.1A (typical). When the output voltage decreases further, the current limiting level is reduced to around 0.6A, which is named fold-back current limit. This allows the output to be shorted to ground indefinitely without damaging the device.

18.4 Thermal Considerations

For continuous operation, do not exceed absolute maximum junction temperature. The maximum power dissipation depends on the thermal resistance of the IC package, PCB layout, rate of surrounding airflow, and difference between junction and ambient temperature. The maximum power dissipation can be calculated by the following formula:

$$P_{D(MAX)} = (T_{J(MAX)} - T_A) / \theta_{JA}$$

where $T_{J(MAX)}$ is the maximum junction temperature, T_A is the ambient temperature, and θ_{JA} is the junction to ambient thermal resistance.

For recommended operating condition specifications, the maximum junction temperature is 125°C and T_A is the ambient temperature. The junction to ambient thermal resistance, $\theta_{JA(EVB)}$, is highly package dependent. For TSOT-23-5 package, the thermal resistance, $\theta_{JA(EVB)}$, is 100.7°C/W on a standard JEDEC 51-7 four-layer thermal test board. For ZQFN-4L 1x1 (ZDFN-4L 1x1) package, the thermal resistance, $\theta_{JA(EVB)}$, is 236°C/W on a two-layer Richtek evaluation board. The maximum power dissipation at $T_A = 25^\circ\text{C}$ can be calculated by the following formula:

$$P_{D(MAX)} = (125^\circ\text{C} - 25^\circ\text{C}) / (100.7^\circ\text{C/W}) = 0.99\text{W for TSOT-23-5 package}$$

$$P_{D(MAX)} = (125^\circ\text{C} - 25^\circ\text{C}) / (236^\circ\text{C/W}) = 0.42\text{W for ZQFN-4L 1x1 (ZDFN-4L 1x1) package}$$

The maximum power dissipation depends on the operating ambient temperature for fixed $T_{J(MAX)}$ and thermal resistance, $\theta_{JA(EVB)}$. The derating curves in [Figure 5](#) allow the designer to see the effect of rising ambient temperature on the maximum power dissipation.

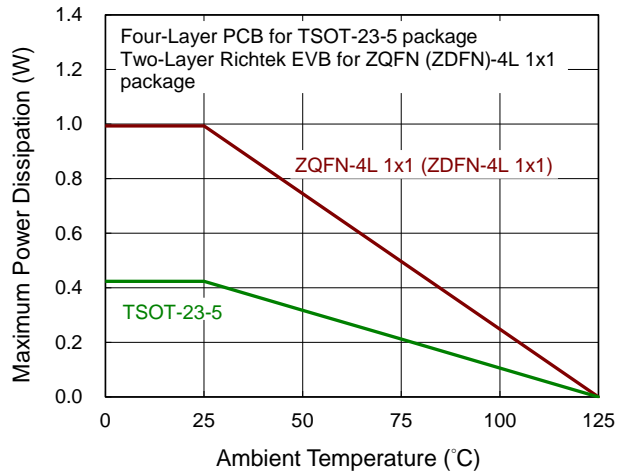

Figure 5. Derating Curves of Maximum Power Dissipation

18.5 Layout Considerations

For best performance of the RT9080 series, the PCB layout suggestions below are highly recommended:

- Input capacitor must be placed as close as possible to the IC to minimize the power loop area.
- Minimize the power trace length and avoid using vias for the input and output capacitors connections.

[Figure 6](#) and [Figure 7](#) show the layout examples that help minimize inductive parasitic components, reduce load transients, and ensure good circuit stability.

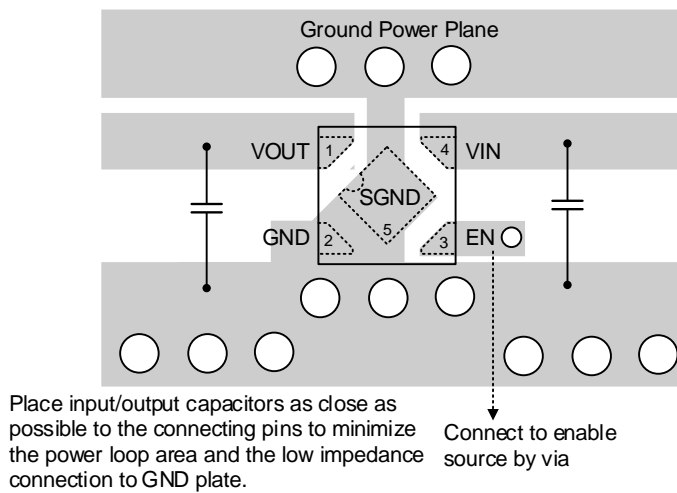

Figure 6. PCB Layout Guide for ZQFN-4L 1x1 Package

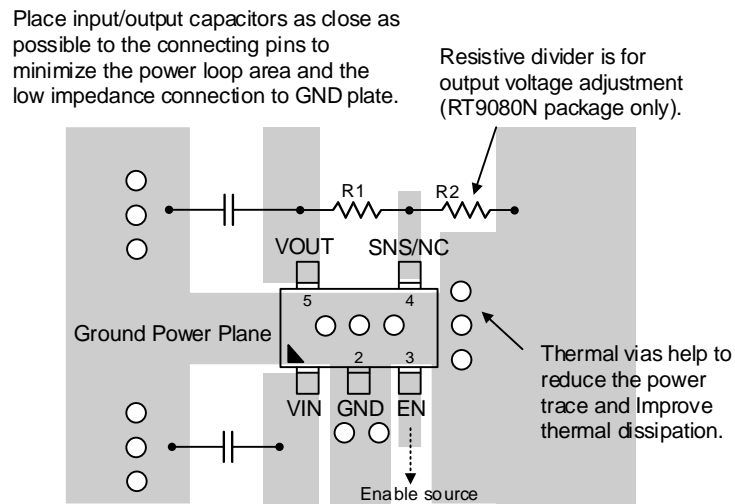
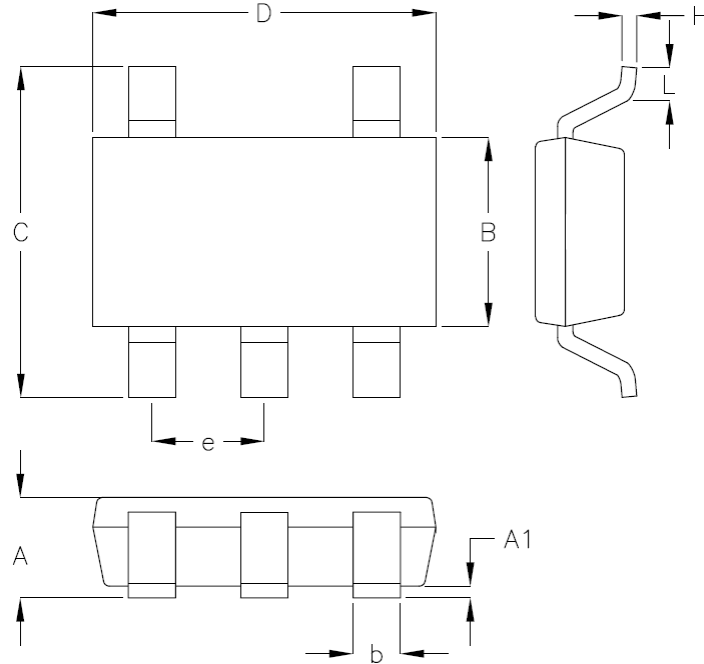

Figure 7. PCB Layout Guide for TSOT-23-5 Package

Note 9. The information provided in this section is for reference only. The customer is solely responsible for the designing, validating, and testing your product incorporating Richtek’s product and ensure such product meets applicable standards and any safety, security, or other requirements.

19 Outline Dimension

19.1 TSOT-23-5



Symbol	Dimensions In Millimeters		Dimensions In Inches	
	Min	Max	Min	Max
A	0.700	1.000	0.028	0.039
A1	0.000	0.100	0.000	0.004
B	1.397	1.803	0.055	0.071
b	0.300	0.559	0.012	0.022
C	2.591	3.000	0.102	0.118
D	2.692	3.099	0.106	0.122
e	0.838	1.041	0.033	0.041
H	0.080	0.254	0.003	0.010
L	0.300	0.610	0.012	0.024

TSOT-23-5 Surface Mount Package

19.2 ZQFN-4L 1x1 Package

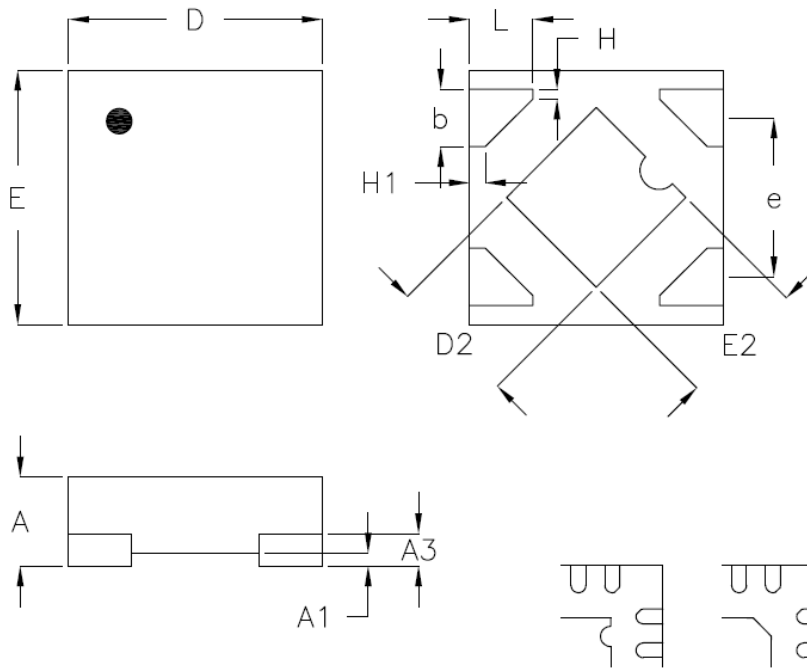

DETAILA
Pin #1 ID and Tie Bar Mark Options

Note : The configuration of the Pin #1 identifier is optional, but must be located within the zone indicated.

Symbol	Dimensions In Millimeters		Dimensions In Inches	
	Min	Max	Min	Max
A	0.300	0.400	0.012	0.016
A1	0.000	0.050	0.000	0.002
A3	0.117	0.162	0.005	0.006
b	0.175	0.275	0.007	0.011
D	0.900	1.100	0.035	0.043
D2	0.450	0.550	0.018	0.022
E	0.900	1.100	0.035	0.043
E2	0.450	0.550	0.018	0.022
e	0.625		0.025	
L	0.200	0.300	0.008	0.012
H	0.039		0.002	
H1	0.064		0.003	

Z-Type 4L QFN 1x1 Package

20 Footprint Information

20.1 TSOT-23-5 Package

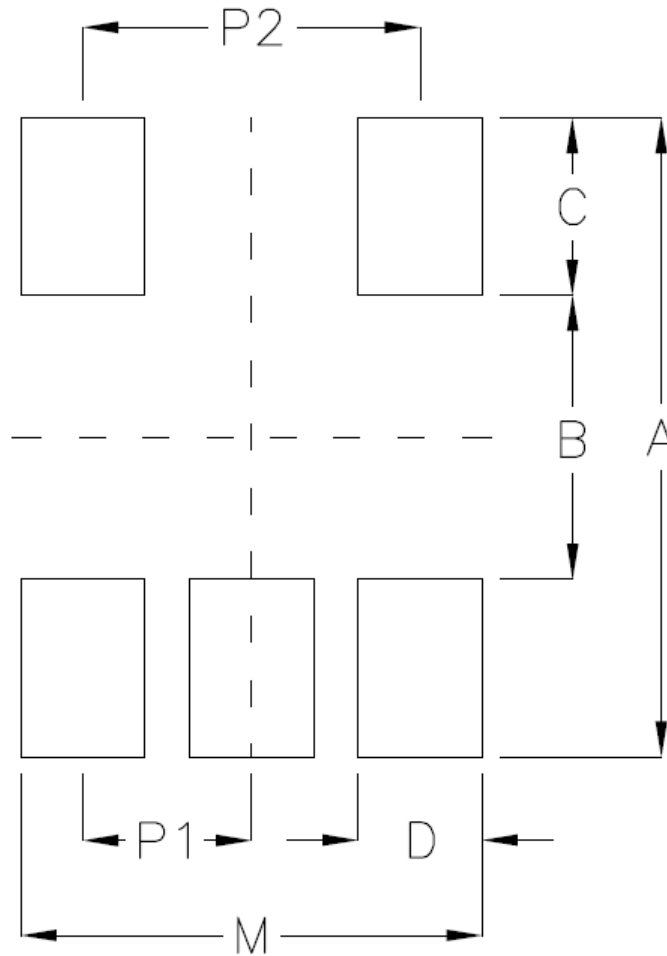

Package	Number of Pin	Footprint Dimension (mm)							Tolerance
		P1	P2	A	B	C	D	M	
TSOT-25/TSOT-25(FC)/SOT-25	5	0.95	1.90	3.60	1.60	1.00	0.70	2.60	±0.10

20.2 ZQFN-4L 1x1 Package

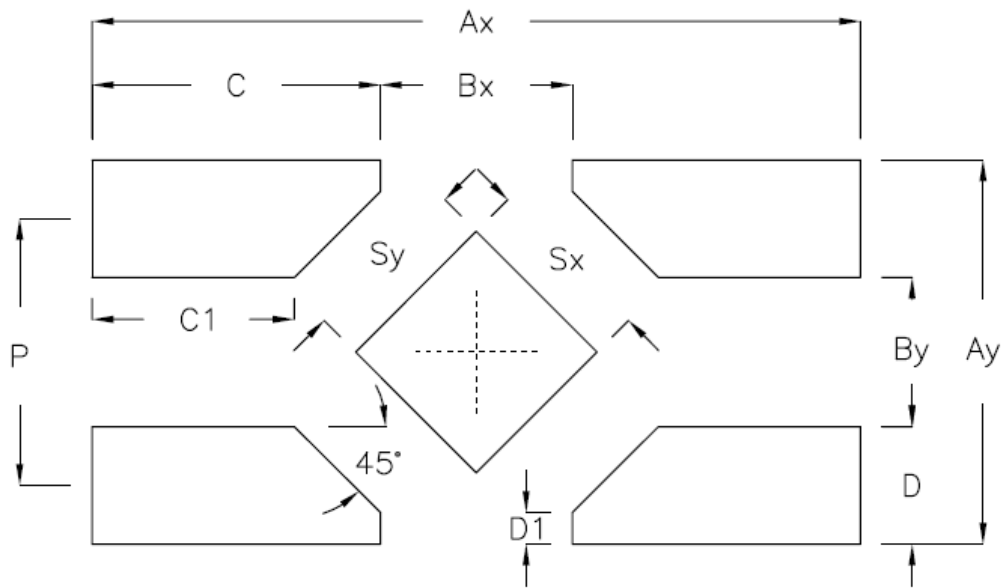

Package	Number of Pin	Footprint Dimension (mm)											Tolerance
		P	Ax	Ay	Bx	By	C	C1	D	D1	Sx	Sy	
U/X/ZQFN1x1-4	4	0.625	1.800	0.900	0.450	0.350	0.675	0.474	0.275	0.074	0.400	0.400	±0.050

21 Packing Information

21.1 Tape and Reel Data

21.1.1 TSOT-23-5

SOT/TSOT-23-5

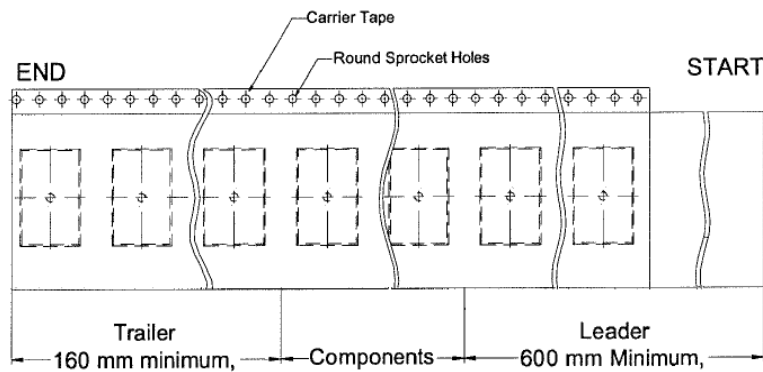
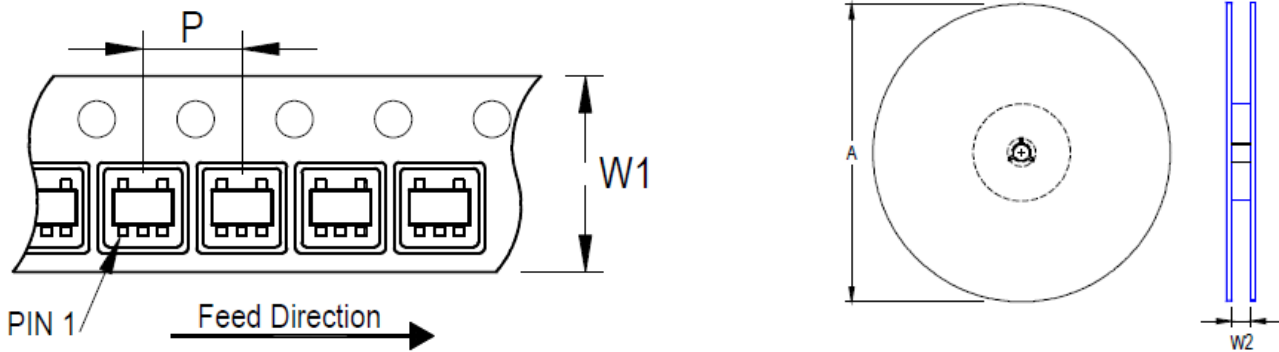

Package Type	Tape Size (W1) (mm)	Pocket Pitch (P) (mm)	Reel Size (A)		Units per Reel	Trailer (mm)	Leader (mm)	Reel Width (W2) Min/Max (mm)
			(mm)	(in)				
TSOT-23-5	8	4	180	7	3,000	160	600	8.4/9.9

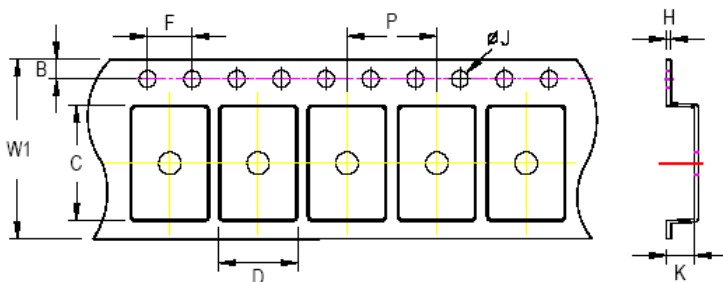

C, D, and K are determined by component size. The clearance between the components and the cavity is as follows:
- For 8mm carrier tape: 0.5mm max.

Tape Size	W1		P		B		F		ØJ		K		H
	Max	Min	Max	Min	Max	Min	Max	Min	Max	Min	Max	Max	
8mm	8.3mm	3.9mm	4.1mm	1.65mm	1.85mm	3.9mm	4.1mm	1.5mm	1.6mm	1.0mm	1.2mm	0.6mm	

21.1.2 ZQFN-4L 1x1

21.1.2.1 Quadrant 1

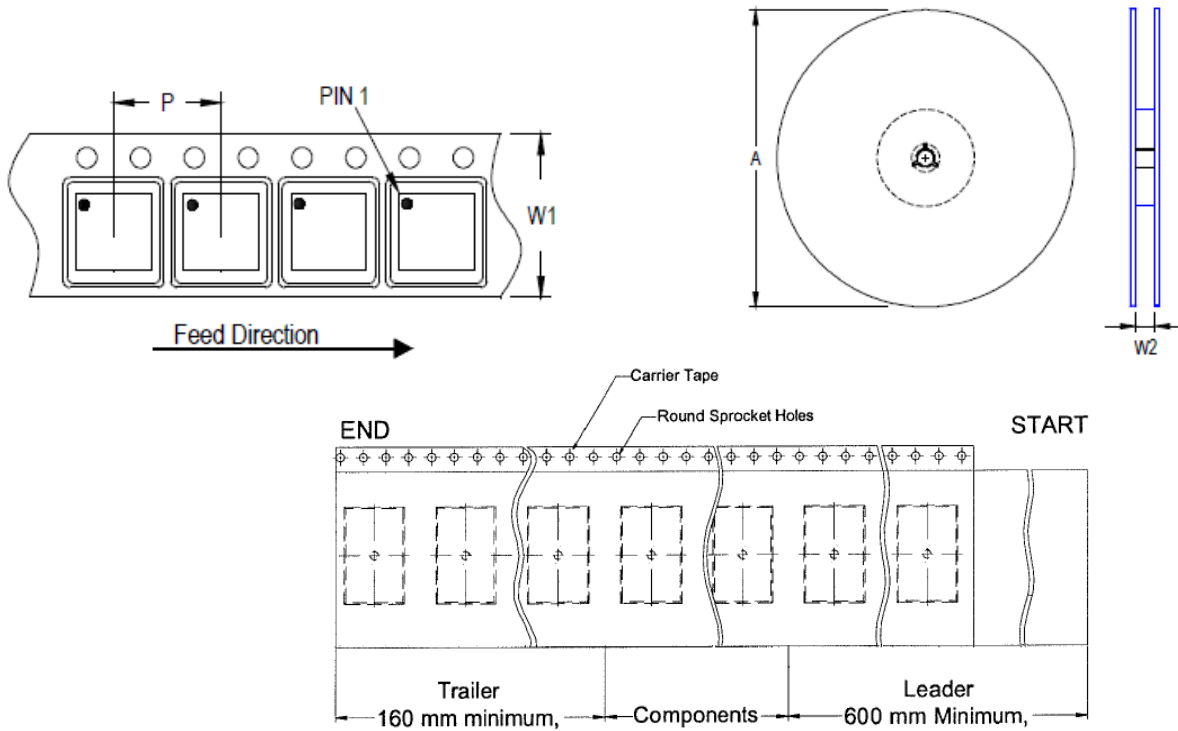

Package Type	Tape Size (W1) (mm)	Pocket Pitch (P) (mm)	Reel Size (A)		Units per Reel	Trailer (mm)	Leader (mm)	Reel Width (W2) Min/Max (mm)
			(mm)	(in)				
(Z) QFN/DFN 1x1	8	4	180	7	2,500	160	600	8.4/9.9

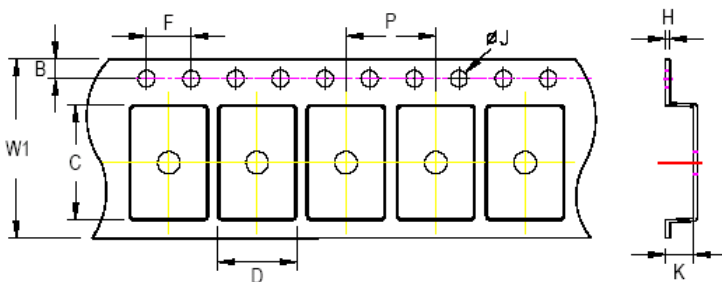

C, D, and K are determined by component size. The clearance between the components and the cavity is as follows:
 - For 8mm carrier tape: 0.5mm max.

Tape Size	W1		P		B		F		ØJ		K		H
	Max	Min	Max	Min	Max	Min	Max	Min	Max	Min	Max	Max	
8mm	8.3mm	3.9mm	4.1mm	1.65mm	1.85mm	3.9mm	4.1mm	1.5mm	1.6mm	0.5mm	0.6mm	0.6mm	

21.1.2.2 Quadrant 2

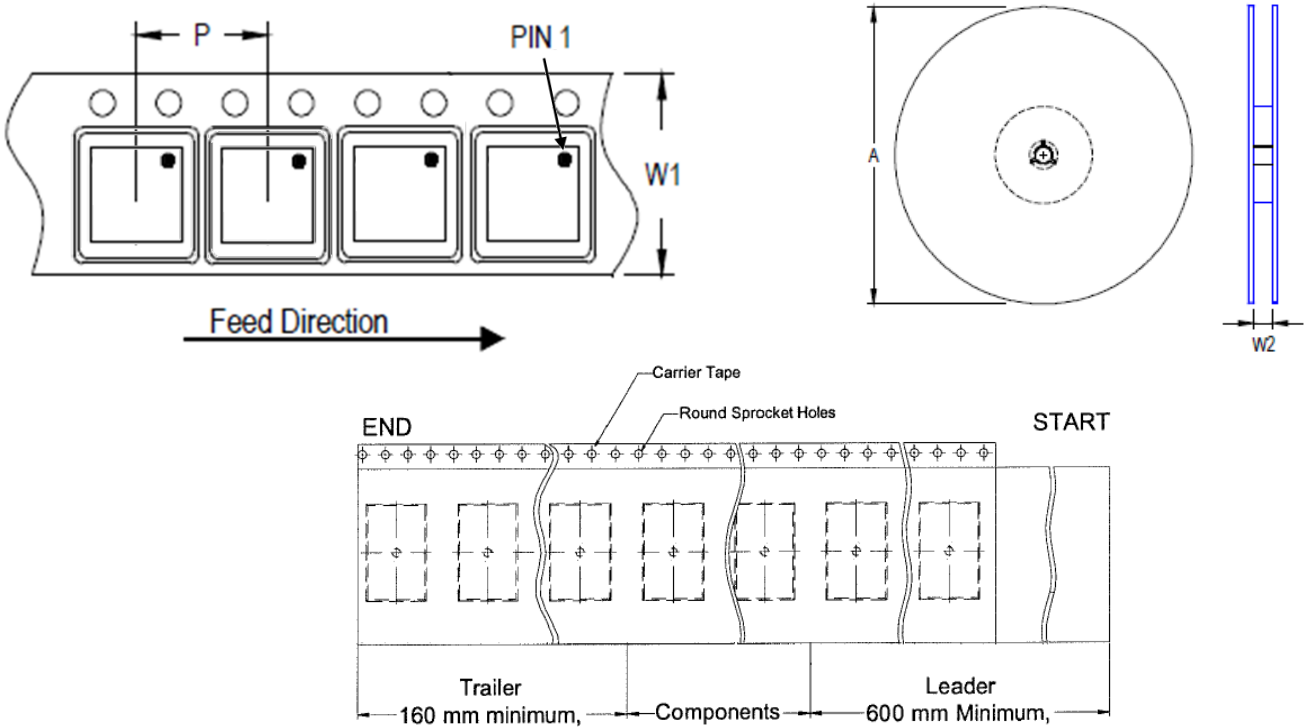

Package Type	Tape Size (W1) (mm)	Pocket Pitch (P) (mm)	Reel Size (A)		Units per Reel	Trailer (mm)	Leader (mm)	Reel Width (W2) Min/Max (mm)
			(mm)	(in)				
(Z) QFN/DFN 1x1	8	4	180	7	2,500	160	600	8.4/9.9

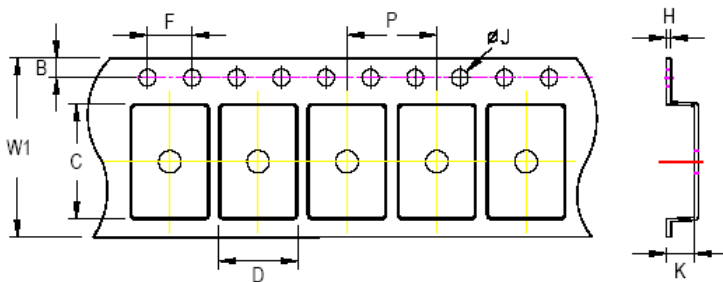







C, D, and K are determined by component size. The clearance between the components and the cavity is as follows:
 - For 8mm carrier tape: 0.5mm max.

Tape Size	W1		P		B		F		ØJ		K		H
	Max	Min	Max	Min	Max	Min	Max	Min	Max	Min	Max	Max	
8mm	8.3mm	3.9mm	4.1mm	1.65mm	1.85mm	3.9mm	4.1mm	1.5mm	1.6mm	0.5mm	0.6mm	0.6mm	

21.2 Tape and Reel Packing







21.2.1 TSOT-23-5

Step	Photo/Description	Step	Photo/Description
1	 <p>Reel 7"</p>	4	 <p>3 reels per inner box Box A</p>
2	 <p>HIC & Desiccant (1 Unit) inside</p>	5	 <p>12 inner boxes per outer box</p>
3	 <p>Caution label is on backside of Al bag</p>	6	 <p>Outer box Carton A</p>

Container Package	Reel		Box			Carton		
	Size	Units	Item	Reels	Units	Item	Boxes	Unit
TSOT-23-5	7"	3,000	Box A	3	9,000	Carton A	12	108,000
			Box E	1	3,000	For Combined or Partial Reel.		







21.2.2 ZQFN-4L 1x1

21.2.2.1 Quadrant 1

Step	Photo/Description	Step	Photo/Description
1	 Reel 7"	4	 3 reels per inner box Box A
2	 HIC & Desiccant (1 Unit) inside	5	 12 inner boxes per outer box
3	 Caution label is on backside of Al bag	6	 Outer box Carton A

Container Package	Reel		Box			Carton		
	Size	Units	Item	Reels	Units	Item	Boxes	Unit
(Z) QFN/DFN 1x1	7"	2,500	Box A	3	7,500	Carton A	12	90,000
			Box E	1	2,500	For Combined or Partial Reel.		

21.2.2.2 Quadrant 2

Step	Photo/Description	Step	Photo/Description
1	 Reel 7"	4	 3 reels per inner box Box A
2	 HIC & Desiccant (1 Unit) inside	5	 12 inner boxes per outer box
3	 Caution label is on backside of Al bag	6	 Outer box Carton A

Container Package	Reel		Box			Carton		
	Size	Units	Item	Reels	Units	Item	Boxes	Unit
(Z) QFN/DFN 1x1	7"	2,500	Box A	3	7,500	Carton A	12	90,000
			Box E	1	2,500			

21.3 Packing Material Anti-ESD Property

Surface Resistance	Aluminum Bag	Reel	Cover Tape	Carrier tape	Tube	Protection Band
Ω/cm^2	10^4 to 10^{11}	10^4 to 10^{11}	10^4 to 10^{11}	10^4 to 10^{11}	10^4 to 10^{11}	10^4 to 10^{11}

Richtek Technology Corporation

14F, No. 8, Tai Yuen 1st Street, Chupei City
 Hsinchu, Taiwan, R.O.C.
 Tel: (8863)5526789



Richtek products are sold by description only. Richtek reserves the right to change the circuitry and/or specifications without notice at any time. Customers should obtain the latest relevant information and data sheets before placing orders and should verify that such information is current and complete. Richtek cannot assume responsibility for use of any circuitry other than circuitry entirely embodied in a Richtek product. Information furnished by Richtek is believed to be accurate and reliable. However, no responsibility is assumed by Richtek or its subsidiaries for its use; nor for any infringements of patents or other rights of third parties which may result from its use. No license is granted by implication or otherwise under any patent or patent rights of Richtek or its subsidiaries.

Copyright © 2024 Richtek Technology Corporation. All rights reserved. **RICHTEK** is a registered trademark of Richtek Technology Corporation.

22 Datasheet Revision History

Version	Date	Description	Item
08	2024/3/22	Modify	Rewrite
09	2024/11/11	Modify	<i>General Description on page 1</i> <i>Features on page 1</i> <i>Ordering Information on page 1</i> <i>Electrical Characteristics on page 6</i> <i>Typical Application Circuit on page 7</i> <i>Application Information on page 13, 16</i> <i>Packing Information on page 20 to 26</i> - Added packing information