



Mn-Zn

Ferrites for EMI suppression

T series (Ring-shape)

REMINDERS FOR USING THESE PRODUCTS

Please be sure to read this manual thoroughly before using the products.

The products listed on this catalog are intended for use in general electronic equipment (AV equipment, telecommunications equipment, home appliances, amusement equipment, computer equipment, personal equipment, office equipment, measurement equipment, industrial robots) under a normal operation and use condition.

The products are not designed or warranted to meet the requirements of the applications listed below, whose performance and/or quality require a more stringent level of safety or reliability, or whose failure, malfunction or trouble could cause serious damage to society, person or property.

Please understand that we are not responsible for any damage or liability caused by use of the products in any of the applications below or for any other use exceeding the range or conditions set forth in this specification sheet.

If you intend to use the products in the applications listed below or if you have special requirements exceeding the range or conditions set forth in the each catalog, please contact us.

- | | |
|---|--|
| (1) Aerospace/aviation equipment | (9) Military equipment |
| (2) Transportation equipment (cars, electric trains, ships, etc.) | (10) Electric heating apparatus, burning equipment |
| (3) Medical equipment | (11) Disaster prevention/crime prevention equipment |
| (4) Power-generation control equipment | (12) Safety equipment |
| (5) Atomic energy-related equipment | (13) Other applications that are not considered general-purpose applications |
| (6) Seabed equipment | |
| (7) Transportation control equipment | |
| (8) Public information-processing equipment | |

When using these products in general purposes and standard use, it is recommended that protection circuits are used, devices are secured, and backup circuits are kept for increased safety.

Ferrites for EMI suppression

Product compatible with RoHS directive
Halogen-free

Overview of the T series

FEATURES

- Select various materials according to the noise frequency.
- The product has a wide range of sizes ranging from $\varnothing 14$ to $\varnothing 104$ outer diameters.
- Epoxy coating is also available.

APPLICATION

- Imaging devices, audio equipment, automotive electronics, communication devices, office electronics, industrial equipment, other
- Absorption EMI and penetrating noise
 - Prevent parasitic oscillation

PART NUMBER CONSTRUCTION

For general use

HF90	T	14	×	7	×	8
Material	Core shape	Outside diameter		Height		Inside diameter

RANGE OF USE AND STORAGE TEMPERATURE

Temperature range*	
Operating temperature (°C)	Storage temperature** (°C)
-40 to +85	-40 to +85

- RoHS Directive Compliant Product: See the following for more details. <https://product.tdk.com/info/en/environment/rohs/index.html>
- Halogen-free: indicates that Cl content is less than 900ppm, Br content is less than 900ppm, and that the total Cl and Br content is less than 1500ppm.

 Please be sure to request delivery specifications that provide further details on the features and specifications of the products for proper and safe use.
Please note that the contents may change without any prior notice due to reasons such as upgrading.

Mn-Zn T series (HF60)



SHAPE & DIMENSIONS

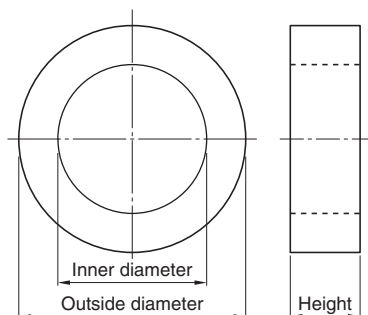

HF60	T	14	×	7	×	8
Material	Core shape	Outside diameter		Height		Inside diameter

Part No.	Outside diameter (mm)	Height (mm)	Inner diameter (mm)
HF60T14X7X8	14.0±0.5	7.0±0.5	8.0±0.5
HF60T18X10X10	18.0±0.7	10.0±0.5	10.0±0.7
HF60T22X10X14	22.0±0.7	10.0±0.5	14.0±0.7
HF60T25X13X15	25.0±1.0	13.0±1.0	15.0±1.0
HF60T28X13X16	28.0±1.0	13.0±1.0	16.0±1.0
HF60T31X13X19	31.0±1.0	13.0±1.0	19.0±1.0
HF60T38X14X22	38.0±1.0	14.0±1.0	22.0±1.0
HF60T44.5X13X30	44.5±1.0	13.0±1.0	30.0±1.0
HF60T62X13X39	62.5±1.3	13.5±1.0	39.0±1.3
HF60T80X20X50	80.0±1.6	20.0±1.0	50.0±1.6
HF60T104X20X80	104.0±2.0	20.0±1.0	80.0±2.0

Mn-Zn T series (HF60)

ELECTRICAL CHARACTERISTICS

IMPEDANCE VS. FREQUENCY CHARACTERISTICS

HF60T14X7X8

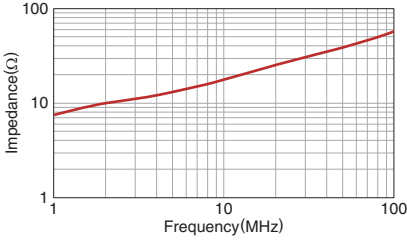

HF60T18X10X10

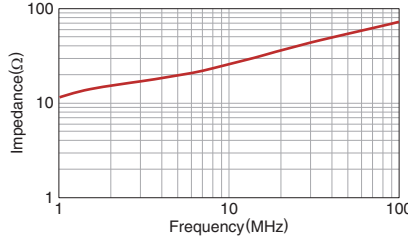

HF60T22X10X14

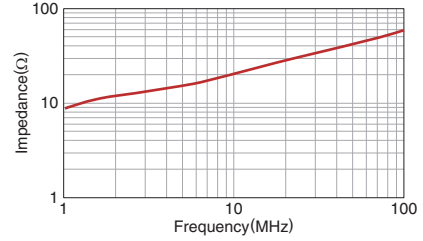

HF60T25X13X15

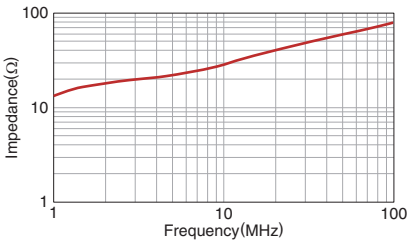

HF60T28X13X16

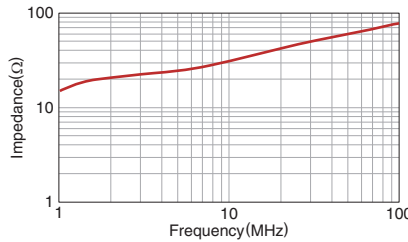

HF60T31X13X19

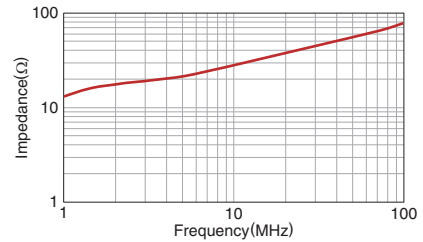

HF60T38X14X22

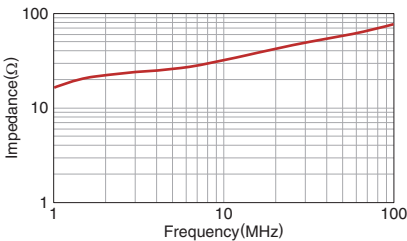

HF60T44.5X13X30

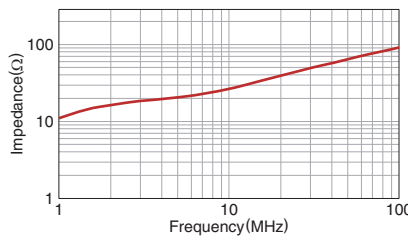

HF60T62X13X39

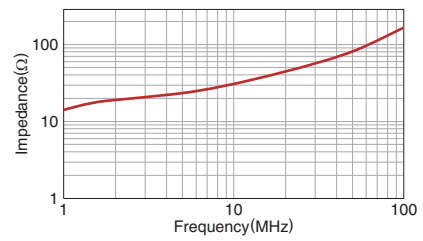

HF60T80X20X50

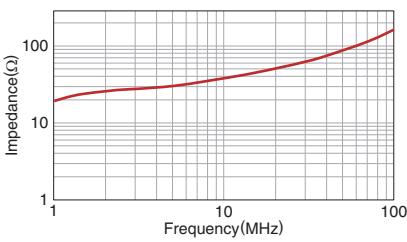

HF60T104X20X80

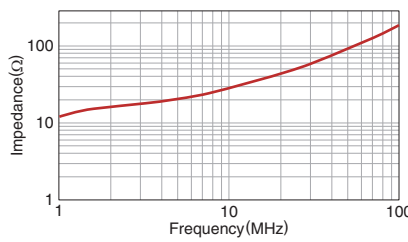

 Please be sure to request delivery specifications that provide further details on the features and specifications of the products for proper and safe use. Please note that the contents may change without any prior notice due to reasons such as upgrading.

Mn-Zn T series (HF90)



SHAPE & DIMENSIONS

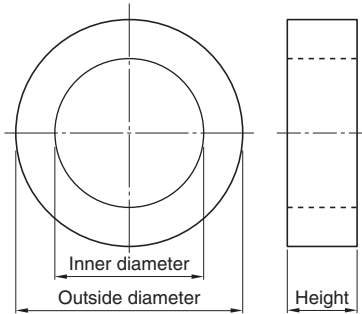

HF90	T	14	×	7	×	8
Material	Core shape	Outside diameter		Height		Inside diameter

Part No.	Outside diameter (mm)	Height (mm)	Inner diameter (mm)
HF90T14X7X8	14.0±0.3	7.0±0.2	8.0±0.3
HF90T18X10X10	18.0±0.4	10.0±0.3	10.0±0.3
HF90T22X10X14	22.0±0.4	10.0±0.3	14.0±0.3
HF90T25X13X15	25.0±0.4	13.0±0.3	15.0±0.3
HF90T28X13X16	28.0±0.4	13.0±0.3	16.0±0.4
HF90T31X13X19	31.0±0.5	13.0±0.3	19.0±0.4
HF90T38X14X22	38.0±0.8	14.0±0.3	22.0±0.5
HF90T44.5X13X30	44.5±1.1	13.0±0.5	30.0±0.8
HF90T62X13X39	62.5±1.3	13.5±0.5	39.0±0.8
HF90T80X20X50	80.0±1.6	20.0±0.5	50.0±1.0
HF90T104X20X80	104.0±2.0	20.0±0.5	80.0±1.6

Mn-Zn T series (HF90)

ELECTRICAL CHARACTERISTICS

IMPEDANCE VS. FREQUENCY CHARACTERISTICS

HF90T14X7X8

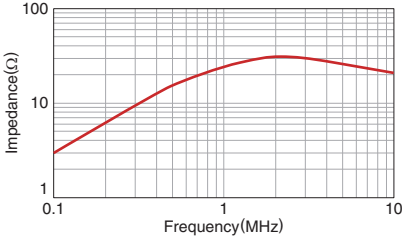

HF90T18X10X10

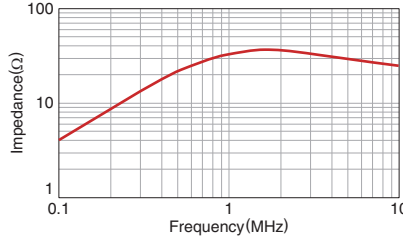

HF90T22X10X14

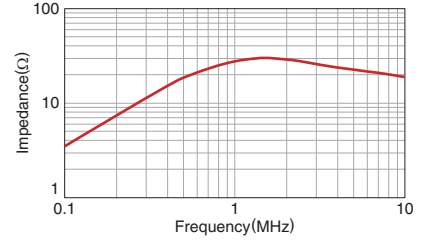

HF90T25X13X15

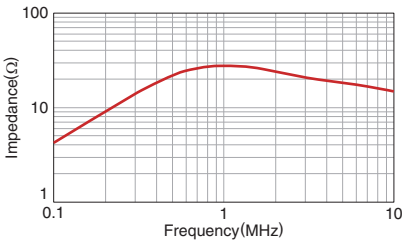

HF90T28X13X16

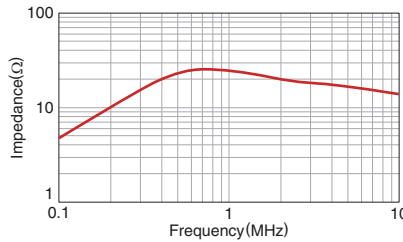

HF90T31X13X19

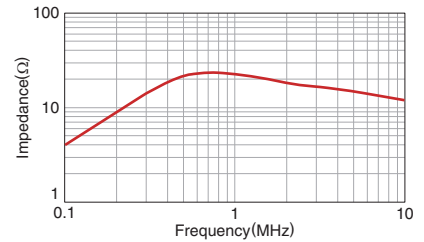

HF90T38X14X22

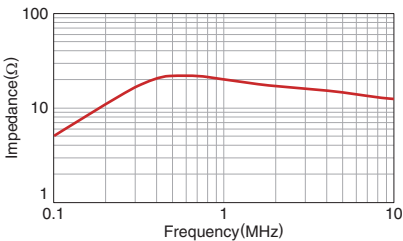

HF90T44.5X13X30

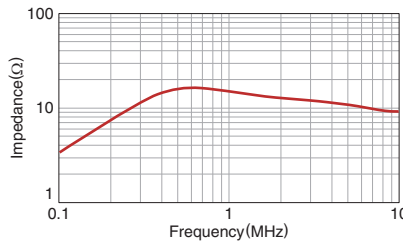

HF90T62X13X39

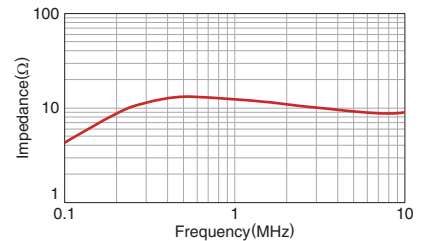

HF90T80X20X50

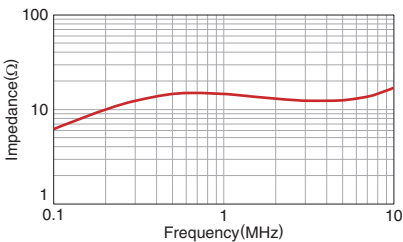

HF90T104X20X80

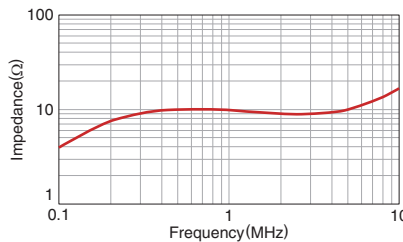

 Please be sure to request delivery specifications that provide further details on the features and specifications of the products for proper and safe use. Please note that the contents may change without any prior notice due to reasons such as upgrading.