



Isolator

SMD

CU4S0506 Series

5x5mm*

* Dimensions Code JIS

Caution

The products in this catalog will be or have been stopped production

Discontinue Issue Date	Dec.22, 2023
Last Purchase Order Date	Sep.30, 2024
Last Shipment Date	Dec.31, 2024

Please refer to our Web site about replacement information.

Isolator

Product compatible with RoHS directive

SMD

Overview of CU4S0506 Series

PART NUMBER CONSTRUCTION

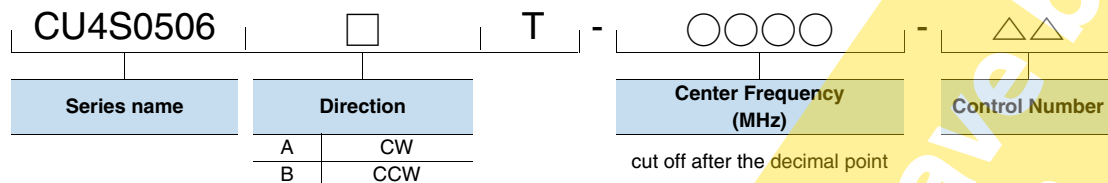

DIRECTION OF CIRCULATION

ClockWise(CW): A

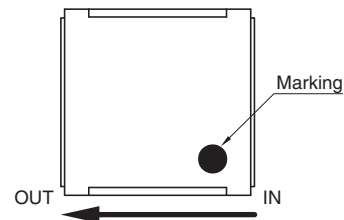

CounterClockWise(CCW): B

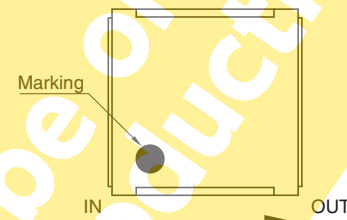

TEMPERATURE RANGE

Operating temperature (°C)	Storage temperature (°C)
-40 to +105	-40 to +105

RoHS Directive Compliant Product: See the following for more details related to RoHS Directive compliant products. <http://product.tdk.com/en/environment/rohs/>

- All specifications are subject to change without notice.
- Before using these products, be sure to request the delivery specifications.

CU4S0506 Series (Under 1GHz)

SHAPES AND DIMENSIONS

[Top view]

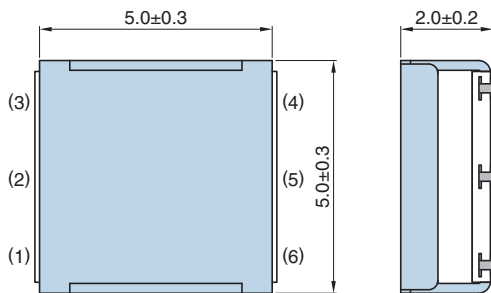

■ Terminal (Au plating)
 ■ Metal parts other than a terminal. (GND electric potential)

Tolerance unless otherwise specified: ± 0.2
 Coplanarity : 0.1max.

[Bottom view]

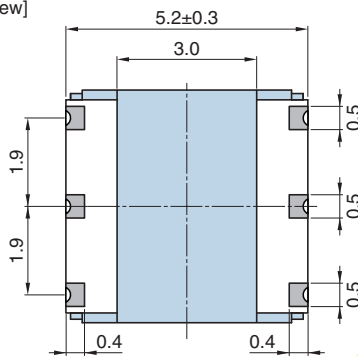

Terminal functions

1	OUT	IN
2	GROUND	GROUND
3	GROUND	GROUND
4	GROUND	GROUND
5	GROUND	GROUND
6	IN	OUT
Rotation	Clockwise	Counter Clockwise

Dimensions in mm

[Marking]

ClockWise(CW): A

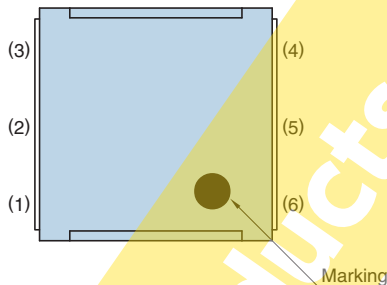

CounterClockWise(CCW): B

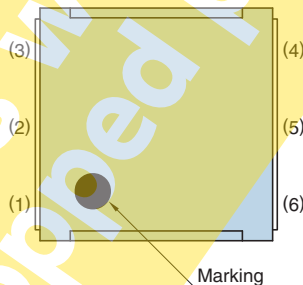

RECOMMENDED LAND PATTERN

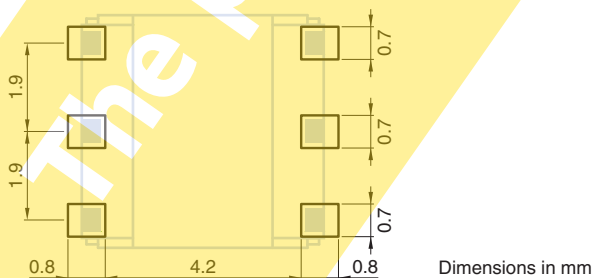

Dimensions in mm

RECOMMENDED PC BOARD PATTERN

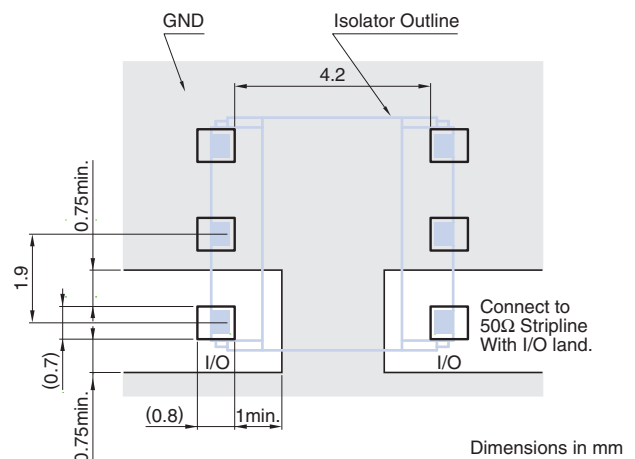

Dimensions in mm

- All specifications are subject to change without notice.
- Before using these products, be sure to request the delivery specifications.

CU4S0506 Series (Under 1GHz)

ELECTRICAL CHARACTERISTICS

Frequency range (MHz)	Center frequency (MHz)	Isolation (dB) min.	Insertion loss (dB) max.	V.S.W.R. $Z_0=50\Omega$ max.	Handling power (W) max.	Reflection power (W) ^{*4} max.	Part Number	
							ClockWise	CounterClockWise
703 to 748	725.5	9	1.30	1.8	5	2	CU4S0506AT-725-00	CU4S0506BT-725-00
758 to 803	780.5	9	1.30	1.8	5	2	CU4S0506AT-780-00	CU4S0506BT-780-00
859 to 894	876.5	11	1.00	1.8	5	2	CU4S0506AT-876-00	CU4S0506BT-876-00
869 to 894	881.5	12	0.85	1.7	5	2	CU4S0506AT-881-00	CU4S0506BT-881-00
880 to 915	897.5	11	0.95	1.8	5	2	CU4S0506AT-897-00	CU4S0506BT-897-00
925 to 960	942.5	11	0.95	1.8	5	2	CU4S0506AT-942-00	CU4S0506BT-942-00

Characteristic Impedance (Ω) : 50(Nominal)

*4 To be kept below +105deg.C at the bottom surface

The products will be or have stopped production

- All specifications are subject to change without notice.
- Before using these products, be sure to request the delivery specifications.

CU4S0506 Series (Over 1GHz)

SHAPES AND DIMENSIONS

[Top view]

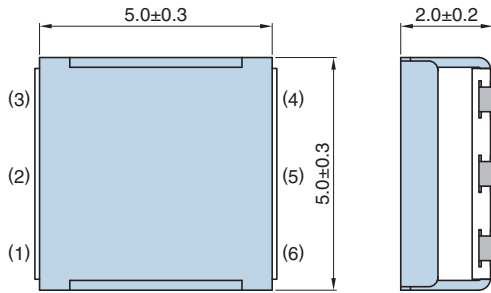

■ Terminal (Au plating)
 ■ Metal parts other than a terminal. (GND electric potential)

Tolerance unless otherwise specified: ± 0.2
 Coplanarity : 0.1max.

[Bottom view]

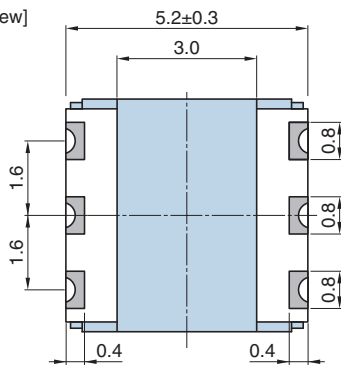

Terminal functions

1	OUT	IN
2	GROUND	GROUND
3	GROUND	GROUND
4	GROUND	GROUND
5	GROUND	GROUND
6	IN	OUT
Rotation	Clockwise	Counter Clockwise

Dimensions in mm

[Marking]

ClockWise(CW): A

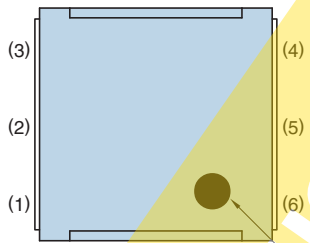

Marking

CounterClockWise(CCW): B

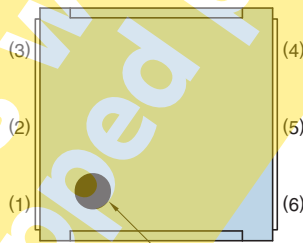

Marking

RECOMMENDED LAND PATTERN

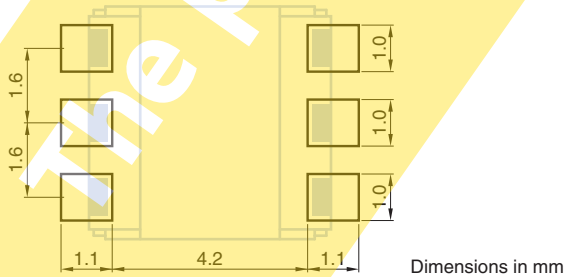

Dimensions in mm

RECOMMENDED PC BOARD PATTERN

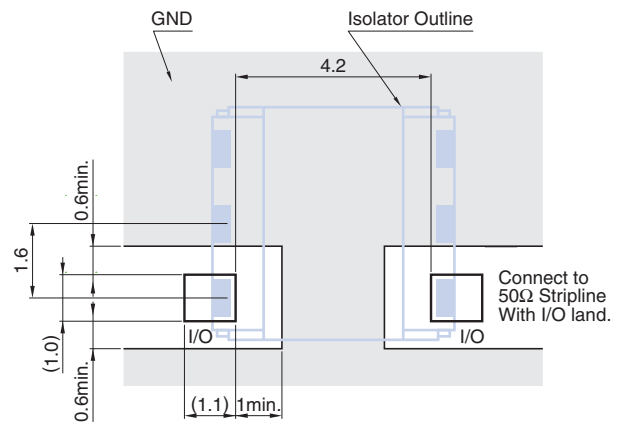

Dimensions in mm

- All specifications are subject to change without notice.
- Before using these products, be sure to request the delivery specifications.

CU4S0506 Series (Over 1GHz)

ELECTRICAL CHARACTERISTICS

Frequency range (MHz)	Center frequency (MHz)	Isolation (dB) min.	Insertion loss (dB) max.	V.S.W.R. Zo=50Ω max.	Handling power (W) max.	Reflection power (W) ^{*4} max.	Part Number	
							ClockWise	CounterClockWise
1805 to 1880	1842.5	14	0.70	1.5	5	2	CU4S0506AT-1842-00	CU4S0506BT-1842-00
1880 to 2025	1952.5	12	1.00	1.7	5	2	CU4S0506AT-1952-00	CU4S0506BT-1952-00
1930 to 1995	1962.5	15	0.70	1.5	5	2	CU4S0506AT-1962-00	CU4S0506BT-1962-00
2110 to 2200	2155	14	0.80	1.5	5	2	CU4S0506AT-2155-00	CU4S0506BT-2155-00
2300 to 2400	2350	14	0.80	1.5	5	2	CU4S0506AT-2350-00	CU4S0506BT-2350-00
2496 to 2690	2593	12	0.90	1.7	5	2	CU4S0506AT-2593-00	CU4S0506BT-2593-00
2570 to 2620	2595	15	0.70	1.5	5	2	CU4S0506AT-2595-00	CU4S0506BT-2595-00
2620 to 2690	2655	15	0.75	1.6	5	2	CU4S0506AT-2655-00	CU4S0506BT-2655-00

Characteristic Impedance (Ω) : 50(Nominal)

*4 To be kept below +105deg.C at the bottom surface

The products will be or have stopped production

- All specifications are subject to change without notice.
- Before using these products, be sure to request the delivery specifications.

CU4S0506 Series

PACKAGING STYLE

REEL DIMENSIONS

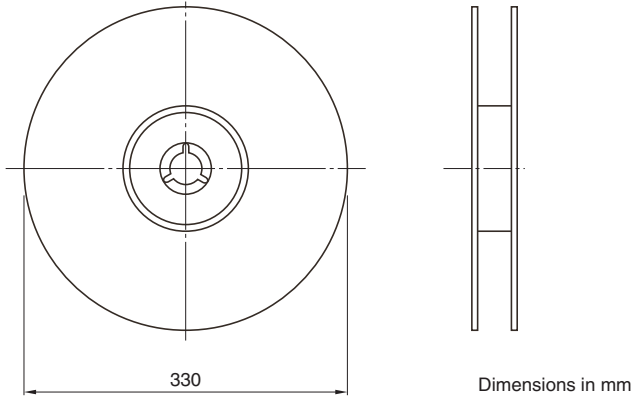

TAPE DIMENSIONS

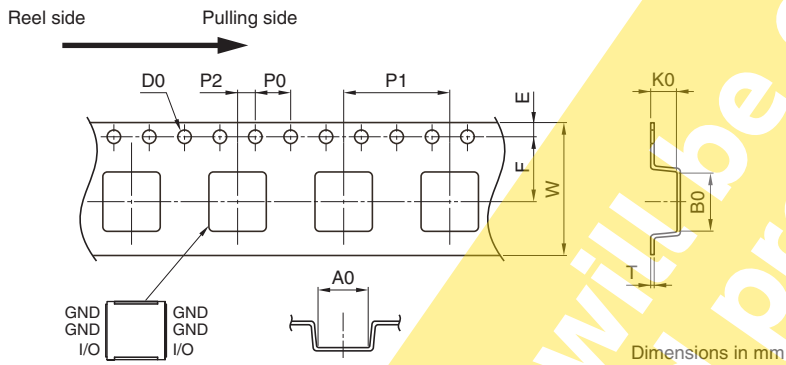

A0	B0	D0	E	F	P0	P1	P2	W	K0	T
5.6±0.1	5.6±0.1	1.5+0.1/-0	1.75±0.1	7.5±0.1	4.0±0.1	12.0±0.1	2.0±0.1	16.0+0.3/-0.1	2.6±0.1	0.3±0.05

PACKAGE QUANTITY

Standard package quantity
(pieces/reel)

1000

- All specifications are subject to change without notice.
- Before using these products, be sure to request the delivery specifications.

CU4S0506 Series

RECOMMENDED REFLOW PROFILE

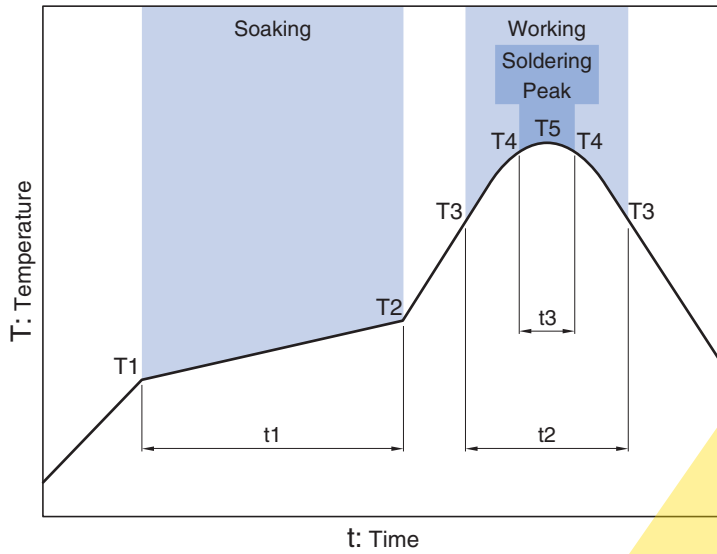

Soaking			Working		Soldering Peak		
Temp.	T2	Time	Temp.	Time	Temp.	Time	Temp.
T1	T2	t1	T3	t2	T4	t3	T5
150°C	180°C	60 to 120s	230°C	30 to 60s	250°C	within 10s	260°C max.

The products will be or have been stopped production

- All specifications are subject to change without notice.
- Before using these products, be sure to request the delivery specifications.

REMINDERS FOR USING THESE PRODUCTS

Before using these products, be sure to request the delivery specifications.

SAFETY REMINDERS

Please pay sufficient attention to the warnings for safe designing when using these products.

REMINDERS

Please do not bring the magnet close to the product (Recommending is separating to 50cm or more). An electric characteristic might be deteriorated.

The magnetic field of 5mT or more must not go into the product when you make the magnet approach.

Moreover, please do not touch a soft magnetic material such as iron (Recommending is separating to 10mm or more). An electric characteristic might be deteriorated. An electric characteristic changes when bringing it close within 10mm(reversible change).

There is a leakage of some magnetism (0.3T or less) from the product.

The products listed on this catalog are intended for use in general electronic equipment (AV equipment, telecommunications equipment, home appliances, amusement equipment, computer equipment, personal equipment, office equipment, measurement equipment, industrial robots) under a normal operation and use condition.

The products are not designed or warranted to meet the requirements of the applications listed below, whose performance and/or quality require a more stringent level of safety or reliability, or whose failure, malfunction or trouble could cause serious damage to society, person or property.

Please understand that we are not responsible for any damage or liability caused by use of the products in any of the applications below or for any other use exceeding the range or conditions set forth in this catalog.

- | | |
|---|--|
| (1) Aerospace/Aviation equipment | (8) Public information-processing equipment |
| (2) Transportation equipment (cars, electric trains, ships, etc.) | (9) Military equipment |
| (3) Medical equipment | (10) Electric heating apparatus, burning equipment |
| (4) Power-generation control equipment | (11) Disaster prevention/crime prevention equipment |
| (5) Atomic energy-related equipment | (12) Safety equipment |
| (6) Seabed equipment | (13) Other applications that are not considered general-purpose applications |
| (7) Transportation control equipment | |

When using this product in general-purpose applications, you are kindly requested to take into consideration securing protection circuit/equipment or providing backup circuits, etc., to ensure higher safety.