

COMPLEMENTARY PAIR ENHANCEMENT MODE MOSFET POWERDI

Product Summary

Device	V _{(BR)DSS}	R _{DS(ON)}	I _D T _A = +25°C
Q1	12V	17mΩ @ V _{GS} = 4.5V	9.5A
		25mΩ @ V _{GS} = 2.5V	7.8A
Q2	-20V	32mΩ @ V _{GS} = -4.5V	-6.9A
		53mΩ @ V _{GS} = -2.5V	-5.4A

Features and Benefits

- Thermally Efficient Package-Cooler Running Applications
- High Conversion Efficiency
- Low R_{DS(ON)} – Minimizes On State Losses
- Low Input Capacitance
- Fast Switching Speed
- **Totally Lead-Free & Fully RoHS Compliant (Notes 1 & 2)**
- **Halogen and Antimony Free. "Green" Device (Note 3)**
- **Qualified to AEC-Q101 Standards for High Reliability**

Description and Applications

This new generation Complementary Pair Enhancement Mode MOSFET has been designed to minimize R_{DS(ON)} and yet maintain superior switching performance. This device is ideal for use in Notebook battery power management and Loadswitch.

- Notebook Battery Power Management
- DC-DC Converters
- Loadswitch

Mechanical Data

- Case: PowerDI5060-8 (Type C)
- Case Material: Molded Plastic, "Green" Molding Compound. UL Flammability Classification Rating 94V-0
- Moisture Sensitivity: Level 1 per J-STD-020
- Terminals: Finish – 100% Matte Tin Annealed over Copper Leadframe. Solderable per MIL-STD-202, Method 208 (e3)
- Terminal Connections: See Diagram Below
- Weight: 0.097 grams (Approximate)

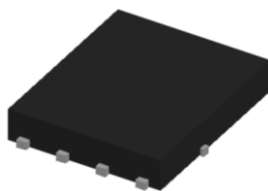

Top View

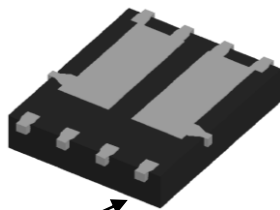

Bottom View
Pin1

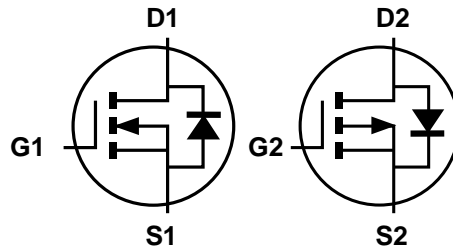

Q1 N-Channel MOSFET Q2 P-Channel MOSFET

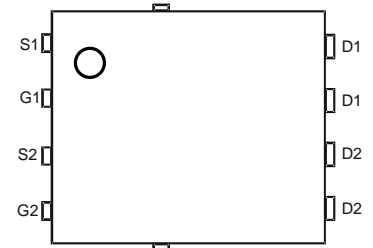

Top View
Pin Configuration

Ordering Information (Note 4)

Part Number	Case	Packaging
DMC1018UPD-13	PowerDI5060-8 (Type C)	2500 / Tape & Reel

- Notes:
1. No purposely added lead. Fully EU Directive 2002/95/EC (RoHS) & 2011/65/EU (RoHS 2) compliant
 2. See http://www.diodes.com/quality/lead_free.html for more information about Diodes Incorporated's definitions of Halogen- and Antimony-free, "Green" and Lead-free.
 3. Halogen- and Antimony-free "Green" products are defined as those which contain <900ppm bromine, <900ppm chlorine (<1500ppm total Br + Cl) and <1000ppm antimony compounds.
 4. For packaging details, go to our website at <http://www.diodes.com/products/packages.html>.

Marking Information

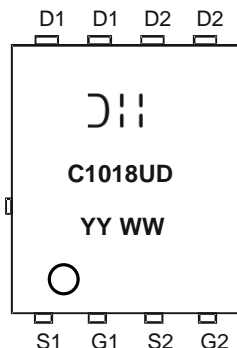

⌋⌋⌋ = Manufacturer's Marking
 C1018UD = Product Type Marking Code
 YYWW = Date Code Marking
 YY = Year (ex: 15 = 2015)
 WW = Week (01 - 53)

Maximum Ratings (@T_A = +25°C, unless otherwise specified.)

Characteristic			Symbol	Q1 Value	Q2 Value	Units
Drain-Source Voltage			V _{DSS}	12	-20	V
Gate-Source Voltage			V _{GSS}	±8	±12	V
Continuous Drain Current (Note 5) V _{GS} = 4.5V	Steady State	T _A = +25°C T _A = +70°C	I _D	9.5 7.6	-6.9 -5.5	A
	t < 10s	T _A = +25°C T _A = +70°C	I _D	13.0 10.4	-9.4 -7.5	A
Maximum Body Diode Forward Current (Note 5)			I _S	2.5	-2.5	A
Pulsed Drain Current (10µs pulse, duty cycle = 1%)			I _{DM}	60	-40	A
Avalanche Current (Note 6) L = 0.1mH			I _{AS}	20	-17	A
Avalanche Energy (Note 6) L = 0.1mH			E _{AS}	25	14	mJ

Thermal Characteristics

Characteristic		Symbol	Value	Units
Total Power Dissipation (Note 5)	T _A = +25°C	P _D	2.3	W
	T _A = +70°C		1.5	
Thermal Resistance, Junction to Ambient (Note 5)	Steady State	R _{θJA}	54	°C/W
	t < 10s		29	
Thermal Resistance, Junction to Case		R _{θJC}	6.5	
Operating and Storage Temperature Range		T _J , T _{STG}	-55 to +150	°C

Electrical Characteristics Q1 N-Channel (@T_A = +25°C, unless otherwise specified.)

Characteristic	Symbol	Min	Typ	Max	Unit	Test Condition
OFF CHARACTERISTICS (Note 7)						
Drain-Source Breakdown Voltage	BV _{DSS}	12	—	—	V	V _{GS} = 0V, I _D = 250µA
Zero Gate Voltage Drain Current	I _{DSS}	—	—	1	µA	V _{DS} = 12V, V _{GS} = 0V
Gate-Source Leakage	I _{GSS}	—	—	±100	nA	V _{GS} = ±8V, V _{DS} = 0V
ON CHARACTERISTICS (Note 7)						
Gate Threshold Voltage	V _{GS(TH)}	0.6	0.8	1.5	V	V _{DS} = V _{GS} , I _D = 250µA
Static Drain-Source On-Resistance	R _{DS(ON)}	—	8	17	mΩ	V _{GS} = 4.5V, I _D = 11.8A
		—	11	25		V _{GS} = 2.5V, I _D = 9.8A
Diode Forward Voltage	V _{SD}	—	0.7	1.2	V	V _{GS} = 0V, I _S = 2.9A
DYNAMIC CHARACTERISTICS (Note 8)						
Input Capacitance	C _{iss}	—	1525	—	pF	V _{DS} = 6V, V _{GS} = 0V, f = 1.0MHz
Output Capacitance	C _{oss}	—	329	—		
Reverse Transfer Capacitance	C _{rss}	—	303	—		
Gate Resistance	R _G	—	1.6	—	Ω	V _{DS} = 0V, V _{GS} = 0V, f = 1.0MHz
Total Gate Charge (V _{GS} = 4.5V)	Q _g	—	17.1	—	nC	V _{DS} = 6V, I _D = 11.8A
Total Gate Charge (V _{GS} = 8V)	Q _g	—	30.4	—		
Gate-Source Charge	Q _{gs}	—	2.6	—		
Gate-Drain Charge	Q _{gd}	—	4.3	—		
Turn-On Delay Time	t _{D(ON)}	—	6.6	—	ns	V _{DD} = 6V, R _L = 6Ω V _{GS} = 4.5V, R _G = 6Ω, I _D = 1A
Turn-On Rise Time	t _R	—	10.8	—		
Turn-Off Delay Time	t _{D(OFF)}	—	41.5	—		
Turn-Off Fall Time	t _F	—	21.9	—		
Body Diode Reverse Recovery Time	t _{RR}	—	14.3	—	ns	I _F = 11.8A, di/dt = 100A/µs
Body Diode Reverse Recovery Charge	Q _{RR}	—	2.3	—	nC	I _F = 11.8A, di/dt = 100A/µs

Electrical Characteristics Q2 P-Channel (@ $T_A = +25^\circ\text{C}$, unless otherwise specified.)

Characteristic	Symbol	Min	Typ	Max	Unit	Test Condition
OFF CHARACTERISTICS (Note 7)						
Drain-Source Breakdown Voltage	BV_{DSS}	-20	—	—	V	$V_{GS} = 0V, I_D = -250\mu A$
Zero Gate Voltage Drain Current	I_{DSS}	—	—	-1	μA	$V_{DS} = -16V, V_{GS} = 0V$
Gate-Source Leakage	I_{GSS}	—	—	± 100	nA	$V_{GS} = \pm 12V, V_{DS} = 0V$
ON CHARACTERISTICS (Note 7)						
Gate Threshold Voltage	$V_{GS(TH)}$	-0.6	-0.8	-1.5	V	$V_{DS} = V_{GS}, I_D = -250\mu A$
Static Drain-Source On-Resistance	$R_{DS(ON)}$	—	22	32	m Ω	$V_{GS} = -4.5V, I_D = -8.9A$
		—	31	53		$V_{GS} = -2.5V, I_D = -6.9A$
Diode Forward Voltage	V_{SD}	—	-0.7	-1.2	V	$V_{GS} = 0V, I_S = -2.9A$
DYNAMIC CHARACTERISTICS (Note 8)						
Input Capacitance	C_{iss}	—	866	—	pF	$V_{DS} = -6V, V_{GS} = 0V, f = 1.0MHz$
Output Capacitance	C_{oss}	—	167	—		
Reverse Transfer Capacitance	C_{riss}	—	131	—		
Gate Resistance	R_G	—	4.9	—	Ω	$V_{DS} = 0V, V_{GS} = 0V, f = 1.0MHz$
Total Gate Charge ($V_{GS} = -4.5V$)	Q_g	—	8.6	—	nC	$V_{DS} = -6V, I_D = -8.9A$
Total Gate Charge ($V_{GS} = -8V$)	Q_g	—	19	—		
Gate-Source Charge	Q_{gs}	—	1.5	—		
Gate-Drain Charge	Q_{gd}	—	2.5	—		
Turn-On Delay Time	$t_{D(ON)}$	—	5.8	—	ns	$V_{DD} = -6V, R_L = 6\Omega, V_{GS} = -4.5V, R_G = 6\Omega, I_D = -1A$
Turn-On Rise Time	t_R	—	7.7	—		
Turn-Off Delay Time	$t_{D(OFF)}$	—	28.1	—		
Turn-Off Fall Time	t_F	—	14.6	—		
Body Diode Reverse Recovery Time	t_{RR}	—	9.8	—	ns	$I_F = -8.9A, di/dt = -100A/\mu s$
Body Diode Reverse Recovery Charge	Q_{RR}	—	2.7	—	nC	$I_F = -8.9A, di/dt = -100A/\mu s$

- Notes:
5. Device mounted on FR-4 substrate PC board, 2oz copper, with 1inch square copper plate.
 6. I_{AS} and E_{AS} rating are based on low frequency and duty cycles to keep $T_J = +25^\circ\text{C}$.
 7. Short duration pulse test used to minimize self-heating effect.
 8. Guaranteed by design. Not subject to product testing.

Typical Characteristics - N-CHANNEL

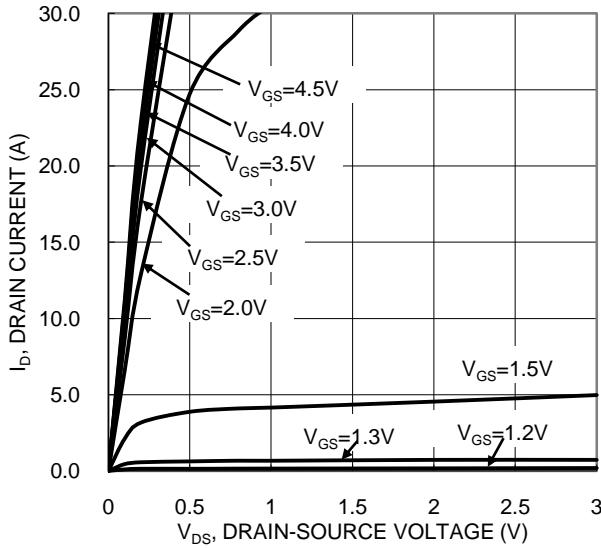

Figure 1. Typical Output Characteristic

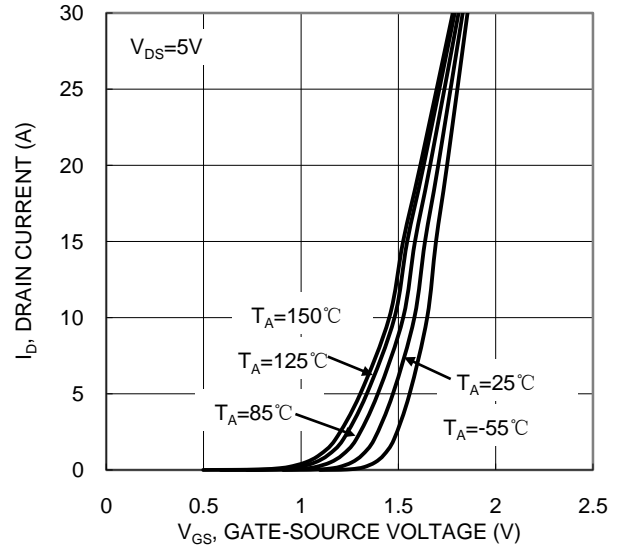

Figure 2. Typical Transfer Characteristic

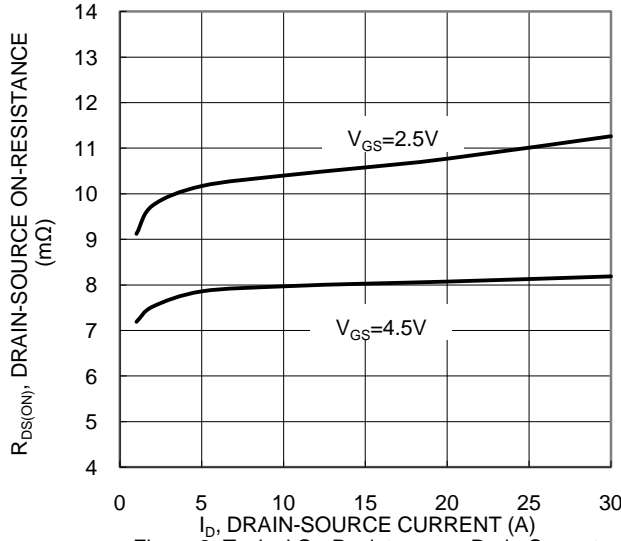

Figure 3. Typical On-Resistance vs Drain Current and Gate Voltage

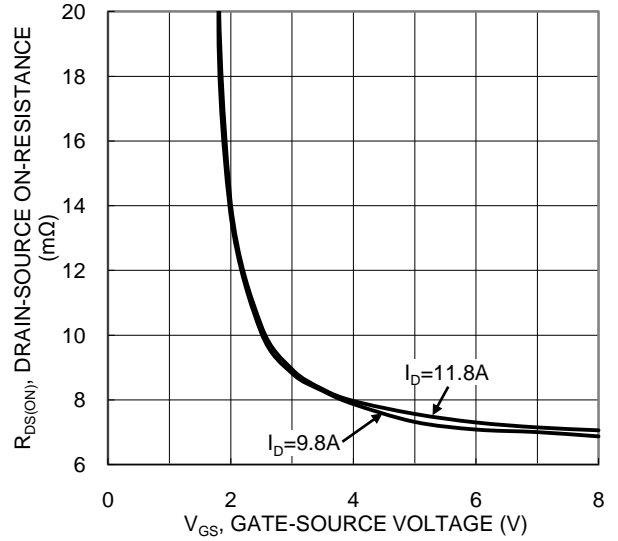

Figure 4. Typical Transfer Characteristic

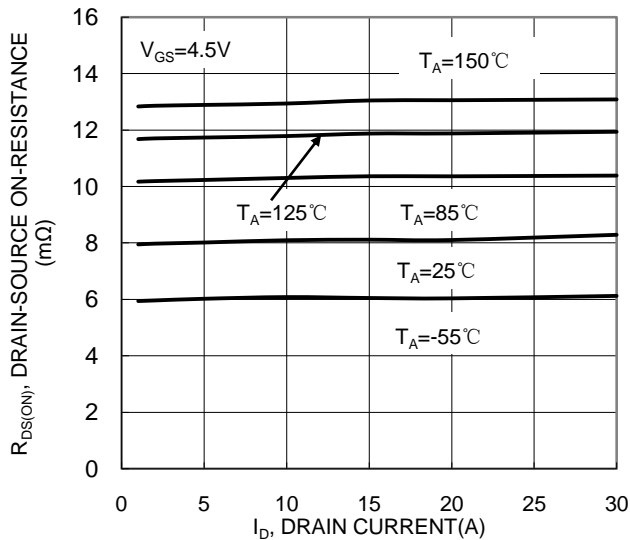

Figure 5. Typical On-Resistance vs Drain Current and Junction Temperature

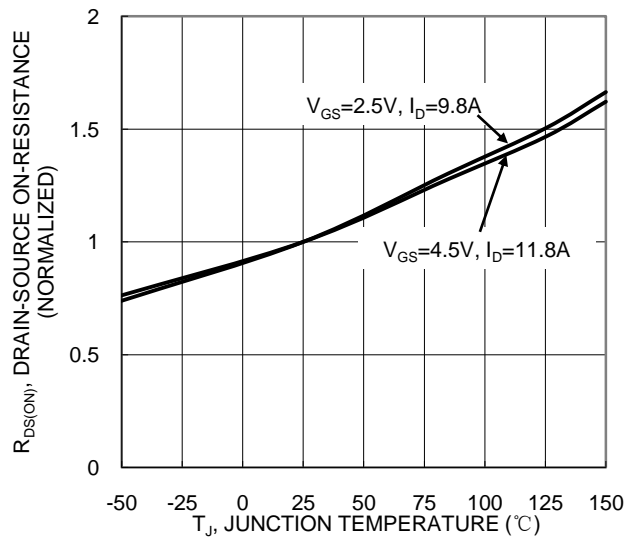

Figure 6. On-Resistance Variation with Junction Temperature

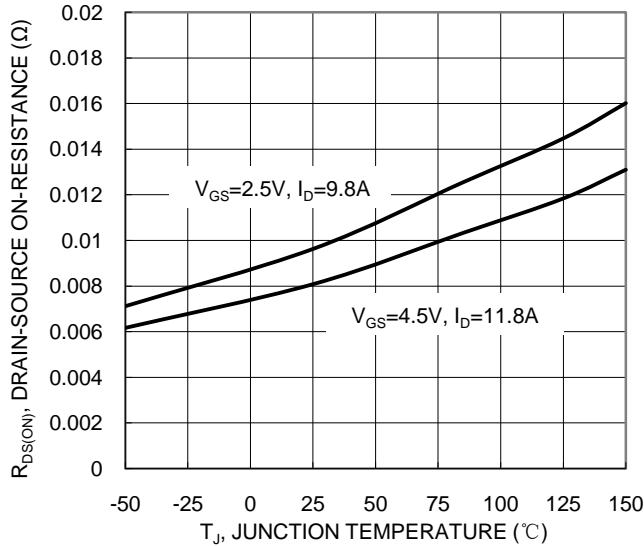

Figure 7. On-Resistance Variation with Junction Temperature

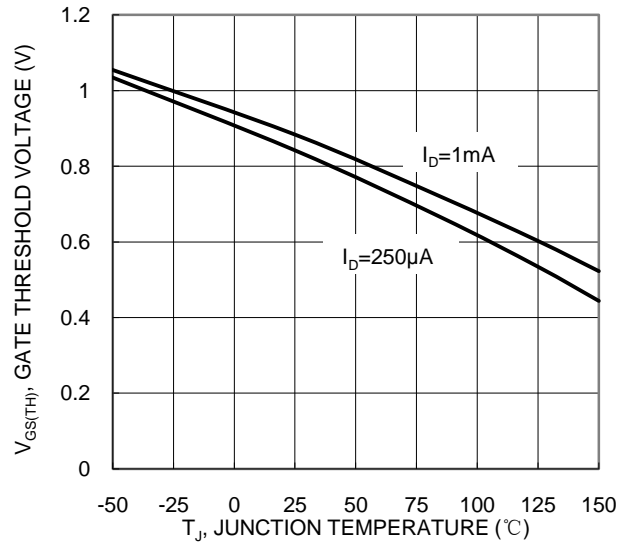

Figure 8. Gate Threshold Variation vs Junction Temperature

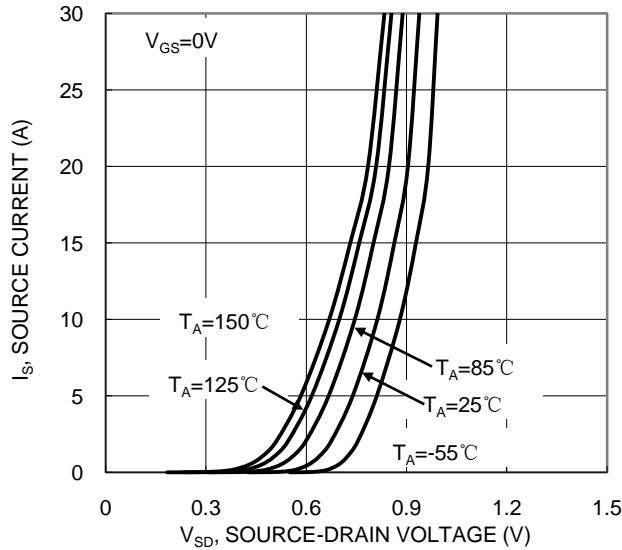

Figure 9. Diode Forward Voltage vs Current

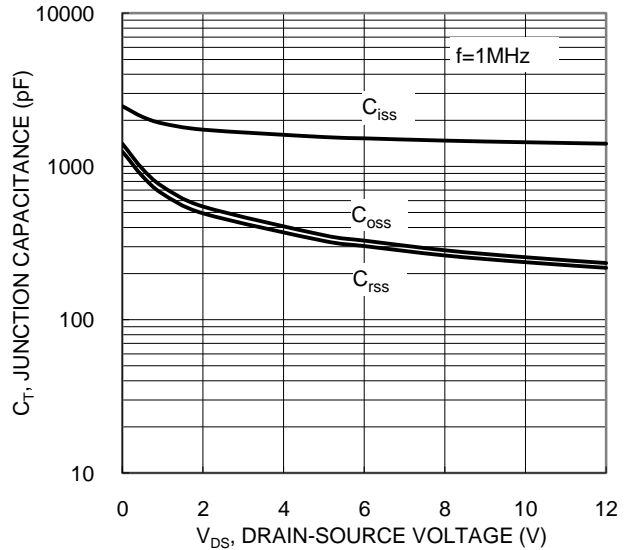

Figure 10. Typical Junction Capacitance

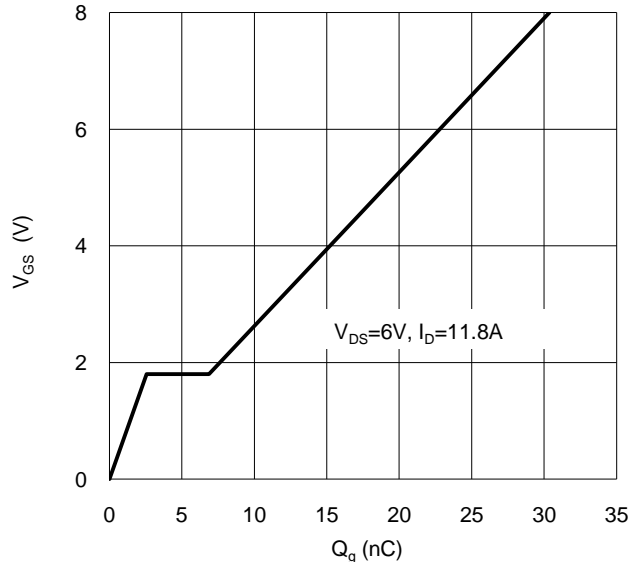

Figure 11. Gate Charge

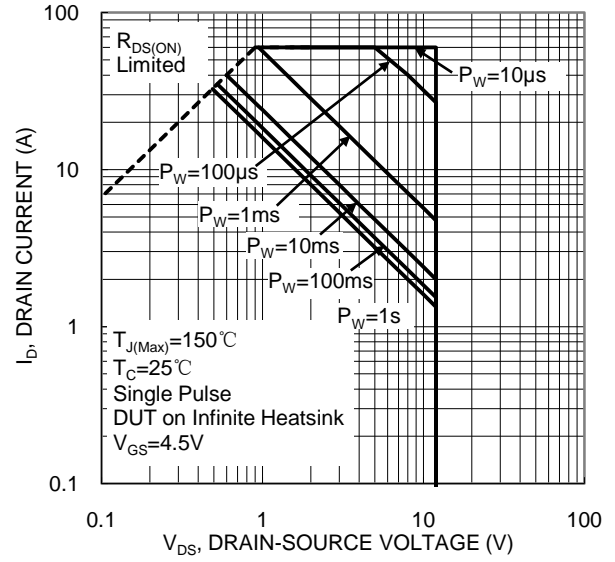

Figure 12. SOA, Safe Operation Area

Typical Characteristics - P-CHANNEL

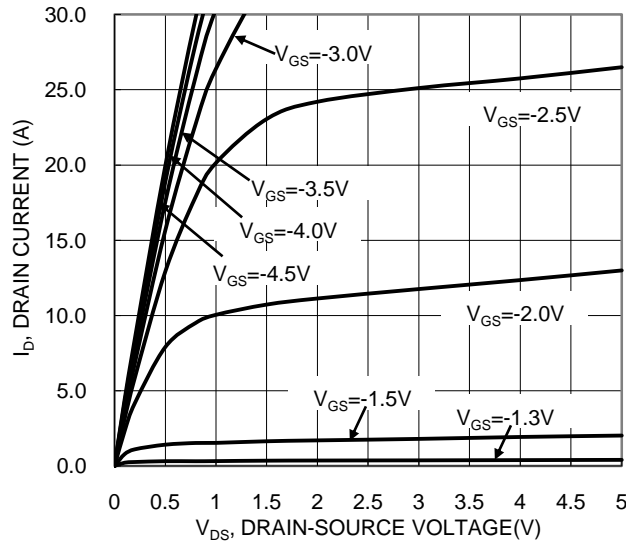

Figure 13. Typical Output Characteristic

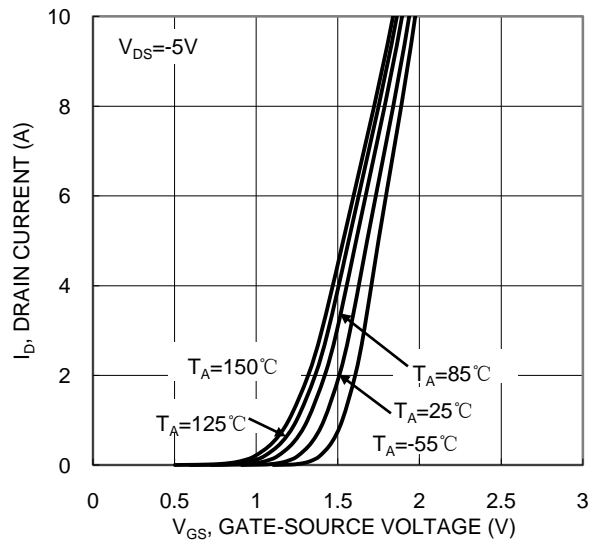

Figure 14. Typical Transfer Characteristic

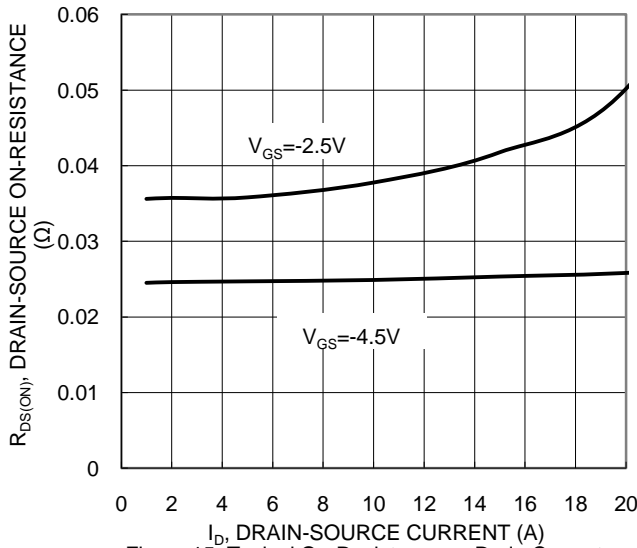

Figure 15. Typical On-Resistance vs Drain Current and Gate Voltage

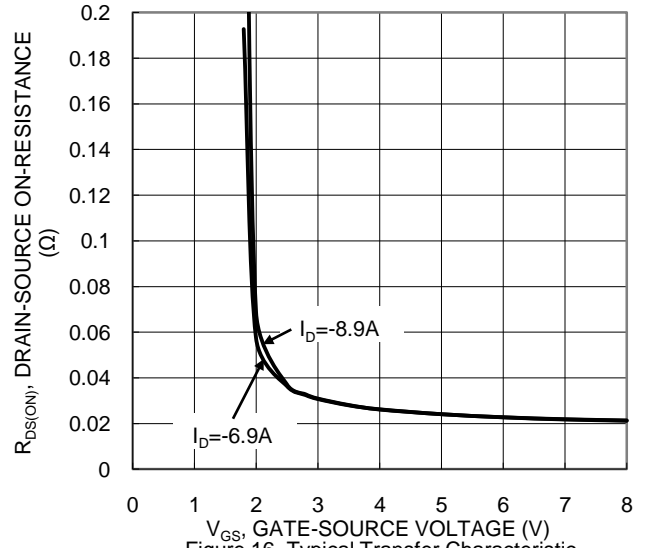

Figure 16. Typical Transfer Characteristic

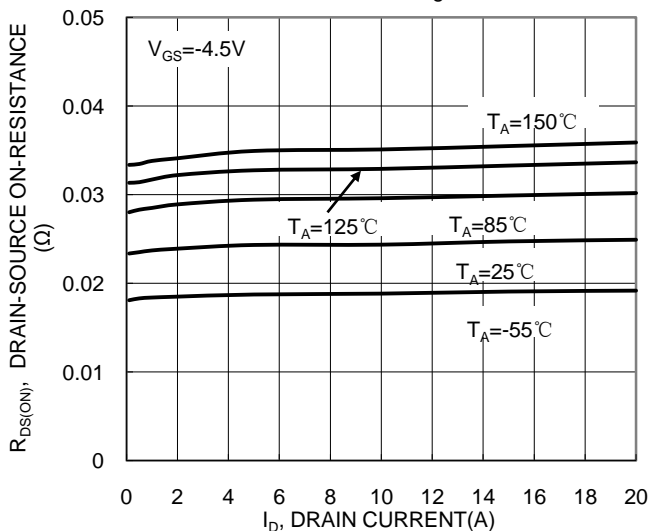

Figure 17. Typical On-Resistance vs Drain Current and Temperature

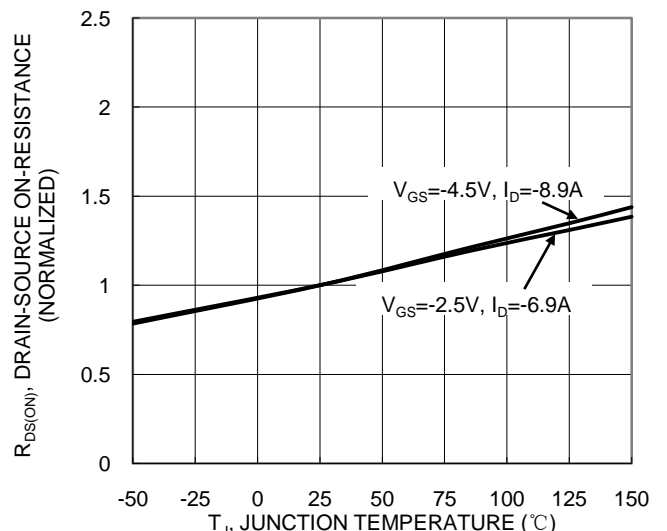
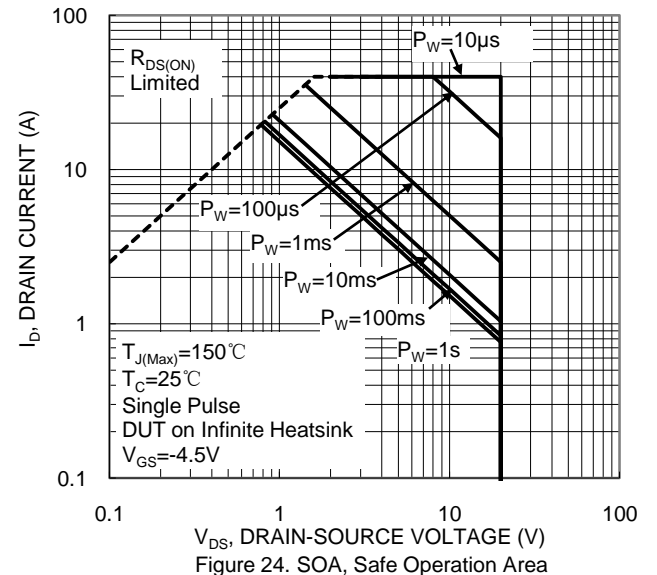
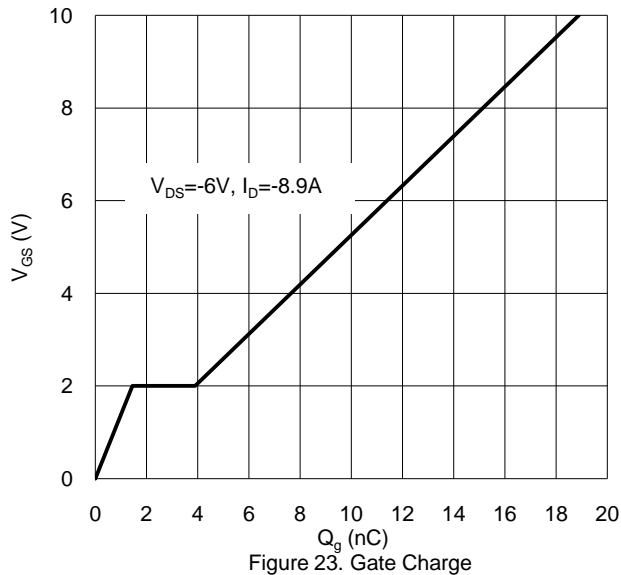
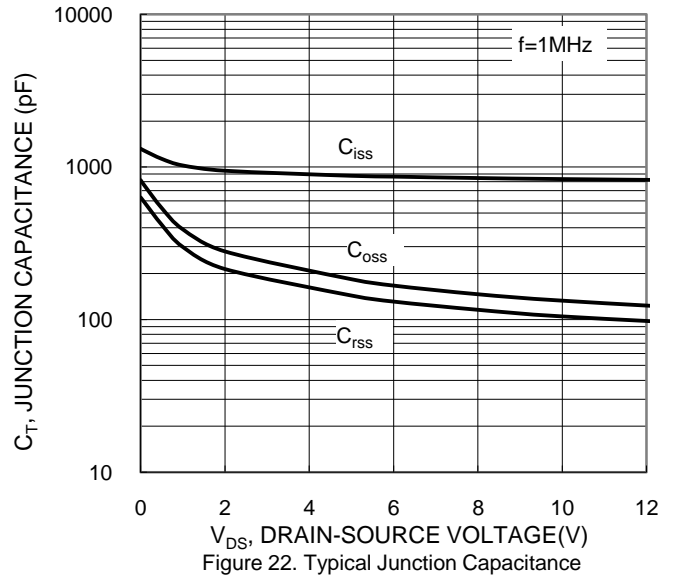
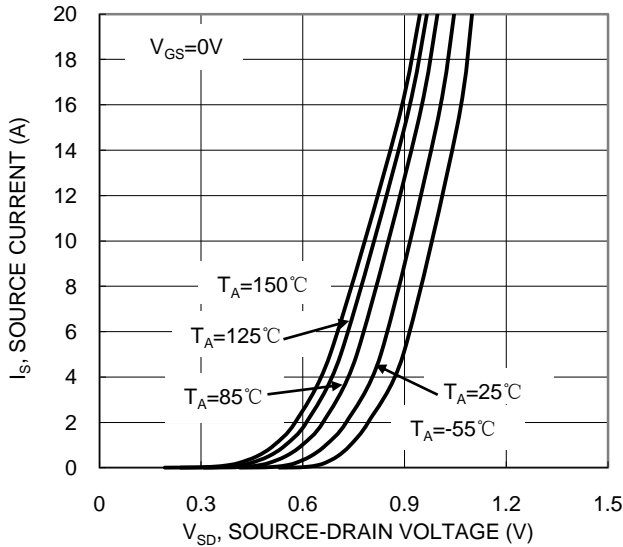
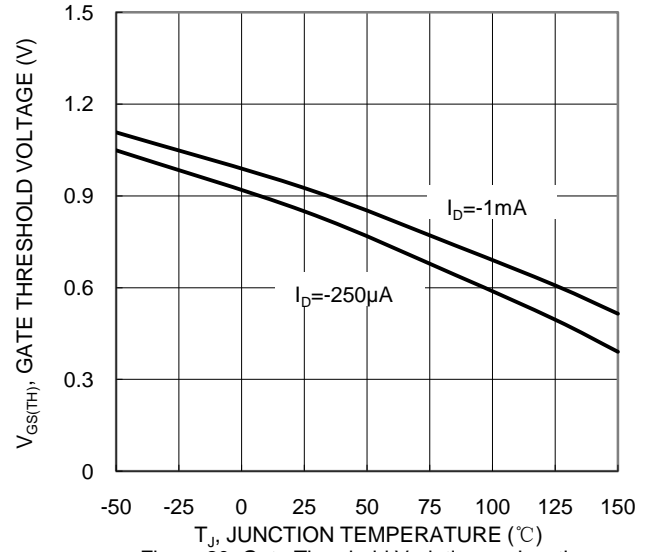
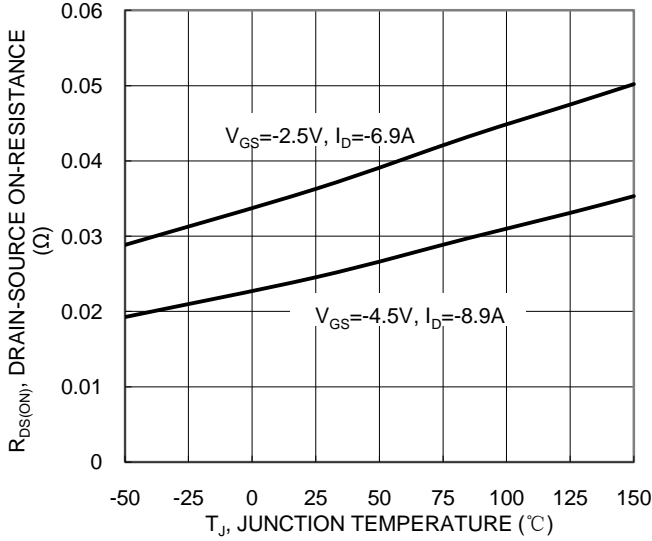

Figure 18. On-Resistance Variation with Temperature



Package Outline Dimensions

Please see <http://www.diodes.com/package-outlines.html> for the latest version.

PowerDI5060-8 (Type C)

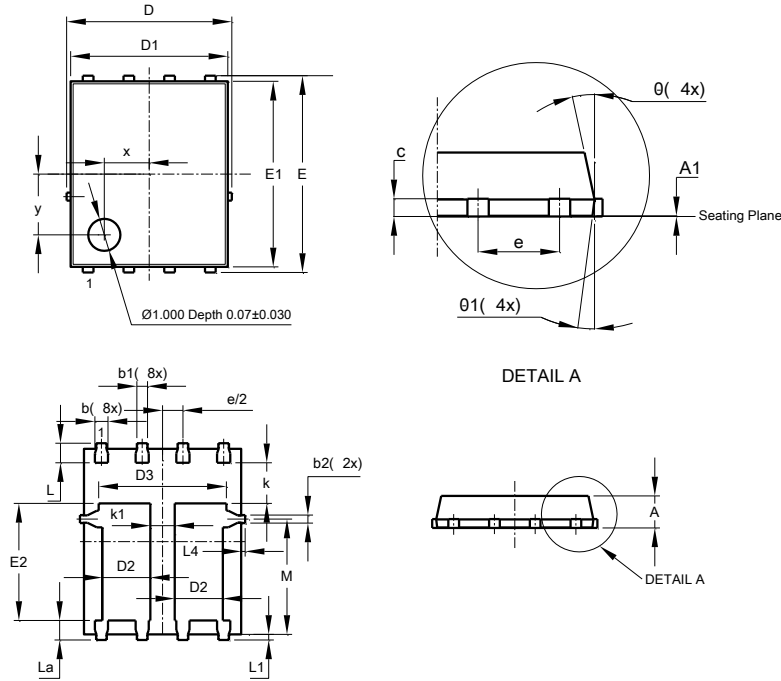

PowerDI5060-8 (Type C)			
Dim	Min	Max	Typ
A	0.90	1.10	1.00
A1	0	0.05	0.02
b	0.33	0.51	0.41
b1	0.300	0.366	0.333
b2	0.20	0.35	0.25
c	0.23	0.33	0.277
D	5.15 BSC		
D1	4.85	4.95	4.90
D2	1.40	1.60	1.50
D3	-	-	3.98
E	6.15 BSC		
E1	5.75	5.85	5.80
E2	3.56	3.76	3.66
e	1.27BSC		
k	-	-	1.27
k1	0.56	-	-
L	0.51	0.71	0.61
La	0.51	0.71	0.61
L1	0.05	0.20	0.175
L4	-	-	0.125
M	3.50	3.71	3.605
x	-	-	1.400
y	-	-	1.900
θ	10°	12°	11°
θ1	6°	8°	7°
All Dimensions in mm			

Suggested Pad Layout

Please see <http://www.diodes.com/package-outlines.html> for the latest version.

PowerDI5060-8 (Type C)

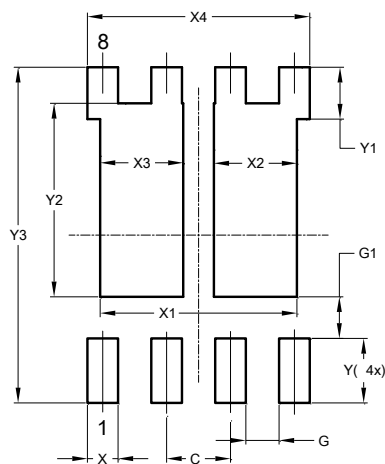

Dimensions	Value (in mm)
C	1.270
G	0.660
G1	0.820
X	0.610
X1	3.910
X2	1.650
X3	1.650
X4	4.420
Y	1.270
Y1	1.020
Y2	3.810
Y3	6.610

IMPORTANT NOTICE

DIODES INCORPORATED MAKES NO WARRANTY OF ANY KIND, EXPRESS OR IMPLIED, WITH REGARDS TO THIS DOCUMENT, INCLUDING, BUT NOT LIMITED TO, THE IMPLIED WARRANTIES OF MERCHANTABILITY AND FITNESS FOR A PARTICULAR PURPOSE (AND THEIR EQUIVALENTS UNDER THE LAWS OF ANY JURISDICTION).

Diodes Incorporated and its subsidiaries reserve the right to make modifications, enhancements, improvements, corrections or other changes without further notice to this document and any product described herein. Diodes Incorporated does not assume any liability arising out of the application or use of this document or any product described herein; neither does Diodes Incorporated convey any license under its patent or trademark rights, nor the rights of others. Any Customer or user of this document or products described herein in such applications shall assume all risks of such use and will agree to hold Diodes Incorporated and all the companies whose products are represented on Diodes Incorporated website, harmless against all damages.

Diodes Incorporated does not warrant or accept any liability whatsoever in respect of any products purchased through unauthorized sales channel. Should Customers purchase or use Diodes Incorporated products for any unintended or unauthorized application, Customers shall indemnify and hold Diodes Incorporated and its representatives harmless against all claims, damages, expenses, and attorney fees arising out of, directly or indirectly, any claim of personal injury or death associated with such unintended or unauthorized application.

Products described herein may be covered by one or more United States, international or foreign patents pending. Product names and markings noted herein may also be covered by one or more United States, international or foreign trademarks.

LIFE SUPPORT

Diodes Incorporated products are specifically not authorized for use as critical components in life support devices or systems without the express written approval of the Chief Executive Officer of Diodes Incorporated. As used herein:

A. Life support devices or systems are devices or systems which:

1. are intended to implant into the body, or
2. support or sustain life and whose failure to perform when properly used in accordance with instructions for use provided in the labeling can be reasonably expected to result in significant injury to the user.

B. A critical component is any component in a life support device or system whose failure to perform can be reasonably expected to cause the failure of the life support device or to affect its safety or effectiveness.

Customers represent that they have all necessary expertise in the safety and regulatory ramifications of their life support devices or systems, and acknowledge and agree that they are solely responsible for all legal, regulatory and safety-related requirements concerning their products and any use of Diodes Incorporated products in such safety-critical, life support devices or systems, notwithstanding any devices- or systems-related information or support that may be provided by Diodes Incorporated. Further, Customers must fully indemnify Diodes Incorporated and its representatives against any damages arising out of the use of Diodes Incorporated products in such safety-critical, life support devices or systems.

Copyright © 2016, Diodes Incorporated

www.diodes.com

Mouser Electronics

Authorized Distributor

Click to View Pricing, Inventory, Delivery & Lifecycle Information:

[Diodes Incorporated:](#)

[DMC1018UPD-13](#)