

PBS1.27-xxAS / PBS1.27-xxBS

Female Header 1.27mm, 1 Row, H=3.4mm, SMT (optional PEG, cap)

Specifications
 Current Rate: 1 AMP
 Insulation Resistance: 1000MΩ Min.
 Contact Resistance: 20mΩ Max.
 Dielectric Voltage: 500V AC for one minute
 Operation Temperature: -40°C to +105°C

Material
 Insulator: Polyester, UL 94V-0
 ©Standard: Nylon 6T
 Terminal: Copper Alloy
 Plating: Gold Plated

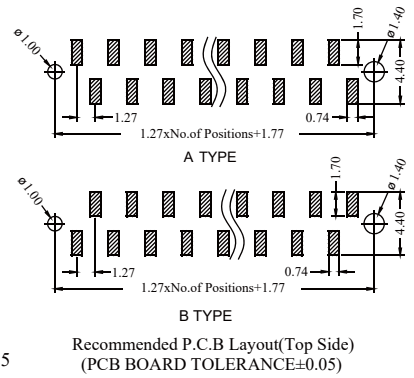
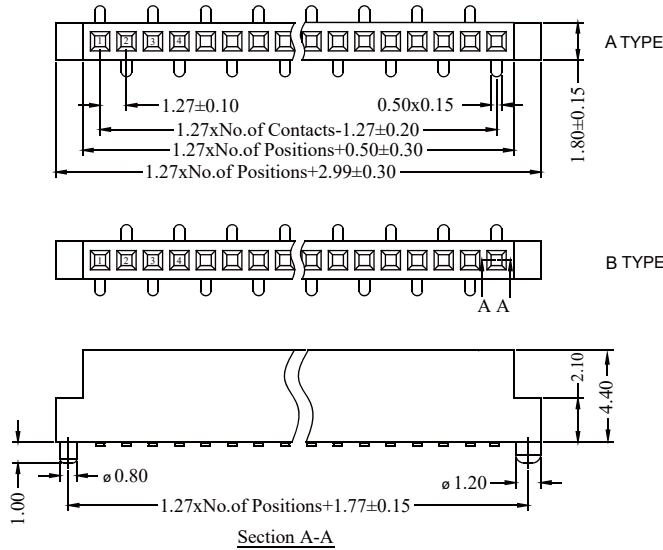
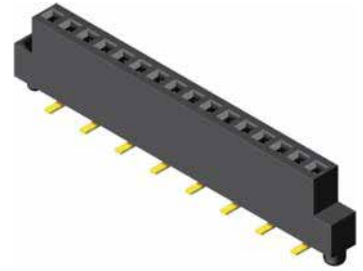

Analogue: PS3M34/44-1XX-U

PBD1.27-xxS

Female Header 1.27mm, 2 Row, H=3.4/4.4mm, SMT (optional PEG, bump, cap)

H	Dim. A
3.4	0.42x0.15
4.4	0.50x0.15

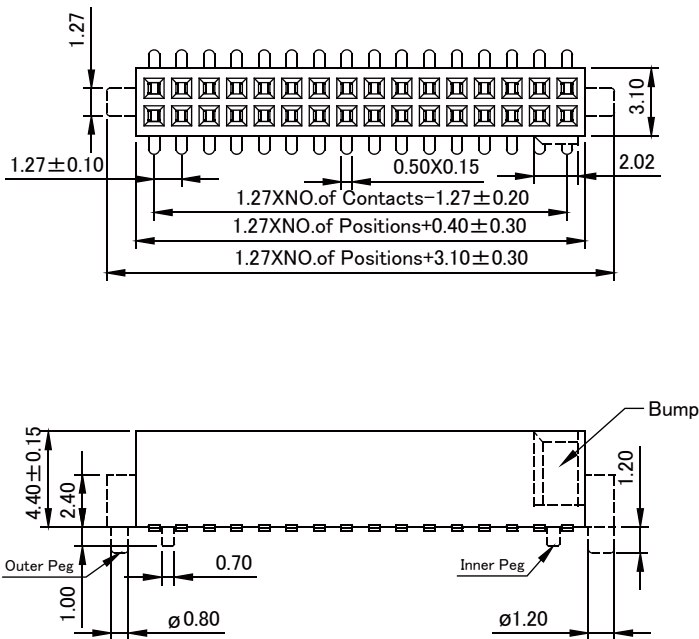
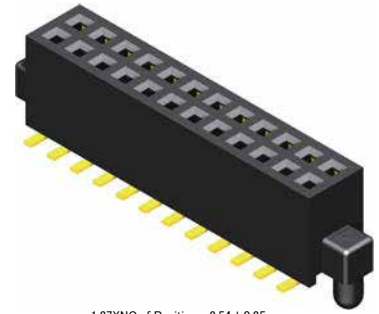

Inner Peg

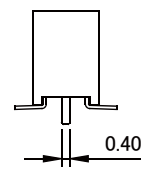

External Peg

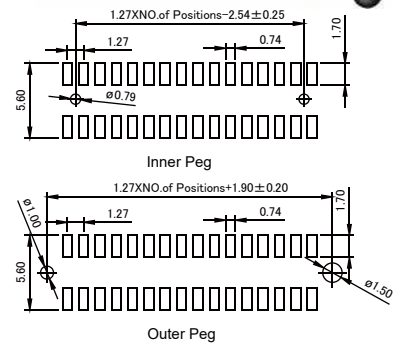
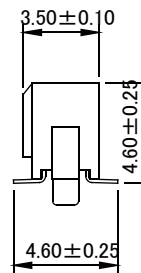

Recommended PCB Layout
(PCB TOLERANCE ±0.05)

Analogue: PS3M34/44-2XX-U