

**PVC Pre-insulated Terminal: Ring, Fork, Pin, Blade, Lipped Blade, Flag**

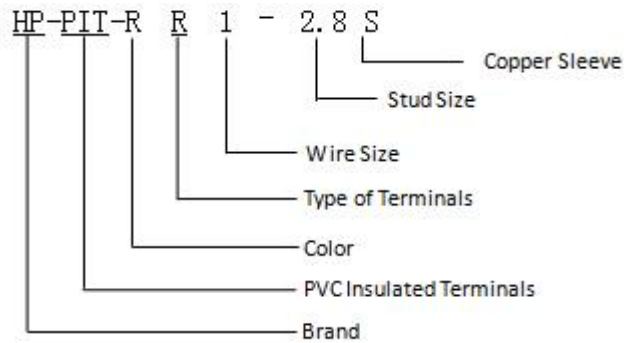

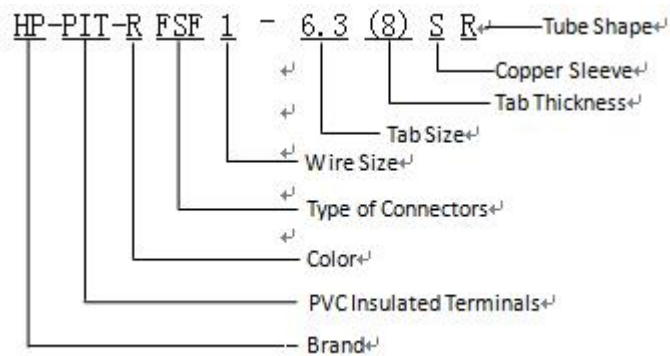



**PVC Pre-insulated Terminal: Tab, Female Spade, Bullet, Bullet Receptable**











**COLORS**

R	Red Color	B	Blue Color
Y	Yellow Color		

**TYPE OF TERMINALS/CONNECTORS**

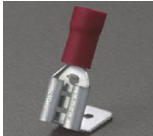
R	Ring Terminals	
F	Fork Terminals	
TAB	Tab Terminals	
FS	Female Spade Terminals	

FSF	Female Spade(fully insulated) Terminals	
BU	Bullet Terminals	
BR	Bullet Receptable Terminals	
P	Pin Terminals	
B	Blade terminals	
LB	Lipped Blade Terminals	
PB	Piggy Blade Terminals	
BCC	Butt connector(copper)	
BCB	Butt connector(brass)	

### DOUBLE CRIMP COPPER SLEEVE

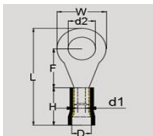
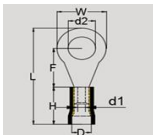
S	Straight	
SL	Long Straight	



**Hampool Enterprise Co., Limited**

















上海涵普实业有限公司

E	Easy Entry	
---	------------	-------------------------------------------------------------------------------------

Tube Shape

R	Rectangle Sleeve	
O	Oval Sleeve	

## STUD SIZE

STANDARD SIZE	STUD SIZE		HOLE SIZE	
	(Inch)	(mm)	(mm)	(Inch)
	#2	2.0	2.2	.087"
	#3	2.5	2.7	.106"
	#4	3.0	3.2	.126"
	#6	3.5	3.7	.146"
	#8	4.0	4.2	.169"
	#10	5.0	5.3	.209"
	1/4'	6.0	6.4	.252"
	5/16'	8.0	8.4	.331"
	3/8'	10.0	10.5	.413"
	7/16'	11.0	11.5	.453"
	1/2'	12.0	13.0	.512"
	9/16'	14.0	15.0	.591"
	5/8'	16.0	17.0	.669"
	11/16'	18.0	19.0	.748"
	3/4'	20.0	21.0	.827"
	7/8'	22.0	23.0	.906"
	15/16'	24.0	25.0	.984"

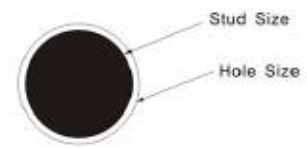

## WIRE SIZE

WIRE	WIRE RANGE	AMERICAN STANDARD(A.W.G)
1.25	0.5~1.5	22~16
2	1.5~2.5	16~14
3.5	2.5~4	14~12
5.5	4~6	12~10
8	6~10	8
14	10~16	6
22	16~25	4
38	25~35	2
60	50~70	1/O
70	70~95	2/O
80	95~120	3/O
100	120~150	4/O
150	150~185	250/300MCM
180	185~240	300/350MCM
200	240~300	400/500MCM
325	300~400	500/600MCM

## TAB SIZE

SERIES	TAB SIZE	
	(mm)	(Inch)
2.8	— 2.8×0.5	.110×.020"
	— 2.8×0.8	.110×.032"
4.8	— 4.75×0.5	.187×.020"
	— 4.75×0.8	.187×.032"
5.2	— 5.2×0.5	.205×.020"
	— 5.2×0.8	.205×.032"
6.3	— 6.35×0.8	.250×.032"
8.0	— 8.0×0.8	.312×.032"
9.4	— 9.4×1.2	.375×.047"





**Hampool Enterprise Co., Limited**

上海涵普实业有限公司

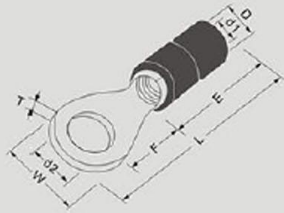

- **Material**
- Insulation: Vinyl
- Terminal Body: Copper
- Plating: Tin

## RING TERMINALS

WIRE RANGE mm <sup>2</sup> (A.W.G.)	STUD SIZE		ITEM NO.	DIMENSION mm(inch)						PACK	UL	
	mm	inch		d2	W	L	E	F	D			d1
0.5-1.5 (22-16)	3	#4	HP-PIT-RR1-3.2	3.2(.126)	5.7(.216)	17.5(.689)	10.0(.394)	4.8(.189)	4.3(.169)	1.7(.067)	10*100	✓
	3.5	#6	HP-PIT-RR1-3.7	3.7(.146)				4.8(.189)	4.3(.169)	1.7(.067)		✓
	4	#8	HP-PIT-RR1-4.3	4.3(.169)	6.6(.260)	19.4(.784)		6.3(.248)	4.3(.169)	1.7(.067)		✓
	5	#10	HP-PIT-RR1-5.3	5.3(.209)	8.0(.315)	20.8(.819)		7.0(.276)	4.3(.169)	1.7(.067)		✓
	6	1/4"	HP-PIT-RR1-6.4	6.4(.252)	11.6(.457)	26.8(1.055)		8.0(.315)	4.3(.169)	1.7(.067)		✓
	8	5/16"	HP-PIT-RR1-8.4	8.4(.331)				11.0(.433)	4.3(.169)	1.7(.067)		✓
	10	3/8"	HP-PIT-RR1-10.5	10.5(.413)	13.6(.535)	30.5(1.201)		13.9(.547)	4.3(.169)	1.7(.067)		
12	1/2"	HP-PIT-RR1-13.0	13.0(.512)	19.2(.756)	35.4(1.394)	15.0(.591)	4.3(.169)	1.7(.067)				
1.5-2.5 (16-14)	3	#4	HP-PIT-BR2-3.2	3.2(.126)	6.6(.260)	17.8(.701)	10.0(.394)	4.7(.185)	4.8(.189)	2.3(.091)	10*100	✓
	3.5	#6	HP-PIT-BR2-3.7	3.7(.146)				4.7(.185)	4.8(.189)	2.3(.091)		✓
	4	#8	HP-PIT-BR2-4.3	4.3(.169)	8.5(.335)	19.4(.784)		7.8(.307)	4.8(.189)	2.3(.091)		✓
	5	#10	HP-PIT-BR2-5.3	5.3(.209)				7.8(.307)	4.8(.189)	2.3(.091)		✓
	6	1/4"	HP-PIT-BR2-6.4	6.4(.252)	12.0(.472)	26.8(1.055)		11.0(.433)	4.8(.189)	2.3(.091)		✓
	8	5/16"	HP-PIT-BR2-8.4	8.4(.331)				11.0(.433)	4.8(.189)	2.3(.091)		✓
	10	3/8"	HP-PIT-BR2-10.5	10.5(.413)	13.6(.535)	30.5(1.201)		13.9(.547)	4.8(.189)	2.3(.091)		
12	1/2"	HP-PIT-BR2-13.0	13.0(.512)	19.2(.756)	35.4(1.394)	15.0(.591)	4.8(.189)	2.3(.091)				
4-6 (12-10)	3.5	#6	HP-PIT-YR5-3.7	3.7(.146)	7.2(.283)	22.7(.894)	13.0(.512)	6.1(.240)	6.2(.244)	3.4(.134)	10*100	✓
	4	#8	HP-PIT-YR5-4.3	4.3(.169)				6.1(.240)	6.2(.244)	3.4(.134)		✓
	5	#10	HP-PIT-YR5-5.3	5.3(.209)	9.5(.374)	26.0(1.023)		8.9(.350)	6.2(.244)	3.4(.134)		✓
	6	1/4"	HP-PIT-YR5-6.4	6.4(.252)	12.0(.472)	29.5(1.167)		9.5(.374)	6.2(.244)	3.4(.134)		✓
	8	5/16"	HP-PIT-YR5-8.4	8.4(.331)	15.0(.591)	34.0(1.339)		13.0(.512)	6.2(.244)	3.4(.134)		✓
	10	3/8"	HP-PIT-YR5-10.5	10.5(.413)				13.5(.531)	6.2(.244)	3.4(.134)		✓
	12	1/2"	HP-PIT-YR5-13.0	13.0(.512)	19.2(.758)	38.6(1.520)		15.0(.591)	6.2(.244)	3.4(.134)		✓

Not so popular size and customized size are available upon requests

WIRE RANGE mm <sup>2</sup> (A.W.G.)	STUD SIZE		ITEM NO.	DIMENSION mm(inch)						PCS/PACK	UL	
	mm	inch		d2	W	L	E	F	D			d1
0.5-1.5 (22-16)	3.5	#6	HP-PIT-RR1-3.7(6.6)	3.7(.146)	6.6(.260)	19.4(.784)	10.0(.394)	6.3(.248)	4.3(.169)	1.7(.067)	10*100	✓
	3.5	#6	HP-PIT-RR1-3.7(8)	3.7(.146)	8.0(.315)	20.8(.819)		7.0(.276)	4.3(.169)			✓
	4.0	#8	HP-PIT-RR1-4.3(8)	4.3(.169)	8.0(.315)	20.8(.819)		7.0(.276)	4.3(.169)			✓
1.5-2.5 (16-14)	3.5	#6	HP-PIT-BR2-3.7(6.6M)	3.7(.146)	6.6(.260)	17.8(.701)	10.0(.394)	6.3(.248)	4.8(.189)	2.3(.091)	10*100	
	3.5	#6	HP-PIT-BR2-3.7(8.5)	5.3(.209)	8.5(.335)	19.4(.784)		7.8(.307)	4.8(.189)			
	4.0	#8	HP-PIT-BR2-4.3(6.6)	4.3(.169)	6.6(.260)	19.4(.784)		6.3(.248)	4.8(.189)			
	5	#10	HP-PIT-BR2-5.3(9.5)	5.3(.209)	9.5(.374)	21.8(.858)		7.1(.280)	4.8(.189)		✓	
4-6 (12-10)	3	#4	HP-PIT-YR5-3.2	3.2(.126)	7.2(.283)	22.7(.894)	13.0(.512)	6.1(.240)	6.2(.244)	3.4(.134)	10*100	✓
	4	#8	HP-PIT-YR5-4.3(9.5)	4.3(.169)	9.5(.374)	26.0(1.024)		8.9(.350)	6.2(.244)			✓

Add: Floor 4, Building 12, No. 1755, Wenbei Rd., Nanxiang Town, Jiading District, Shanghai, China. P.C.:201802

Website: [www.hampool.com](http://www.hampool.com)

E-mail: [sales@hampool.com](mailto:sales@hampool.com)

[info@hampool.com](mailto:info@hampool.com)

Tel: +86-21-69927650

Fax: +86-21-69927652

Skype: [shrinkproducts](https://www.skype.com/people/shrinkproducts)



**Hampool Enterprise Co., Limited**

上海涵普实业有限公司

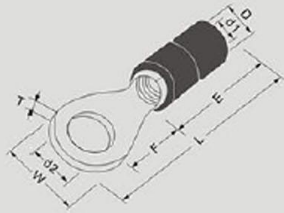

- **Material**
- Insulation: Vinyl
- Terminal Body: Copper
- Plating: Tin

## RING TERMINALS (DIN 46237)

WIRE RANGE mm <sup>2</sup> (A.W.G.)	STUD SIZE		ITEM NO.	DIMENSION mm(inch)						PACK	UL	
	mm	inch		d2	W	L	E	F	D			d1
0.5-1.5 (22-16)	3	#4	HP-PIT-DRR1-3.2	3.2(.126)	6.0(.236)	19.0(.689)	10.0(.394)	6.0(.236)	4.3(.169)	1.7(.067)	10*100	
	3.5	#6	HP-PIT-DRR1-3.7	3.7(.146)				6.0(.236)	4.3(.169)	1.7(.067)		
	4	#8	HP-PIT-DRR1-4.3	4.3(.169)	8.0(.315)	21.0(.827)		7.0(.276)	4.3(.169)	1.7(.067)		
	5	#10	HP-PIT-DRR1-5.3	5.3(.209)	10.0(.394)	23.0(.906)		8.0(.315)	4.3(.169)	1.7(.067)		
	6	1/4"	HP-PIT-DRR1-6.4	6.4(.252)	11.0(.433)	25.5(1.004)		10.0(.394)	4.3(.169)	1.7(.067)		
	8	5/16"	HP-PIT-DRR1-8.4	8.4(.331)	14.0(.551)	29.0(1.142)		12.0(.472)	4.3(.169)	1.7(.067)		
	10	3/8"	HP-PIT-DRR1-10.5	10.5(.413)	18.0(.709)	33.0(1.299)		14.0(.551)	4.3(.169)	1.7(.067)		
	12	1/2"	HP-PIT-DRR1-13.0	13.0(.512)	18.0(.709)	34.0(1.339)	15.0(.591)	4.3(.169)	1.7(.067)			
1.5-2.5 (16-14)	3	#4	HP-PIT-DBR2-3.2	3.2(.126)	6.0(.236)	19.0(.689)	10.0(.394)	6.0(.236)	4.8(.189)	2.3(.091)	10*100	
	3.5	#6	HP-PIT-DBR2-3.7	3.7(.146)				6.0(.236)	4.8(.189)	2.3(.091)		
	4	#8	HP-PIT-DBR2-4.3	4.3(.169)	8.0(.315)	21.0(.827)		7.0(.276)	4.8(.189)	2.3(.091)		
	5	#10	HP-PIT-DBR2-5.3	5.3(.209)	10.0(.394)	24.0(.945)		9.0(.354)	4.8(.189)	2.3(.091)		
	6	1/4"	HP-PIT-DBR2-6.4	6.4(.252)	11.0(.433)	26.5(1.043)		11.0(.433)	4.8(.189)	2.3(.091)		
	8	5/16"	HP-PIT-DBR2-8.4	8.4(.331)	14.0(.551)	29.0(1.142)		12.0(.472)	4.8(.189)	2.3(.091)		
	10	3/8"	HP-PIT-DBR2-10.5	10.5(.413)	18.0(.709)	33.0(1.299)		13.5(.531)	4.8(.189)	2.3(.091)		
	12	1/2"	HP-PIT-DBR2-13.0	13.0(.512)	18.0(.709)	34.0(1.339)	15.0(.591)	4.8(.189)	2.3(.091)			
4-6 (12-10)	4	#8	HP-PIT-DYR5-4.3	4.3(.169)	8.0(.315)	25.0(.984)	13.0(.512)	8.0(.315)	6.2(.244)	3.4(.134)	10*100	
	5	#10	HP-PIT-DYR5-5.3	5.3(.209)	10.0(.394)	27.0(1.063)		9.0(.354)	6.2(.244)	3.4(.134)		
	6	1/4"	HP-PIT-DYR5-6.4	6.4(.252)	11.0(.433)	28.0(1.102)		10.0(.394)	6.2(.244)	3.4(.134)		
	8	5/16"	HP-PIT-DYR5-8.4	8.4(.331)	14.0(.551)	33.0(1.299)		13.0(.512)	6.2(.244)	3.4(.134)		
	10	3/8"	HP-PIT-DYR5-10.5	10.5(.413)	18.0(.709)	37.0(1.457)		15.0(.591)	6.2(.244)	3.4(.134)		
	12	1/2"	HP-PIT-DYR5-13.0	13.0(.512)	18.0(.709)	37.0(1.457)		15.0(.591)	6.2(.244)	3.4(.134)		

Not so popular size and customized size are available upon requests

WIRE RANGE mm <sup>2</sup> (A.W.G.)	STUD SIZE		ITEM NO.	DIMENSION mm(inch)						PCS/PACK	UL	
	mm	inch		d2	W	L	E	F	D			d1
0.5-1.5 (22-16)	4	#8	HP-PIT-DRR1-4.3(7.0)	4.3(.169)	7.0(.276)	20.0(.787)	10.0(.394)	6.5(.248)	4.3(.169)	1.7(.067)	10*100	
	5	#10	HP-PIT-DRR1-5.3(8)	5.3(.209)	8.0(.315)	21.5(.846)		7.0(.276)	4.3(.169)			
1.5-2.5 (16-14)	5	#10	HP-PIT-DBR2-5.3(8)	5.3(.209)	8.0(.315)	22.5(.886)	10.0(.394)	8.5(.335)	4.8(.189)	2.3(.091)	10*100	

Add: Floor 4, Building 12, No. 1755, Wenbei Rd., Nanxiang Town, Jiading District, Shanghai, China. P.C.:201802

Website: [www.hampool.com](http://www.hampool.com)

E-mail: [sales@hampool.com](mailto:sales@hampool.com)

[info@hampool.com](mailto:info@hampool.com)

Tel: +86-21-69927650

Fax: +86-21-69927652

Skype: [shrinkproducts](https://www.skype.com/people/shrinkproducts)



**Hampool Enterprise Co., Limited**

上海涵普实业有限公司

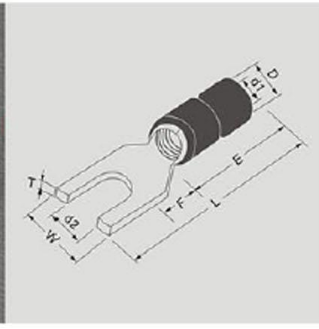

- **Material**
- Insulation: Vinyl
- Terminal Body: Copper
- Plating: Tin

## FORK TERMINALS

WIRE RANGE mm <sup>2</sup> (A.W.G.)	STUD SIZE		ITEM NO.	DIMENSION mm(inch)						PACK	UL	
	mm	inch		d2	W	L	E	F	D			d1
0.5-1.5 (22-16)	3	#4	HP-PIT-RF1-3.2	3.2(.126)	5.7(.323)	21.0(.827))	10.0(.394)	6.5(.256)	4.3(.169)	1.7(.067)	10*100	✓
	3.5	#6	HP-PIT-RF1-3.7	3.7(.146)				6.5(.256)	4.3(.169)	1.7(.067)		✓
	4	#8	HP-PIT-RF1-4.3	4.3(.169)	6.4(.252)			6.5(.256)	4.3(.169)	1.7(.067)		✓
	5	#10	HP-PIT-RF1-5.3	5.3(.209)	8.1(.319)			6.5(.256)	4.3(.169)	1.7(.067)		✓
	6	1/4"	HP-PIT-RF1-6.4	6.4(.252)	9.5(.374)			6.5(.256)	4.3(.169)	1.7(.067)		✓
1.5-2.5 (16-14)	3	#4	HP-PIT-BF2-3.2	3.2(.126)	5.7(.224)	21.0(.827)	10.0(.394)	6.5(.256)	4.8(.189)	2.3(.091)	10*100	✓
	3.5	#6	HP-PIT-BF2-3.7	3.7(.146)				6.5(.256)	4.8(.189)	2.3(.091)		✓
	4	#8	HP-PIT-BF2-4.3	4.3(.169)	6.4(.252)			6.5(.256)	4.8(.189)	2.3(.091)		✓
	5	#10	HP-PIT-BF2-5.3	5.3(.209)	7.9(.311)			6.5(.256)	4.8(.189)	2.3(.091)		✓
	6	1/4"	HP-PIT-BF2-6.4	6.4(.252)	9.3(.366)			6.5(.256)	4.8(.189)	2.3(.091)		✓
4-6 (12-10)	3.5	#6	HP-PIT-YF5-3.7	3.7(.146)	8.3(.327)	25.5(1.004)	13.0(.512)	7.0(.276))	6.2(.244)	3.4(.134)	10*100	✓
	4	#8	HP-PIT-YF5-4.3	4.3(.169)				7.0(.276))	6.2(.244)	3.4(.134)		✓
	5	#10	HP-PIT-YF5-5.3	5.3(.209)	9.0(.354)			7.0(.276))	6.2(.244)	3.4(.134)		✓
	6	1/4"	HP-PIT-YF5-6.4	6.4(.252)	12.0(.472)			12.0(.472)	6.2(.244)	3.4(.134)		✓
	8	5/16"	HP-PIT-YF5-8.4	8.4(.331)	14.0(.551)			30.5(1.201)	11.5(.453)	6.2(.244)		3.4(.134)

Not so popular size and customized size are available upon requests

WIRE RANGE mm <sup>2</sup> (A.W.G.)	STUD SIZE		ITEM NO.	DIMENSION mm(inch)						PCS/PACK	UL	
	mm	inch		d2	W	L	E	F	D			d1
0.5-1.5 (22-16)	3.5	#6	HP-PIT-RF1-3.7(6.4)	3.7(.146)	6.4(.252)	21.0(.827)	10.0(.394)	6.5(.256)	4.3(.169)	1.7(.067)	10*100	✓
	4	#8	HP-PIT-RF1-4.3(7.2)	4.3(.169)	7.2(.283)			6.5(.256)	4.3(.169)			✓
	8	5/16"	HP-PIT-RF1-8.4	8.4(.331)	12.0(.472)			27.2(1.071)	7.0(.276)			4.3(.169)
1.5-2.5 (16-14)	3.5	#6	HP-PIT-BF2-3.7(6.0)	3.7(.146)	6.0(.236)	21.0(.827)	10.0(.394)	6.5(.256)	4.8(.189)	2.3(.091)	10*100	✓
	3.5	#6	HP-PIT-BF2-3.7(7.2)	3.7(.146)	7.2(.283)			6.5(.256)	4.8(.189)			✓
	4	#8	HP-PIT-BF2-4.3(7.2)	4.3(.169)				6.5(.256)	4.8(.189)			✓
	4	#8	HP-PIT-BF2-4.3(7.9)	4.3(.169)	7.9(.311)			6.5(.256)	4.8(.189)			✓
	5	#10	HP-PIT-BF2-5.3(9.3)	5.3(.209)	9.3(.366)			6.5(.256)	4.8(.189)			✓
4-6 (12-10)	4	#8	HP-PIT-YF5-4.3(9.0)	4.3(.169)	9.0(.354)	25.5(1.004)	13.0(.512)	7.0(.276)	6.2(.244)	3.4(.134)	10*100	✓
	6	1/4"	HP-PIT-YF5-6.4(9.0)	6.4(.252)	9.0(.354)	25.5(1.004)		✓				

Add: Floor 4, Building 12, No. 1755, Wenbei Rd., Nanxiang Town, Jiading District, Shanghai, China. P.C.:201802

Website: [www.hampool.com](http://www.hampool.com)

E-mail: [sales@hampool.com](mailto:sales@hampool.com)

[info@hampool.com](mailto:info@hampool.com)

Tel: +86-21-69927650

Fax: +86-21-69927652

Skype: [shrinkproducts](https://www.skype.com/people/shrinkproducts)

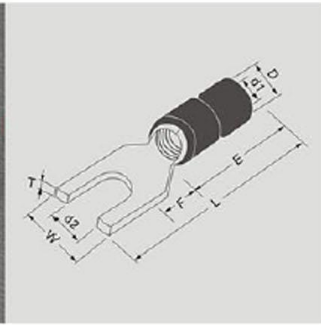

- Material
- Insulation: Vinyl
- Terminal Body: Copper
- Plating: Tin

## FORK TERMINALS (DIN 46237)

WIRE RANGE mm <sup>2</sup> (A.W.G.)	STUD SIZE		ITEM NO.	DIMENSION mm(inch)						PACK	UL	
	mm	inch		d2	W	L	E	F	D			d1
0.5-1.5 (22-16)	3	#4	HP-PIT-DRF1-3.2	3.2(.126)	6.0(.236)	18.6(.732)	10.0(.394)	6.0(.236)	4.3(.169)	1.7(.067)	10*100	
	3.5	#6	HP-PIT-DRF1-3.7	3.7(.146)				6.0(.236)	4.3(.169)	1.7(.067)		
	4	#8	HP-PIT-DRF1-4.3	4.3(.169)	8.0(.315)	20.6(.811)		7.0(.276))	4.3(.169)	1.7(.067)		
	5	#10	HP-PIT-DRF1-5.3	5.3(.209)	10.0(.394)	22.6(.890)		8.0(.315)	4.3(.169)	1.7(.067)		
	6	1/4"	HP-PIT-DRF1-6.4	6.4(.252)	11.0(.433)	25.2(.992)		10.0(.394)	4.3(.169)	1.7(.067)		
1.5-2.5 (16-14)	3	#4	HP-PIT-DBF2-3.2	3.2(.126)	5.5(.217)	18.6(.732)	10.0(.394)	8.0(.315)	4.8(.189)	2.3(.091)	10*100	
	3.5	#6	HP-PIT-DBF2-3.7	3.7(.146)	6.0(.236)			6.0(.236)	4.8(.189)	2.3(.091)		
	4	#8	HP-PIT-DBF2-4.3	4.3(.169)	8.0(.315)	20.6(.811)		7.0(.276))	4.8(.189)	2.3(.091)		
	5	#10	HP-PIT-DBF2-5.3	5.3(.209)	10.0(.394)	23.6(.929)		9.0(.354)	4.8(.189)	2.3(.091)		
	6	1/4"	HP-PIT-DBF2-6.4	6.4(.252)	11.0(.433)	26.2(1.031)		11.0(.433)	4.8(.189)	2.3(.091)		
4-6 (12-10)	4	#8	HP-PIT-DYF5-4.3	4.3(.169)	8.0(.315)	24.2(.953)	13.0(.512)	8.0(.315)	6.2(.244)	3.4(.134)	10*100	
	5	#10	HP-PIT-DYF5-5.3	5.3(.209)	10.0(.394)	26.4(1.039)		9.0(.354)	6.2(.244)	3.4(.134)		
	6	1/4"	HP-PIT-DYF5-6.4	6.4(.252)	11.0(.433)	28.2(1.110)		10.0(.394)	6.2(.244)	3.4(.134)		
	8	5/16"	HP-PIT-DYF5-8.4	8.4(.331)	14.0(.551)	32.6(1.283)		13.0(.512)	6.2(.244)	3.4(.134)		

Not so popular size and customized size are available upon requests

WIRE RANGE mm <sup>2</sup> (A.W.G.)	STUD SIZE		ITEM NO.	DIMENSION mm(inch)						PCS/PACK	UL	
	mm	inch		d2	W	L	E	F	D			d1
0.5-1.5 (22-16)	4	#8	HP-PIT-DRF1-4.3(6.8)	4.3(.169)	6.8(.268)	20.6(.811)	10.0(.394)	7.0(.276))	4.3(.169)	1.7(.067)	10*100	
1.5-2.5 (16-14)	4	#8	HP-PIT-DBF2-4.3(6.8)	4.3(.169)	6.8(.268)	20.6(.811)	10.0(.394)	7.0(.276))	4.8(.189)	2.3(.091)	10*100	
4-6 (12-10)	10	3/8"	HP-PIT-DYF5-10.5	10.5(.413)	18.0(.709)	35.6(1.402)	13.0(.512)	15.0(.591)	6.2(.244)	3.4(.134)	10*100	



**Hampool Enterprise Co., Limited**

上海涵普实业有限公司

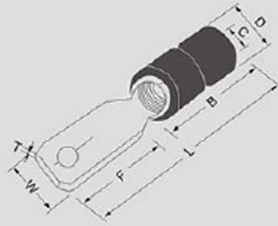

- **Material**
- Insulation: Vinyl
- Terminal Body: Brass
- Plating: Tin

## MALE TAB TERMINALS

WIRE RANGE mm <sup>2</sup> (A.W.G.)	NEMA TAB Thickness x Width	ITEM NO.	DIMENSION mm(inch)						PACK	UL
			W	L	B	F	C	D		
0.5-1.5 (22-16)	2.8x0.5 .110x.020	HP-PIT-RTAB1-2.8(5)	2.8(.110)	18.7(.736)	10.0(.394)	6.5(.256)	1.7(.067)	3.5(.138)	10*100	✓
	2.8x0.8.110x.032	HP-PIT-RTAB1-2.8(8)				6.5(.256)		3.5(.138)		✓
	4.8x0.5 .187x.020	HP-PIT-RTAB1-4.8(5)	4.8(.187)	19.3(.760)		6.7(.264)		3.5(.138)		✓
	4.8x0.8 .187x.032	HP-PIT-RTAB1-4.8(8)				6.7(.264)		3.5(.138)		✓
	6.3x0.8 .250x.032	HP-PIT-RTAB1-6.3(8)	6.35(.250)	20.8(.819)		7.7(.303)		3.5(.138)		✓
1.5-2.5 (16-14)	4.8x0.5 .187x.020	HP-PIT-BTAB2-4.8(5)	4.8(.187)	19.3(.760)	10.0(.394)	6.7(.264)	2.3(.091)	4.2(.165)	10*100	✓
	4.8x0.8 .187x.032	HP-PIT-BTAB2-4.8(8)				6.7(.264)		4.2(.165)		✓
	6.3x0.8 .250x.032	HP-PIT-BTAB2-6.3(8)	6.35(.250)	20.8(.819)		7.7(.303)		4.2(.165)		✓
4-6 (12-10)	6.3x0.8 .250x.032	HP-PIT-YTAB5-6.3(8)	6.35(.250)	24.0(.945)	13.0(.512)	7.7(.303)	3.4(.134)	5.6(.220)	10*100	✓

Not so popular size and customized Size are available according requests

WIRE RANGE mm <sup>2</sup> (A.W.G.)	NEMA TAB Thickness x Width	ITEM NO.	DIMENSION mm(inch)						PCS/PACK	UL
			W	L	B	F	C	D		
1.5-2.5 (16-14)	2.8x0.5 .110x.020	HP-PIT-BTAB2-2.8(5)	2.8(.110)	18.7(.736)	10.0(.394)	6.5(.256)	2.3(.091)	4.2(.165)	10*100	✓
	2.8x0.8.110x.032	HP-PIT-BTAB2-2.8(8)				6.5(.256)		4.2(.165)		✓

Add: Floor 4, Building 12, No. 1755, Wenbei Rd., Nanxiang Town, Jiading District, Shanghai, China. P.C.:201802

Website: [www.hampool.com](http://www.hampool.com)

E-mail: [sales@hampool.com](mailto:sales@hampool.com)

[info@hampool.com](mailto:info@hampool.com)

Tel: +86-21-69927650

Fax: +86-21-69927652

Skype: [shrinkproducts](https://www.skype.com/people/shrinkproducts)

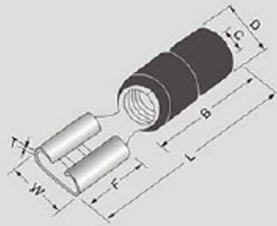
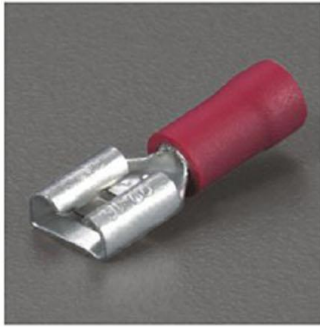

- **Material**
- Insulation: Vinyl
- Terminal Body: Brass
- Plating: Tin

## FEMALE SPADE TERMINALS

WIRE RANGE	NEMA TAB	ITEM NO.	DIMENSION mm(inch)						PACK	UL
			W	L	B	F	C	D		
0.5-1.5 (22-16)	2.8x0.5 .110x.020	HP-PIT-RFS1-2.8(5)	3.2(.126)	18.8(.740)	10.0(.394)	6.4(.252)	1.7(.067)	3.5(.138)	10*100	✓
	2.8x0.8 .110x.032	HP-PIT-RFS1-2.8(8)				6.4(.252)		3.5(.138)		✓
	4.8x0.5 .187x.020	HP-PIT-RFS1-4.8(5)	5.0(.197)	19.2(.756)		6.4(.252)		3.5(.138)		✓
	4.8x0.8 .187x.032	HP-PIT-RFS1-4.8(8)				6.4(.252)		3.5(.138)		✓
	6.3x0.8 .250x.032	HP-PIT-RFS1-6.3(8)	6.6(.260)	20.8(.819)		7.2(.283)		3.5(.138)		✓
1.5-2.5 (16-14)	2.8x0.5 .110x.020	HP-PIT-BFS2-2.8(5)	3.2(.126)	18.8(.740)	10.0(.394)	6.4(.252)	2.3(.091)	4.2(.165)	10*100	✓
	2.8x0.8 .110x.032	HP-PIT-BFS2-2.8(8)				6.4(.252)		4.2(.165)		✓
	4.8x0.5 .187x.020	HP-PIT-BFS2-4.8(5)	5.0(.197)	19.2(.756)		6.4(.252)		4.2(.165)		✓
	4.8x0.8 .187x.032	HP-PIT-BFS2-4.8(8)				6.4(.252)		4.2(.165)		✓
	6.3x0.8 .250x.032	HP-PIT-BFS2-6.3(8)	6.6(.260)	20.8(.819)		7.2(.283)		4.2(.165)		✓
8.0x0.8 .312x.032	HP-PIT-BFS2-8.0(8)	8.2(.323)	24.5(.965)	10.2(.402)	4.2(.165)					
4-6 (12-10)	6.3x0.8 .250x.032	HP-PIT-YFS5-6.3(8)	6.6(.260)	23.8(.937)	13.0(.512)	7.2(.283)	3.4(.134)	5.6(.220)	10*100	✓
	9.4x1.2.375x.047	HP-PIT-YFS5-9.4(12)	10.0(.394)	28.6(1.126)		12.0(.472)		5.6(.220)		

Not so popular size and customized Size are available according requests

WIRE RANGE	NEMA TAB	ITEM NO.	DIMENSION mm(inch)						PCS/PACK	UL
			W	L	B	F	C	D		
0.5-1.5 (22-16)	8.0x0.8 .312x.032	HP-PIT-RFS1-8.0(8)	8.2(.323)	24.5(.965)	10.0(.394)	10.0(.394)	1.7(.067)	3.5(.138)	10*100	
1.5-2.5 (16-14)	9.4x1.2.375x.047	HP-PIT-BFS2-9.4(12)	10.0(.394)	25.6(1.008)	10.0(.394)	12.0(.472)	2.3(.091)	4.2(.165)	10*100	

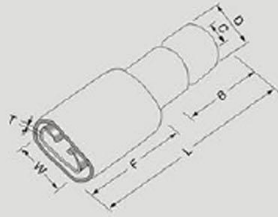

- **Material**
- Insulation: Vinyl
- Terminal Body: Brass
- Plating: Tin

## FEMALE SPADE (FULLY INSULATED) TERMINALS

WIRE RANGE mm <sup>2</sup> (A.W.G.)	NEMA TAB Thickness x Width	ITEM NO.	DIMENSION mm(inch)						PACK	UL
			W	L	B	F	C	D		
0.5-1.5 (22-16)	2.8x0.5 .110x.020	HP-PIT-RFSF1-2.8(5)O	3.2(.126)	18.8(.740)	10.0(.394)	6.4(.252)	1.7(.067)	3.3(.130)	10*100	✓
	2.8x0.8 .110x.032	HP-PIT-RFSF1-2.8(8)O				6.4(.252)		3.3(.130)		✓
	4.8x0.5 .187x.020	HP-PIT-RFSF1-4.8(5)O	5.0(.197)	19.2(.756)		6.4(.252)		3.3(.130)		✓
	4.8x0.8 .187x.032	HP-PIT-RFSF1-4.8(8)O				6.4(.252)		3.3(.130)		✓
	6.3x0.8 .250x.032	HP-PIT-RFSF1-6.3(8)O	6.6(.260)	20.8(.819)		7.2(.283)		3.3(.130)		✓
	6.3x0.8 .250x.032	HP-PIT-RFSF1-6.3(8)R				7.2(.283)		3.3(.130)		
1.5-2.5 (16-14)	2.8x0.5 .110x.020	HP-PIT-BFSF2-2.8(5)O	3.2(.126)	18.8(.740)	10.0(.394)	6.4(.252)	2.3(.091)	4.2(.165)	10*100	✓
	2.8x0.8 .110x.032	HP-PIT-BFSF2-2.8(8)O				6.4(.252)		4.2(.165)		✓
	4.8x0.5 .187x.020	HP-PIT-BFSF2-4.8(5)O	5.0(.197)	19.2(.756)		6.4(.252)		4.2(.165)		✓
	4.8x0.8 .187x.032	HP-PIT-BFSF2-4.8(8)O				6.4(.252)		4.2(.165)		✓
	6.3x0.8 .250x.032	HP-PIT-BFSF2-6.3(8)O	6.6(.260)	20.8(.819)		7.2(.283)		4.2(.165)		✓
	6.3x0.8 .250x.032	HP-PIT-BFSF2-6.3(8)R				7.2(.283)		4.2(.165)		
4-6 (12-10)	6.3x0.8 .250x.032	HP-PIT-YFSF5-6.3(8)O	6.6(.260)	23.8(.937)	13.0(.512)	7.2(.283)	3.4(.134)	5.6(.220)	10*100	✓
	9.4x1.2.375x.047	HP-PIT-YFSF5-9.4(12)O	10.0(.394)	28.6(1.126)		12.0(.472)		5.6(.220)		✓

Not so popular size and customized Size are available according requests

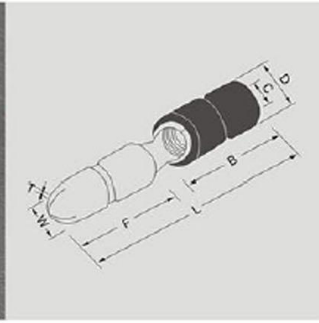

- **Material**
- Insulation: Vinyl
- Terminal Body: Brass
- Plating: Tin

## BULLET TERMINALS

WIRE RANGE mm <sup>2</sup> (A.W.G.)	ITEM NO.	DIMENSION mm(inch)						PCS/PACK	UL
		W	L	H	F	C	D		
0.5-1.5 (22-16)	HP-PIT-RBU1-4	4.0(.157)	21.0(.827)	10.0(.394)	8.5(.335)	1.7(.067)	3.5(.138)	10*100	✓
1.5-2.5 (16-14)	HP-PIT-BBU2-4	4.0(.157)	21.0(.827)	10.0(.394)	8.5(.335)	2.3(.091)	4.2(.165)	10*100	✓
	HP-PIT-BBU2-5	5.0(.197)	21.5(.846)		9.0(.354)		4.2(.165)		✓
4-6 (12-10)	HP-PIT-YBU5-5	5.0(.197)	24.5(.965)	13.0(.512)	9.0(.354)	3.4(.134)	5.6(.220)	10*100	✓

Not so popular size and customized Size are available according requests

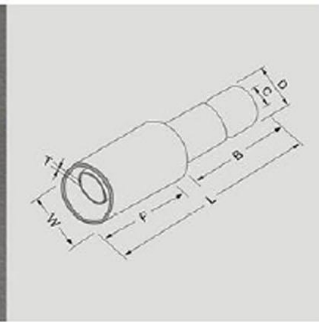

- **Material**
- Insulation: Vinyl
- Terminal Body: Brass
- Plating: Tin

## BULLET RECEPTABLE TERMINALS

WIRE RANGE mm <sup>2</sup> (A.W.G.)	ITEM NO.	DIMENSION mm(inch)						PCS/PACK	COLOR
		W	L	B	F	C	D		
0.5-1.5 (22-16)	HP-PIT-RBR1-4	4.0(.157)	23.5(.925)	10.0(.394)	7.3(.287)	1.7(.067)	3.5(.138)	10*100	✓
1.5-2.5 (16-14)	HP-PIT-BBR2-4	4.0(.157)	25.0(.984)	10.0(.394)	7.3(.287)	2.3(.091)	4.2(.165)	10*100	✓
	HP-PIT-BBR2-5	5.0(.197)			8.5(.335)		4.2(.165)		✓
4-6 (12-10)	HP-PIT-YBR5-5	5.0(.197)	28.0(1.102)	13.0(.512)	8.5(.335)	3.4(.134)	5.6(.220)	10*100	✓

Not so popular size and customized Size are available according requests



**Hampool Enterprise Co., Limited**

上海涵普实业有限公司

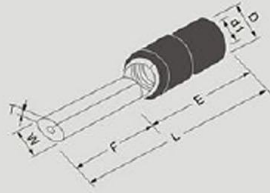

- **Material**
- Insulation: Vinyl
- Terminal Body: Copper
- Plating: Tin

## PIN TERMINALS

WIRE RANGE	ITEM NO.	DIMENSION mm(inch)						PCS/PACK	UL
		W	F	L	E	D	d1		
0.5-1.5 (22-16)	HP-PIT-RP1-9	1.9(.075)	9.0(.354)	19.0(.748)	10.0(.394)	4.3(.169)	1.7(.067)	10*100	
	HP-PIT-RP1-10		10.0(.394)	20.0(.787)					
	HP-PIT-RP1-12		12.0(.472)	22.0(.866)					
1.5-2.5 (16-14)	HP-PIT-BP2-9	1.9(.075)	9.0(.354)	19.0(.748)	10.0(.394)	4.8(.189)	2.3(.091)	10*100	
	HP-PIT-BP2-10		10.0(.394)	20.0(.787)					
	HP-PIT-BP2-12		12.0(.472)	22.0(.866)					
4-6 (12-10)	HP-PIT-YP5-13	2.8(.110)	14.0(.551)	27.0(1.063)	13.0(.512)	6.2(.244)	3.4(.134)	10*100	

Not so popular size and customized Size are available according requests

WIRE RANGE	ITEM NO.	DIMENSION mm(inch)						PCS/PACK	UL
		W	F	L	E	D	d1		
0.5-1.5 (22-16)	HP-PIT-RP1-13	1.9(.075)	13.0(.512)	23.0(.906)	10.0(.394)	4.3(.169)	1.7(.067)	10*100	
1.5-2.5 (16-14)	HP-PIT-BP2-13	1.9(.075)	13.0(.512)	23.0(.906)	10.0(.394)	4.8(.189)	2.3(.091)	10*100	

Add: Floor 4, Building 12, No. 1755, Wenbei Rd., Nanxiang Town, Jiading District, Shanghai, China. P.C.:201802

Website: [www.hampool.com](http://www.hampool.com)

E-mail: [sales@hampool.com](mailto:sales@hampool.com)

[info@hampool.com](mailto:info@hampool.com)

Tel: +86-21-69927650

Fax: +86-21-69927652

Skype: shrinkproducts



**Hampool Enterprise Co., Limited**

上海涵普实业有限公司

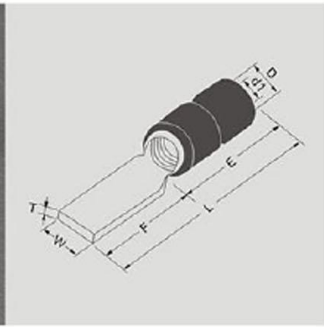

- **Material**
- **Insulation:** Vinyl
- **Terminal Body:** Copper
- **Plating:** Tin

## BLADE TERMINALS

WIRE RANGE mm <sup>2</sup> (A.W.G.)	ITEM NO.	DIMENSION mm(inch)						PCS/PACK	UL
		W	F	L	E	D	d1		
0.5-1.5 (22-16)	HP-PIT-RB1-2310	2.3(.091)	10.0(.394)	20.0(.787)	10.0(.394)	4.3(.169)	1.7(.067)	10*100	
	HP-PIT-RB1-3011	3.0(.118)	11.0(.433)	21.0(.827)					
	HP-PIT-RB1-3014		14.0(.551)	24.0(.945)					
	HP-PIT-RB1-2218	2.2(.087)	18.0(.709)	28.0(1.102)					
1.5-2.5 (16-14)	HP-PIT-BB2-2809	2.8(.110)	9.0(.354)	19.0(.748)	10.0(.394)	4.8(.189)	2.3(.091)	10*100	
	HP-PIT-BB2-2410	2.4(.094)	10.0(.394)	20.0(.787)					
	HP-PIT-BB2-2413		13.0(.512)	23.0(.906)					
	HP-PIT-BB2-2218	2.2(.079)	18.0(.709)	28.0(1.102)					
4-6 (12-10)	HP-PIT-YB5-2810	2.8(.110)	10.0(.394)	23.0(.906)	13.0(.512)	6.2(.244)	3.4(.134)	10*100	
	HP-PIT-YB5-4518	4.5(.177)	18.0(.709)	31.0(1.220)					

Not so popular size and customized Size are available according requests

WIRE RANGE mm <sup>2</sup> (A.W.G.)	ITEM NO.	DIMENSION mm(inch)						PCS/PACK	UL
		W	F	L	E	D	d1		
0.5-1.5 (22-16)	HP-PIT-RB1-2809	2.8(.110)	9.0(.354)	19.0(.748)	10.0(.394)	4.3(.169)	1.7(.067)	10*100	
	HP-PIT-RB1-2018	2.0(.079)	18.0(.709)	28.0(1.102)					

Add: Floor 4, Building 12, No. 1755, Wenbei Rd., Nanxiang Town, Jiading District, Shanghai, China. P.C.:201802

Website: [www.hampool.com](http://www.hampool.com)

E-mail: [sales@hampool.com](mailto:sales@hampool.com)

[info@hampool.com](mailto:info@hampool.com)

Tel: +86-21-69927650

Fax: +86-21-69927652

Skype: [shrinkproducts](https://www.skype.com/people/shrinkproducts)

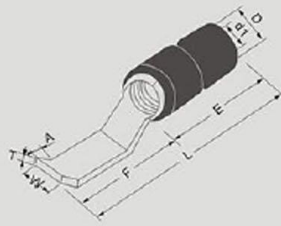

- **Material**
- Insulation: Vinyl
- Terminal Body: Copper
- Plating: Tin

## LIPPED BLADE TERMINALS

WIRE RANGE mm <sup>2</sup> (A.W.G.)	ITEM NO.	DIMENSION mm(inch)							PCS/PACK	COLOR
		W	L	E	F	A	D	d1		
0.5-1.5 (22-16)	HP-PIT-RLB1-3	3.0(.118)	25.6(1.008)	10.0(.394)	15.6(.614)	2.1(.083)	4.3(.169)	1.7(.067)	10*100	
	HP-PIT-RLB1-4.6	4.6(.181)								
1.5-2.5 (16-14)	HP-PIT-BLB2-3	3.0(.118)	25.6(1.008)	10.0(.394)	15.6(.614)	2.1(.083)	4.8(.189)	2.3(.091)	10*100	
	HP-PIT-BLB2-4.6	4.6(.181)								
4-6 (12-10)	HP-PIT-YLB5-4.6	4.6(.181)	30.2(1.189)	13.0(.512)	17.2(.677)	2.4(.094)	6.2(.244)	3.4(.134)	10*100	

Not so popular size and customized Size are available according requests

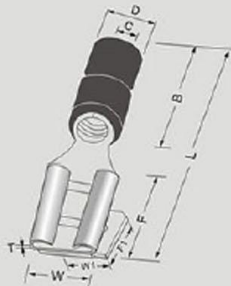
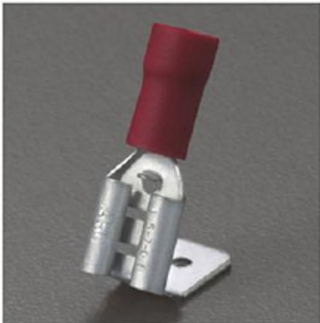

- **Material**
- Insulation: Vinyl
- Terminal Body: Brass
- Plating: Tin

## PIGGY BACK TERMINALS

WIRE RANGE mm <sup>2</sup> (A.W.G.)	NEMA TAB Thickness x Width	ITEM NO.	DIMENSION mm(inch)								PACK	UL
			W	W1	L	F	F1	B	D	d1		
0.5-1.5 (22-16)	6.3x0.8 .250x.032	HP-PIT-RPB1-6.3	6.6(.260)	6.35(.250)	22.0(.866)	8.0(.315)	8.2(.323)	10.0(.394)	3.5(138)	1.7(.067)	10*100	√
1.5-2.5 (16-14)	6.3x0.8 .250x.032	HP-PIT-BPB2-6.3	6.6(.260)	6.35(.250)	22.0(.866)	8.0(.315)	8.2(.323)	10.0(.394)	4.2(.165)	2.3(.091)	10*100	√
4-6 (12-10)	6.3x0.8 .250x.032	HP-PIT-YPB5-6.3	6.6(.260)	6.35(.250)	24.5(.965)	8.0(.315)	8.2(.323)	13.0(.512)	5.6(.220)	3.4(.134)	10*100	√

Not so popular size and customized Size are available according requests

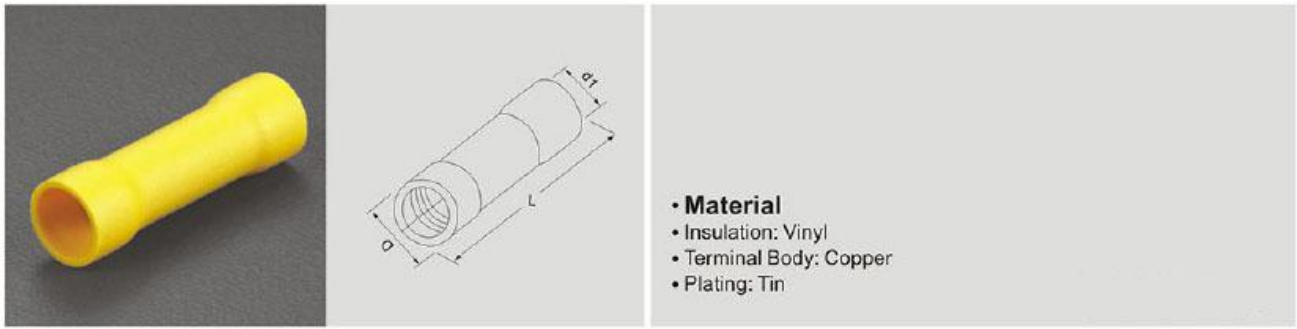

## BUTT CONNECTOR TERMINALS(COPPER)

WIRE RANGE mm2 (A.W.G.)	ITEM NO.	DIMENSION mm(inch)			PACK	UL
		L	D	d1		
0.5-1.5 (22-16)	HP-PIT-RBCC1	24.5	4.3(.169)	1.7(.067)	10*100	✓
1.5-2.5 (16-14)	HP-PIT-BBCC2	24.5	4.8(.189)	2.3(.091)	10*100	✓
4-6 (12-10)	HP-PIT-YBCC5	27	6.2(.244)	3.4(.134)	10*100	✓

Not so popular size and customized Size are available according requests

WIRE RANGE mm2 (A.W.G.)	ITEM NO.	DIMENSION mm(inch)			PACK	UL
		L	D	d1		
8 (8)	HP-PIT-RBCC8	35.5	8.5(.335)	4.5(.177)	10*100	✓

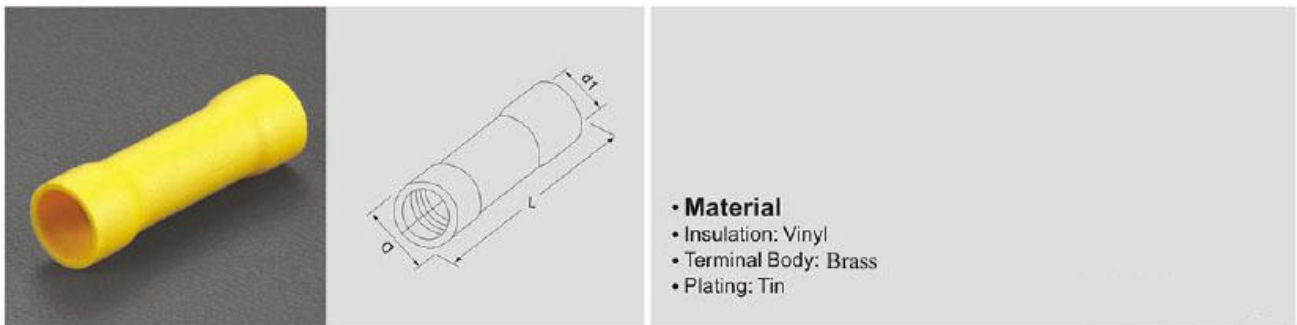

## BUTT CONNECTOR TERMINALS(BRASS)

WIRE RANGE mm2 (A.W.G.)	ITEM NO.	DIMENSION mm(inch)			PCS/PACK	UL
		L	D	d1		
0.5-1.5 (22-16)	HP-PIT-RBCB1	24.5	4.3(.169)	1.7(.067)	10*100	
1.5-2.5 (16-14)	HP-PIT-BBCB2	24.5	4.8(.189)	2.3(.091)	10*100	
4-6 (12-10)	HP-PIT-YBCB5	27	6.2(.244)	3.4(.134)	10*100	

Not so popular size and customized Size are available according requests

## Double Crimp Straight Sleeve

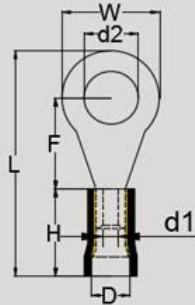

- **Material**
- Insulation: Vinyl
- Terminal Body: Copper
- Metallic Sleeve: Copper
- Plating: Tin
- **Character:**
- Straight
- Better Conduct Connection

## RING TERMINALS

WIRE RANGE mm <sup>2</sup> (A.W.G.)	STUD SIZE		ITEM NO.	DIMENSION mm(inch)						PACK	UL
	mm	inch		d2	W	L	H	F	D		
0.5-1.5 (22-16)	3	#4	HP-PIT-RR1-3.2S	3.2(.126)	5.7(.216)	17.5(.689)	10.0(.394)	4.8(.189)	4.3(.169)	1.7(.067)	10*100
	3.5	#6	HP-PIT-RR1-3.7S	3.7(.146)				4.8(.189)	4.3(.169)	1.7(.067)	
	4	#8	HP-PIT-RR1-4.3S	4.3(.169)	6.6(.260)	19.4(.784)		6.3(.248)	4.3(.169)	1.7(.067)	
	5	#10	HP-PIT-RR1-5.3S	5.3(.209)	8.0(.315)	20.8(.819)		7.0(.276)	4.3(.169)	1.7(.067)	
	6	1/4"	HP-PIT-RR1-6.4S	6.4(.252)	11.6(.457)	26.8(1.055)		8.0(.315)	4.3(.169)	1.7(.067)	
	8	5/16"	HP-PIT-RR1-8.4S	8.4(.331)				11.0(.433)	4.3(.169)	1.7(.067)	
	10	3/8"	HP-PIT-RR1-10.5S	10.5(.413)	13.6(.535)	30.5(1.201)		13.9(.547)	4.3(.169)	1.7(.067)	
12	1/2"	HP-PIT-RR1-13.0S	13.0(.512)	19.2(.756)	35.4(1.394)	15.0(.591)	4.3(.169)	1.7(.067)			
1.5-2.5 (16-14)	3	#4	HP-PIT-BR2-3.2S	3.2(.126)	6.6(.260)	17.8(.701)	10.0(.394)	4.7(.185)	5.0(.197)	2.3(.091)	10*100
	3.5	#6	HP-PIT-BR2-3.7S	3.7(.146)				4.7(.185)	5.0(.197)	2.3(.091)	
	4	#8	HP-PIT-BR2-4.3S	4.3(.169)	8.5(.335)	19.4(.784)		7.8(.307)	5.0(.197)	2.3(.091)	
	5	#10	HP-PIT-BR2-5.3S	5.3(.209)				7.8(.307)	5.0(.197)	2.3(.091)	
	6	1/4"	HP-PIT-BR2-6.4S	6.4(.252)	12.0(.472)	26.8(1.055)		11.0(.433)	5.0(.197)	2.3(.091)	
	8	5/16"	HP-PIT-BR2-8.4S	8.4(.331)				11.0(.433)	5.0(.197)	2.3(.091)	
	10	3/8"	HP-PIT-BR2-10.5S	10.5(.413)	13.6(.535)	30.5(1.201)		13.9(.547)	5.0(.197)	2.3(.091)	
12	1/2"	HP-PIT-BR2-13.0S	13.0(.512)	19.2(.756)	35.4(1.394)	15.0(.591)	5.0(.197)	2.3(.091)			
4-6 (12-10)	3.5	#6	HP-PIT-YR5-3.7S	3.7(.146)	7.2(.283)	22.7(.894)	13.0(.512)	6.1(.240)	6.7(.264)	3.4(.134)	10*100
	4	#8	HP-PIT-YR5-4.3S	4.3(.169)				6.1(.240)	6.7(.264)	3.4(.134)	
	5	#10	HP-PIT-YR5-5.3S	5.3(.209)	9.5(.374)	26.0(1.023)		8.9(.350)	6.7(.264)	3.4(.134)	
	6	1/4"	HP-PIT-YR5-6.4S	6.4(.252)	12.0(.472)	29.5(1.167)		9.5(.374)	6.7(.264)	3.4(.134)	
	8	5/16"	HP-PIT-YR5-8.4S	8.4(.331)				13.0(.512)	6.7(.264)	3.4(.134)	
	10	3/8"	HP-PIT-YR5-10.5S	10.5(.413)	15.0(.591)	34.0(1.339)		13.5(.531)	6.7(.264)	3.4(.134)	
	12	1/2"	HP-PIT-YR5-13.0S	13.0(.512)	19.2(.758)	38.6(1.520)		15.0(.591)	6.7(.264)	3.4(.134)	

Not so popular size and customized size are available upon requests

WIRE RANGE mm <sup>2</sup> (A.W.G.)	STUD SIZE		ITEM NO.	DIMENSION mm(inch)						PCS/PAC K	UL
	mm	inch		d2	W	L	H	F	D		
0.5-1.5 (22-16)	3.5	#6	HP-PIT-RR1-3.7(6.6)S	3.7(.146)	6.6(.260)	19.4(.784)	10.0(.394)	6.3(.248)	4.3(.169)	1.7(.067)	10*100
	3.5	#6	HP-PIT-RR1-3.7(8)S	3.7(.146)	8.0(.315)	20.8(.819)		7.0(.276)	4.3(.169)		
	4.0	#8	HP-PIT-RR1-4.3(8)S	4.3(.169)	8.0(.315)	20.8(.819)		7.0(.276)	4.3(.169)		
1.5-2.5 (16-14)	3.5	#6	HP-PIT-BR2-3.7(6.6)S	3.7(.146)	6.6(.260)	17.8(.701)	10.0(.394)	6.3(.248)	5.0(.197)	2.3(.091)	10*100
	3.5	#6	HP-PIT-BR2-3.7(8.5)S	5.3(.209)	8.5(.335)	19.4(.784)		7.8(.307)	5.0(.197)		
	4.0	#8	HP-PIT-BR2-4.3(6.6)S	4.3(.169)	6.6(.260)	19.4(.784)		6.3(.248)	5.0(.197)		
4-6 (12-10)	3	#4	HP-PIT-YR5-3.2S	3.2(.126)	7.2(.283)	22.7(.894)	13.0(.512)	6.1(.240)	6.7(.264)	3.4(.134)	10*100
	4	#8	HP-PIT-YR5-4.3(9.5)S	4.3(.169)	9.5(.374)	26.0(1.024)		8.9(.350)	6.7(.264)		

Add: Floor 4, Building 12, No. 1755, Wenbei Rd., Nanxiang Town, Jiading District, Shanghai, China. P.C.:201802

Website: [www.hampool.com](http://www.hampool.com)

E-mail: [sales@hampool.com](mailto:sales@hampool.com)

[info@hampool.com](mailto:info@hampool.com)

Tel: +86-21-69927650

Fax: +86-21-69927652

Skype: [shrinkproducts](https://www.skype.com/people/shrinkproducts)

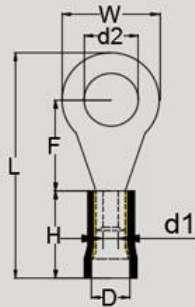

- **Material**
- Insulation: Vinyl
- Terminal Body: Copper
- Metallic Sleeve: Copper
- Plating: Tin
- **Character:**
- Straight
- Better Conduct Connection

## RING TERMINALS (DIN 46237)

WIRE RANGE mm <sup>2</sup> (A.W.G.)	STUD SIZE		ITEM NO.	DIMENSION mm(inch)						PACK	UL	
	mm	inch		d2	W	L	H	F	D			d1
0.5-1.5 (22-16)	3	#4	HP-PIT-DRR1-3.2S	3.2(.126)	6.0(.236)	19.0(.689)	10.0(.394)	6.0(.236)	4.3(.169)	1.7(.067)	10*100	
	3.5	#6	HP-PIT-DRR1-3.7S	3.7(.146)				6.0(.236)	4.3(.169)	1.7(.067)		
	4	#8	HP-PIT-DRR1-4.3S	4.3(.169)	8.0(.315)	21.0(.827)		7.0(.276)	4.3(.169)	1.7(.067)		
	5	#10	HP-PIT-DRR1-5.3S	5.3(.209)	10.0(.394)	23.0(.906)		8.0(.315)	4.3(.169)	1.7(.067)		
	6	1/4"	HP-PIT-DRR1-6.4S	6.4(.252)	11.0(.433)	25.5(1.004)		10.0(.394)	4.3(.169)	1.7(.067)		
	8	5/16"	HP-PIT-DRR1-8.4S	8.4(.331)	14.0(.551)	29.0(1.142)		12.0(.472)	4.3(.169)	1.7(.067)		
	10	3/8"	HP-PIT-DRR1-10.5S	10.5(.413)	18.0(.709)	33.0(1.299)		14.0(.551)	4.3(.169)	1.7(.067)		
	12	1/2"	HP-PIT-DRR1-13.0S	13.0(.512)	18.0(.709)	34.0(1.339)	15.0(.591)	4.3(.169)	1.7(.067)			
1.5-2.5 (16-14)	3	#4	HP-PIT-DBR2-3.2S	3.2(.126)	6.0(.236)	19.0(.689)	10.0(.394)	6.0(.236)	5.0(.197)	2.3(.091)	10*100	
	3.5	#6	HP-PIT-DBR2-3.7S	3.7(.146)				6.0(.236)	5.0(.197)	2.3(.091)		
	4	#8	HP-PIT-DBR2-4.3S	4.3(.169)	8.0(.315)	21.0(.827)		7.0(.276)	5.0(.197)	2.3(.091)		
	5	#10	HP-PIT-DBR2-5.3S	5.3(.209)	10.0(.394)	24.0(.945)		9.0(.354)	5.0(.197)	2.3(.091)		
	6	1/4"	HP-PIT-DBR2-6.4S	6.4(.252)	11.0(.433)	26.5(1.043)		11.0(.433)	5.0(.197)	2.3(.091)		
	8	5/16"	HP-PIT-DBR2-8.4S	8.4(.331)	14.0(.551)	29.0(1.142)		12.0(.472)	5.0(.197)	2.3(.091)		
	10	3/8"	HP-PIT-DBR2-10.5S	10.5(.413)	18.0(.709)	33.0(1.299)		13.5(.531)	5.0(.197)	2.3(.091)		
	12	1/2"	HP-PIT-DBR2-13.0S	13.0(.512)	18.0(.709)	34.0(1.339)	15.0(.591)	5.0(.197)	2.3(.091)			
4-6 (12-10)	4	#8	HP-PIT-DYR5-4.3S	4.3(.169)	8.0(.315)	25.0(.984)	13.0(.512)	8.0(.315)	6.7(.264)	3.4(.134)	10*100	
	5	#10	HP-PIT-DYR5-5.3S	5.3(.209)	10.0(.394)	27.0(1.063)		9.0(.354)	6.7(.264)	3.4(.134)		
	6	1/4"	HP-PIT-DYR5-6.4S	6.4(.252)	11.0(.433)	28.0(1.102)		10.0(.394)	6.7(.264)	3.4(.134)		
	8	5/16"	HP-PIT-DYR5-8.4S	8.4(.331)	14.0(.551)	33.0(1.299)		13.0(.512)	6.7(.264)	3.4(.134)		
	10	3/8"	HP-PIT-DYR5-10.5S	10.5(.413)	18.0(.709)	37.0(1.457)		15.0(.591)	6.7(.264)	3.4(.134)		
	12	1/2"	HP-PIT-DYR5-13.0S	13.0(.512)	18.0(.709)	37.0(1.457)		15.0(.591)	6.7(.264)	3.4(.134)		

Not so popular size and customized size are available upon requests

WIRE RANGE mm <sup>2</sup> (A.W.G.)	STUD SIZE		ITEM NO.	DIMENSION mm(inch)						PCS/PACK	UL	
	mm	inch		d2	W	L	H	F	D			d1
0.5-1.5 (22-16)	4	#8	HP-PIT-DRR1-4.3(7.0)S	4.3(.169)	7.0(.276)	20.0(.787)	10.0(.394)	6.5(.248)	4.3(.169)	1.7(.067)	10*100	
	5	#10	HP-PIT-DRR1-5.3(8)S	5.3(.209)	8.0(.315)	21.5(.846)		7.0(.276)	4.3(.169)			
1.5-2.5 (16-14)	5	#10	HP-PIT-DBR2-5.3(8)S	5.3(.209)	8.0(.315)	22.5(.886)	10.0(.394)	8.5(.335)	5.0(.197)	2.3(.091)	10*100	



**Hampool Enterprise Co., Limited**

上海涵普实业有限公司

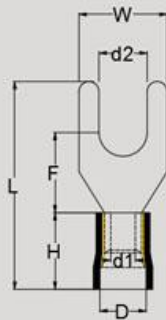

- **Material**
- Insulation: Vinyl
- Terminal Body: Copper
- Metallic Sleeve: Copper
- Plating: Tin
- **Character:**
- Straight
- Better Conduct Connection

## FORK TERMINALS

WIRE RANGE mm <sup>2</sup> (A.W.G.)	STUD SIZE		ITEM NO.	DIMENSION mm(inch)							PACK	UL
	mm	inch		d2	W	L	H	F	D	d1		
0.5-1.5 (22-16)	3	#4	HP-PIT-RF1-3.2S	3.2(.126)	5.7(.323)	21.0(.827)	10.0(.394)	6.5(.256)	4.3(.169)	1.7(.067)	10*100	
	3.5	#6	HP-PIT-RF1-3.7S	3.7(.146)				6.5(.256)	4.3(.169)	1.7(.067)		
	4	#8	HP-PIT-RF1-4.3S	4.3(.169)	6.4(.252)			6.5(.256)	4.3(.169)	1.7(.067)		
	5	#10	HP-PIT-RF1-5.3S	5.3(.209)	8.1(.319)			6.5(.256)	4.3(.169)	1.7(.067)		
1.5-2.5 (16-14)	6	1/4"	HP-PIT-RF1-6.4S	6.4(.252)	9.5(.374)			6.5(.256)	4.3(.169)	1.7(.067)		
	3	#4	HP-PIT-BF2-3.2S	3.2(.126)	5.7(.224)	21.0(.827)	10.0(.394)	6.5(.256)	5.0(.197)	2.3(.091)	10*100	
	3.5	#6	HP-PIT-BF2-3.7S	3.7(.146)				6.5(.256)	5.0(.197)	2.3(.091)		
	4	#8	HP-PIT-BF2-4.3S	4.3(.169)	6.4(.252)			6.5(.256)	5.0(.197)	2.3(.091)		
5	#10	HP-PIT-BF2-5.3S	5.3(.209)	8.1(.319)	6.5(.256)			5.0(.197)	2.3(.091)			
4-6 (12-10)	6	1/4"	HP-PIT-BF2-6.4S	6.4(.252)	9.3(.366)			6.5(.256)	5.0(.197)	2.3(.091)		
	3.5	#6	HP-PIT-YF5-3.7S	3.7(.146)	8.3(.327)	25.5(1.004)	13.0(.512)	7.0(.276))	6.7(.264)	3.4(.134)	10*100	
	4	#8	HP-PIT-YF5-4.3S	4.3(.169)				7.0(.276))	6.7(.264)	3.4(.134)		
	5	#10	HP-PIT-YF5-5.3S	5.3(.209)	9.0(.354)			7.0(.276))	6.7(.264)	3.4(.134)		
6	1/4"	HP-PIT-YF5-6.4S	6.4(.252)	12.0(.472)	12.0(.472)			6.7(.264)	3.4(.134)			
	8	5/16"	HP-PIT-YF5-8.4S	8.4(.331)	14.0(.551)	30.5(1.201)		11.5(.453)	6.7(.264)	3.4(.134)		

Not so popular size and customized size are available upon requests

WIRE RANGE mm <sup>2</sup> (A.W.G.)	STUD SIZE		ITEM NO.	DIMENSION mm(inch)							PCS/PAC K	UL
	mm	inch		d2	W	L	H	F	D	d1		
0.5-1.5 (22-16)	3.5	#6	HP-PIT-RF1-3.7(6.4)S	3.7(.146)	6.4(.252)	21.0(.827)	10.0(.394)	6.5(.256)	4.3(.169)	1.7(.067)	10*100	
	4	#8	HP-PIT-RF1-4.3(7.2)S	4.3(.169)	7.2(.283)			6.5(.256)	4.3(.169)			
	8	5/16"	HP-PIT-RF1-8.4S	8.4(.331)	12.0(.472)	27.2(1.071)		7.0(.276)	4.3(.169)			
1.5-2.5 (16-14)	3.5	#6	HP-PIT-BF2-3.7(6.0)S	3.7(.146)	6.0(.236)	21.0(.827)	10.0(.394)	6.5(.256)	5.0(.197)	2.3(.091)	10*100	
	3.5	#6	HP-PIT-BF2-3.7(7.2)S	3.7(.146)	7.2(.283)			6.5(.256)	5.0(.197)			
	4	#8	HP-PIT-BF2-4.3(7.2)S	4.3(.169)				6.5(.256)	5.0(.197)			
	4	#8	HP-PIT-BF2-4.3(7.9)S	4.3(.169)	7.9(.311)			6.5(.256)	5.0(.197)			
	5	#10	HP-PIT-BF2-5.3(9.3)S	5.3(.209)	9.3(.366)			6.5(.256)	5.0(.197)			
4-6 (12-10)	4	#8	HP-PIT-YF5-4.3(9.0)S	4.3(.169)	9.0(.354)	25.5(1.004)	13.0(.512)	7.0(.276)	6.7(.264)	3.4(.134)	10*100	

Add: Floor 4, Building 12, No. 1755, Wenbei Rd., Nanxiang Town, Jiading District, Shanghai, China. P.C.:201802

Website: [www.hampool.com](http://www.hampool.com)

E-mail: [sales@hampool.com](mailto:sales@hampool.com)

[info@hampool.com](mailto:info@hampool.com)

Tel: +86-21-69927650

Fax: +86-21-69927652

Skype: [shrinkproducts](https://www.skype.com/people/shrinkproducts)



**Hampool Enterprise Co., Limited**

上海涵普实业有限公司

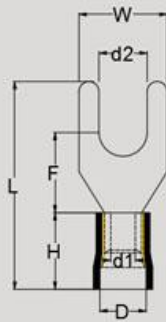

- **Material**
  - Insulation: Vinyl
  - Terminal Body: Copper
  - Metallic Sleeve: Copper
  - Plating: Tin
- **Character:**
  - Straight
  - Better Conduct Connection

## FORK TERMINALS (DIN 46237)

WIRE RANGE mm <sup>2</sup> (A.W.G.)	STUD SIZE		ITEM NO.	DIMENSION mm(inch)							PACK	UL
	mm	inch		d2	W	L	H	F	D	d1		
0.5-1.5 (22-16)	3	#4	HP-PIT-DRF1-3.2S	3.2(.126)	6.0(.236)	18.6(.732)	10.0(.394)	6.0(.236)	4.3(.169)	1.7(.067)	10*100	
	3.5	#6	HP-PIT-DRF1-3.7S	3.7(.146)				6.0(.236)	4.3(.169)	1.7(.067)		
	4	#8	HP-PIT-DRF1-4.3S	4.3(.169)	8.0(.315)	20.6(.811)		7.0(.276))	4.3(.169)	1.7(.067)		
	5	#10	HP-PIT-DRF1-5.3S	5.3(.209)	10.0(.394)	22.6(.890)		8.0(.315)	4.3(.169)	1.7(.067)		
	6	1/4"	HP-PIT-DRF1-6.4S	6.4(.252)	11.0(.433)	25.2(.992)		10.0(.394)	4.3(.169)	1.7(.067)		
1.5-2.5 (16-14)	3	#4	HP-PIT-DBF2-3.2S	3.2(.126)	5.5(.217)	18.6(.732)	10.0(.394)	8.0(.315)	5.0(.197)	2.3(.091)	10*100	
	3.5	#6	HP-PIT-DBF2-3.7S	3.7(.146)	6.0(.236)			6.0(.236)	5.0(.197)	2.3(.091)		
	4	#8	HP-PIT-DBF2-4.3S	4.3(.169)	8.0(.315)	20.6(.811)		7.0(.276))	5.0(.197)	2.3(.091)		
	5	#10	HP-PIT-DBF2-5.3S	5.3(.209)	10.0(.394)	23.6(.929)		9.0(.354)	5.0(.197)	2.3(.091)		
	6	1/4"	HP-PIT-DBF2-6.4S	6.4(.252)	11.0(.433)	26.2(1.031)		11.0(.433)	5.0(.197)	2.3(.091)		
4-6 (12-10)	4	#8	HP-PIT-DYF5-4.3S	4.3(.169)	8.0(.315)	24.2(.953)	13.0(.512)	8.0(.315)	6.7(.264)	3.4(.134)	10*100	
	5	#10	HP-PIT-DYF5-5.3S	5.3(.209)	10.0(.394)	26.4(1.039)		9.0(.354)	6.7(.264)	3.4(.134)		
	6	1/4"	HP-PIT-DYF5-6.4S	6.4(.252)	11.0(.433)	28.2(1.110)		10.0(.394)	6.7(.264)	3.4(.134)		
	8	5/16"	HP-PIT-DYF5-8.4S	8.4(.331)	14.0(.551)	32.6(1.283)		13.0(.512)	6.7(.264)	3.4(.134)		

Not so popular size and customized size are available upon requests

WIRE RANGE mm <sup>2</sup> (A.W.G.)	STUD SIZE		ITEM NO.	DIMENSION mm(inch)							PCS/PACK	UL
	mm	inch		d2	W	L	H	F	D	d1		
0.5-1.5 (22-16)	4	#8	HP-PIT-DRF1-4.3(6.8)S	4.3(.169)	6.8(.268)	20.6(.811)	10.0(.394)	7.0(.276))	4.3(.169)	1.7(.067)	10*100	
1.5-2.5 (16-14)	4	#8	HP-PIT-DBF2-4.3(6.8)S	4.3(.169)	6.8(.268)	20.6(.811)	10.0(.394)	7.0(.276))	5.0(.197)	2.3(.091)	10*100	
4-6 (12-10)	10	3/8"	HP-PIT-DYF5-10.5S	10.5(.413)	18.0(.709)	35.6(1.402)	13.0(.512)	15.0(.591)	6.7(.264)	3.4(.134)	10*100	

Add: Floor 4, Building 12, No. 1755, Wenbei Rd., Nanxiang Town, Jiading District, Shanghai, China. P.C.:201802

Website: [www.hampool.com](http://www.hampool.com)

E-mail: [sales@hampool.com](mailto:sales@hampool.com)

[info@hampool.com](mailto:info@hampool.com)

Tel: +86-21-69927650

Fax: +86-21-69927652

Skype: [shrinkproducts](https://www.skype.com/people/shrinkproducts)

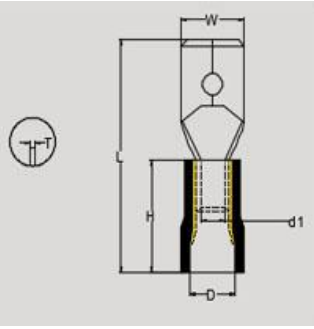

- **Material**
- Insulation: Vinyl
- Terminal Body: Brass
- Metallic Sleeve: Copper
- Plating: Tin
- **Character:**
- Heat Resistance 105°C
- Straight

## MALE TAB TERMINALS

WIRE RANGE mm <sup>2</sup> (A.W.G.)	NEMA TAB Thickness x Width	ITEM NO.	DIMENSION mm(inch)						PACK	UL
			W	L	H	F	C	D		
0.5-1.5 (22-16)	2.8x0.5 .110x.020	HP-PIT-RTAB1-2.8(5)S	2.8(.110)	18.7(.736)	10.0(.394)	6.5(.256)	1.7(.067)	3.9(.154)	10*100	
	2.8x0.8.110x.032	HP-PIT-RTAB1-2.8(8)S				6.5(.256)		3.9(.154)		
	4.8x0.5 .187x.020	HP-PIT-RTAB1-4.8(5)S	4.8(.187)	19.3(.760)		6.7(.264)		3.9(.154)		
	4.8x0.8 .187x.032	HP-PIT-RTAB1-4.8(8)S				6.7(.264)		3.9(.154)		
	6.3x0.8 .250x.032	HP-PIT-RTAB1-6.3(8)S	6.35(.250)	20.8(.819)		7.7(.303)		3.9(.154)		
1.5-2.5 (16-14)	4.8x0.5 .187x.020	HP-PIT-BTAB2-4.8(5)S	4.8(.187)	19.3(.760)	10.0(.394)	6.7(.264)	2.3(.091)	4.7(.185)	10*100	
	4.8x0.8 .187x.032	HP-PIT-BTAB2-4.8(8)S				6.7(.264)		4.7(.185)		
	6.3x0.8 .250x.032	HP-PIT-BTAB2-6.3(8)S	6.35(.250)	20.8(.819)		7.7(.303)		4.7(.185)		
4-6 (12-10)	6.3x0.8 .250x.032	HP-PIT-YTAB5-6.3(8)S	6.35(.250)	24.0(.945)	13.0(.512)	7.7(.303)	3.4(.134)	6.3(.248)	10*100	

Not so popular size and customized Size are available according requests

WIRE RANGE mm <sup>2</sup> (A.W.G.)	NEMA TAB Thickness x Width	ITEM NO.	DIMENSION mm(inch)						PCS/PACK	UL
			W	L	H	F	C	D		
1.5-2.5 (16-14)	2.8x0.5 .110x.020	HP-PIT-BTAB2-2.8(5)S	2.8(.110)	18.7(.736)	10.0(.394)	6.5(.256)	2.3(.091)	4.7(.185)	10*100	
	2.8x0.8.110x.032	HP-PIT-BTAB2-2.8(8)S				6.5(.256)		4.7(.185)		

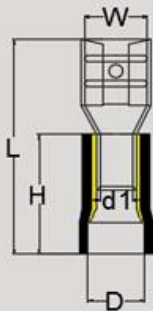

- **Material**
- Insulation: Vinyl
- Terminal Body: Brass
- Metallic Sleeve: Copper
- Plating: Tin

- **Character:**
- Straight

## FEMALE SPADE TERMINALS

WIRE RANGE	NEMA TAB	ITEM NO.	DIMENSION mm(inch)						PACK	UL
			W	L	H	F	C	D		
0.5-1.5 (22-16)	2.8x0.5 .110x.020	HP-PIT-RFS1-2.8(5)S	3.2(.126)	18.8(.740)	10.0(.394)	6.4(.252)	1.7(.067)	3.9(.154)	10*100	
	2.8x0.8 .110x.032	HP-PIT-RFS1-2.8(8)S				6.4(.252)		3.9(.154)		
	4.8x0.5 .187x.020	HP-PIT-RFS1-4.8(5)S	5.0(.197)	19.2(.756)		6.4(.252)	3.9(.154)			
	4.8x0.8 .187x.032	HP-PIT-RFS1-4.8(8)S				6.4(.252)	3.9(.154)			
	6.3x0.8 .250x.032	HP-PIT-RFS1-6.3(8)S				7.2(.283)	3.9(.154)			
1.5-2.5 (16-14)	2.8x0.5 .110x.020	HP-PIT-BFS2-2.8(5)S	3.2(.126)	18.8(.740)	10.0(.394)	6.4(.252)	2.3(.091)	4.7(.185)	10*100	
	2.8x0.8 .110x.032	HP-PIT-BFS2-2.8(8)S				6.4(.252)		4.7(.185)		
	4.8x0.5 .187x.020	HP-PIT-BFS2-4.8(5)S	5.0(.197)	19.2(.756)		6.4(.252)		4.7(.185)		
	4.8x0.8 .187x.032	HP-PIT-BFS2-4.8(8)S				6.4(.252)		4.7(.185)		
	6.3x0.8 .250x.032	HP-PIT-BFS2-6.3(8)S				7.2(.283)		4.7(.185)		
	8.0x0.8 .312x.032	HP-PIT-BFS2-8.0(8)S				10.2(.402)		4.7(.185)		
4-6 (12-10)	6.3x0.8 .250x.032	HP-PIT-YFS5-6.3(8)S	6.6(.260)	23.8(.937)	13.0(.512)	7.2(.283)	3.4(.134)	6.3(.248)	10*100	
	9.4x1.2.375x.047	HP-PIT-YFS5-9.4(12)S	10.0(.394)	28.6(1.126)		12.0(.472)		6.3(.248)		

Not so popular size and customized Size are available according requests

WIRE RANGE	NEMA TAB	ITEM NO.	DIMENSION mm(inch)						PCS/PACK	UL
			W	L	H	F	C	D		
0.5-1.5 (22-16)	8.0x0.8 .312x.032	HP-PIT-RFS1-8.0(8)S	8.2(.323)	24.5(.965)	10.0(.394)	10.0(.394)	1.7(.067)	3.9(.154)	10*100	
1.5-2.5 (16-14)	9.4x1.2.375x.047	HP-PIT-BFS2-9.4(12)S	10.0(.394)	25.6(1.008)	10.0(.394)	12.0(.472)	2.3(.091)	4.7(.185)	10*100	

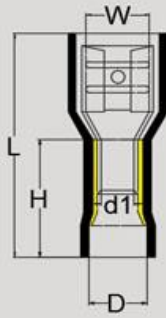

- **Material**
- Insulation: Vinyl
- Terminal Body: Brass
- Metallic Sleeve: Copper
- Plating: Tin
- **Character:**
- Straight

## FEMALE SPADE (FULLY INSULATED) TERMINALS

WIRE RANGE	NEMA TAB Thickness x Width	ITEM NO.	DIMENSION mm(inch)						PACK	UL
			W	L	H	F	C	D		
0.5-1.5 (22-16)	2.8x0.5 .110x.020	HP-PIT-RFSF1-2.8(5)SO	3.2(.126)	18.8(.740)	10.0(.394)	6.4(.252)	1.7(.067)	3.9(.154)	10*100	
	2.8x0.8 .110x.032	HP-PIT-RFSF1-2.8(8)SO				6.4(.252)		3.9(.154)		
	4.8x0.5 .187x.020	HP-PIT-RFSF1-4.8(5)SO	5.0(.197)	19.2(.756)		6.4(.252)		3.9(.154)		
	4.8x0.8 .187x.032	HP-PIT-RFSF1-4.8(8)SO				6.4(.252)		3.9(.154)		
	6.3x0.8 .250x.032	HP-PIT-RFSF1-6.3(8)SO	6.6(.260)	20.8(.819)		7.2(.283)		3.9(.154)		
	6.3x0.8 .250x.032	HP-PIT-RFSF1-6.3(8)SR				7.2(.283)		3.9(.154)		
1.5-2.5 (16-14)	2.8x0.5 .110x.020	HP-PIT-BFSF2-2.8(5)SO	3.2(.126)	18.8(.740)	10.0(.394)	6.4(.252)	2.3(.091)	4.7(.185)	10*100	
	2.8x0.8 .110x.032	HP-PIT-BFSF2-2.8(8)SO				6.4(.252)		4.7(.185)		
	4.8x0.5 .187x.020	HP-PIT-BFSF2-4.8(5)SO	5.0(.197)	19.2(.756)		6.4(.252)		4.7(.185)		
	4.8x0.8 .187x.032	HP-PIT-BFSF2-4.8(8)SO				6.4(.252)		4.7(.185)		
	6.3x0.8 .250x.032	HP-PIT-BFSF2-6.3(8)SO	6.6(.260)	20.8(.819)		7.2(.283)		4.7(.185)		
	6.3x0.8 .250x.032	HP-PIT-BFSF2-6.3(8)SR				7.2(.283)		4.7(.185)		
4-6 (12-10)	6.3x0.8 .250x.032	HP-PIT-YFSF5-6.3(8)SO	6.6(.260)	23.8(.937)	13.0(.512)	7.2(.283)	3.4(.134)	6.3(.248)	10*100	
	9.4x1.2.375x.047	HP-PIT-YFSF5-9.4(12)SO	10.0(.394)	28.6(1.126)		12.0(.472)		6.3(.248)		

Not so popular size and customized Size are available according requests

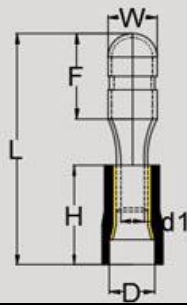

- **Material**
  - Insulation: Vinyl
  - Terminal Body: Brass
  - Metallic Sleeve: Copper
  - Plating: Tin
- **Character:**
  - Straight

## BULLET TERMINALS

WIRE RANGE mm <sup>2</sup> (A.W.G.)	ITEM NO.	DIMENSION mm(inch)						PCS/PACK	UL
		W	L	H	F	C	D		
0.5-1.5 (22-16)	HP-PIT-RBU1-4S	4.0(.157)	21.0(.827)	10.0(.394)	8.5(.335)	1.7(.067)	3.9(.154)	10*100	
1.5-2.5 (16-14)	HP-PIT-BBU2-4S	4.0(.157)	21.0(.827)	10.0(.394)	8.5(.335)	2.3(.091)	4.7(.185)	10*100	
	HP-PIT-BBU2-5S	5.0(.197)	21.5(.846)		9.0(.354)		4.7(.185)		
4-6 (12-10)	HP-PIT-YBU5-5S	5.0(.197)	24.5(.965)	13.0(.512)	9.0(.354)	3.4(.134)	6.3(.248)	10*100	

Not so popular size and customized Size are available according requests

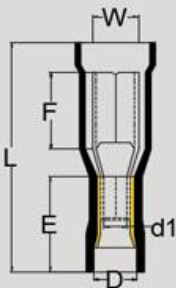

- **Material**
  - Insulation: Vinyl
  - Terminal Body: Brass
  - Metallic Sleeve: Copper
  - Plating: Tin
- **Character:**
  - Straight

## BULLET RECEPTABLE TERMINALS

WIRE RANGE mm <sup>2</sup> (A.W.G.)	ITEM NO.	DIMENSION mm(inch)						PCS/PACK	COLOR
		W	L	H	F	C	D		
0.5-1.5 (22-16)	HP-PIT-RBR1-4S	4.0(.157)	25.0(.984)	10.0(.394)	7.3(.287)	1.7(.067)	3.9(.154)	10*100	
1.5-2.5 (16-14)	HP-PIT-BBR2-4S	4.0(.157)	25.0(.984)	10.0(.394)	7.3(.287)	2.3(.091)	4.7(.185)	10*100	
	HP-PIT-BBR2-5S	5.0(.197)			8.5(.335)		4.7(.185)		
4-6 (12-10)	HP-PIT-YBR5-5S	5.0(.197)	28.0(1.102)	13.0(.512)	8.5(.335)	3.4(.134)	6.3(.248)	10*100	

Not so popular size and customized Size are available according requests



**Hampool Enterprise Co., Limited**

上海涵普实业有限公司

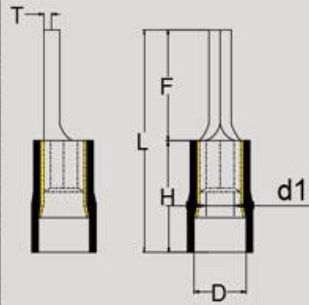

- **Material**
- Insulation: Vinyl
- Terminal Body: Copper
- Metallic Sleeve: Copper
- Plating: Tin
- **Character:**
- Straight
- Better Conduct Connection

## PIN TERMINALS

WIRE RANGE mm <sup>2</sup> (A.W.G.)	ITEM NO.	DIMENSION mm(inch)						PCS/PACK	UL
		W	F	L	H	D	d1		
0.5-1.5 (22-16)	HP-PIT-RP1-9S	1.9(.075)	9.0(.354)	19.0(.748)	10.0(.394)	4.3(.169)	1.7(.067)	10*100	
	HP-PIT-RP1-10S		10.0(.394)	20.0(.787)					
	HP-PIT-RP1-12S		12.0(.472)	22.0(.866)					
1.5-2.5 (16-14)	HP-PIT-BP2-9S	1.9(.075)	9.0(.354)	19.0(.748)	10.0(.394)	5.0(.197)	2.3(.091)	10*100	
	HP-PIT-BP2-10S		10.0(.394)	20.0(.787)					
	HP-PIT-BP2-12S		12.0(.472)	22.0(.866)					
4-6 (12-10)	HP-PIT-YP5-13S	2.8(.110)	14.0(.551)	27.0(1.063)	13.0(.512)	6.7(.264)	3.4(.134)	10*100	

Not so popular size and customized Size are available according requests

WIRE RANGE mm <sup>2</sup> (A.W.G.)	ITEM NO.	DIMENSION mm(inch)						PCS/PACK	UL
		W	F	L	H	D	d1		
0.5-1.5 (22-16)	HP-PIT-RP1-13S	1.9(.075)	13.0(.512)	23.0(.906)	10.0(.394)	4.3(.169)	1.7(.067)	10*100	
1.5-2.5 (16-14)	HP-PIT-BP2-13S	1.9(.075)	13.0(.512)	23.0(.906)	10.0(.394)	5.0(.197)	2.3(.091)	10*100	

Add: Floor 4, Building 12, No. 1755, Wenbei Rd., Nanxiang Town, Jiading District, Shanghai, China. P.C.:201802

Website: [www.hampool.com](http://www.hampool.com)

E-mail: [sales@hampool.com](mailto:sales@hampool.com)

[info@hampool.com](mailto:info@hampool.com)

Tel: +86-21-69927650

Fax: +86-21-69927652

Skype: [shrinkproducts](https://www.skype.com/people/shrinkproducts)



**Hampool Enterprise Co., Limited**

上海涵普实业有限公司

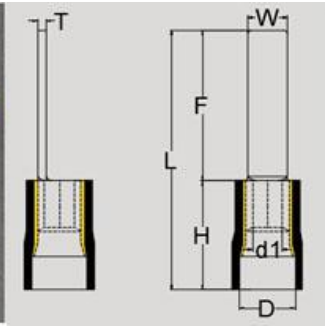

- **Material**
  - Insulation: Vinyl
  - Terminal Body: Copper
  - Metallic Sleeve: Copper
  - Plating: Tin
- **Character:**
  - Straight
  - Better Conduct Connection

## BLADE TERMINALS

WIRE RANGE mm <sup>2</sup> (A.W.G.)	ITEM NO.	DIMENSION mm(inch)						PCS/PACK	UL
		W	F	L	H	D	d1		
0.5-1.5 (22-16)	HP-PIT-RB1-2310S	2.3(.091)	10.0(.394)	20.0(.787)	10.0(.394)	4.3(.169)	1.7(.067)	10*100	
	HP-PIT-RB1-3011S	3.0(.118)	11.0(.433)	21.0(.827)					
	HP-PIT-RB1-3014S		14.0(.551)	24.0(.945)					
	HP-PIT-RB1-2218S	2.2(.087)	18.0(.709)	28.0(1.102)					
1.5-2.5 (16-14)	HP-PIT-BB2-2809S	2.8(.110)	9.0(.354)	19.0(.748)	10.0(.394)	5.0(.197)	2.3(.091)	10*100	
	HP-PIT-BB2-2410S	2.4(.094)	10.0(.394)	20.0(.787)					
	HP-PIT-BB2-2413S		13.0(.512)	23.0(.906)					
	HP-PIT-BB2-2218S	2.2(.079)	18.0(.709)	28.0(1.102)					
4-6 (12-10)	HP-PIT-YB5-2810S	2.8(.110)	10.0(.394)	23.0(.906)	13.0(.512)	6.7(.264)	3.4(.134)	10*100	
	HP-PIT-YB5-4518S	4.5(.177)	18.0(.709)	31.0(1.220)					

Not so popular size and customized Size are available according requests

WIRE RANGE mm <sup>2</sup> (A.W.G.)	ITEM NO.	DIMENSION mm(inch)						PCS/PACK	UL
		W	F	L	H	D	d1		
0.5-1.5 (22-16)	HP-PIT-RB1-2809S	2.8(.110)	9.0(.354)	19.0(.748)	10.0(.394)	4.3(.169)	1.7(.067)	10*100	
	HP-PIT-RB1-2018S	2.0(.079)	18.0(.709)	28.0(1.102)					

Add: Floor 4, Building 12, No. 1755, Wenbei Rd., Nanxiang Town, Jiading District, Shanghai, China. P.C.:201802

Website: [www.hampool.com](http://www.hampool.com)

E-mail: [sales@hampool.com](mailto:sales@hampool.com)

[info@hampool.com](mailto:info@hampool.com)

Tel: +86-21-69927650

Fax: +86-21-69927652

Skype: shrinkproducts

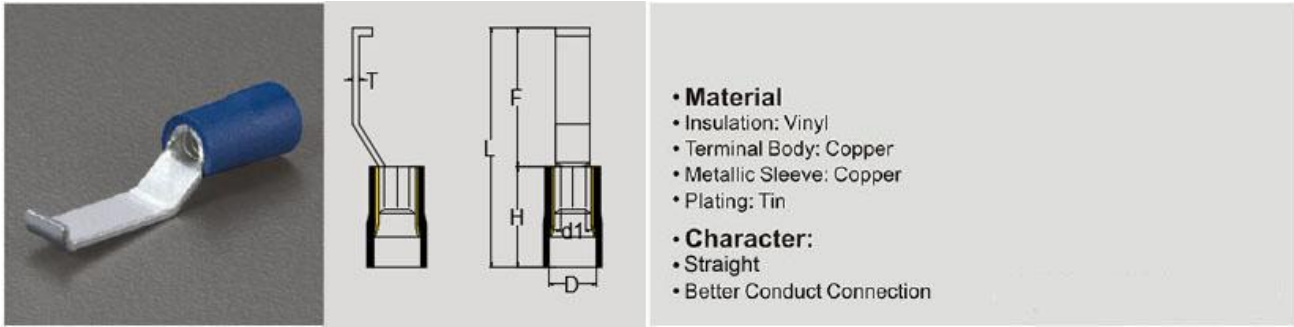

## LIPPED BLADE TERMINALS

WIRE RANGE mm <sup>2</sup> (A.W.G.)	ITEM NO.	DIMENSION mm(inch)							PCS/PACK	COLOR
		W	L	H	F	A	D	d1		
0.5-1.5 (22-16)	HP-PIT-RLB1-3S	3.0(.118)	25.6(1.008)	10.0(.394)	15.6(.614)	2.1(.083)	4.3(.169)	1.7(.067)	10*100	
	HP-PIT-RLB1-4.6S	4.6(.181)								
1.5-2.5 (16-14)	HP-PIT-BLB2-3S	3.0(.118)	25.6(1.008)	10.0(.394)	15.6(.614)	2.1(.083)	5.0(.197)	2.3(.091)	10*100	
	HP-PIT-BLB2-4.6S	4.6(.181)								
4-6 (12-10)	HP-PIT-YLB5-4.6S	4.6(.181)	30.2(1.189)	13.0(.512)	17.2(.677)	2.4(.094)	6.7(.264)	3.4(.134)	10*100	

Not so popular size and customized Size are available according requests

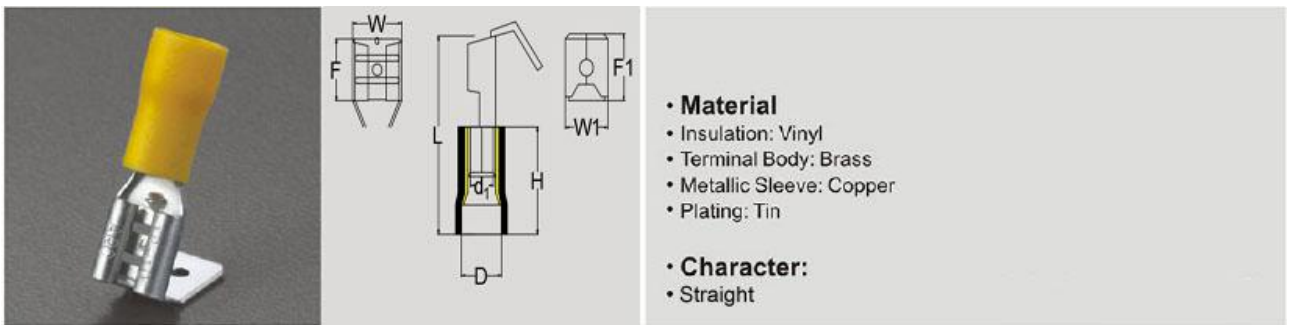

## PIGGY BACK TERMINALS

WIRE RANGE mm <sup>2</sup> (A.W.G.)	NEMA TAB Thickness x Width	ITEM NO.	DIMENSION mm(inch)								PACK	UL
			W	W1	L	F	F1	H	D	d1		
0.5-1.5 (22-16)	6.3x0.8 .250x.032	HP-PIT-RPB1-6.3S	6.6(.260)	6.35(.250)	22.0(.866)	8.0(.315)	8.2(.323)	10.0(.394)	3.9(.154)	1.7(.067)	10*100	
1.5-2.5 (16-14)	6.3x0.8 .250x.032	HP-PIT-BPB2-6.3S	6.6(.260)	6.35(.250)	22.0(.866)	8.0(.315)	8.2(.323)	10.0(.394)	4.7(.185)	2.3(.091)	10*100	
4-6 (12-10)	6.3x0.8 .250x.032	HP-PIT-YPB5-6.3S	6.6(.260)	6.35(.250)	24.5(.965)	8.0(.315)	8.2(.323)	13.0(.512)	6.3(.248)	3.4(.134)	10*100	

Not so popular size and customized Size are available according requests

## Double Crimp Long Straight Sleeve

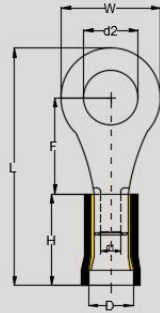

- **Material**
- Insulation: Vinyl
- Terminal Body: Copper
- Metallic Sleeve: Copper
- Plating: Tin
- **Character:**
- Straight
- Better Conduct Connection

### RING TERMINALS

WIRE RANGE mm <sup>2</sup> (A.W.G.)	STUD SIZE		ITEM NO.	DIMENSION mm(inch)							PACK	UL
	mm	inch		d2	W	L	H	F	D	d1		
0.5-1.5 (22-16)	3	#4	HP-PIT-RR1-3.2SL	3.2(.126)	5.7(.216)	17.5(.689)	10.0(.394)	4.8(.189)	4.3(.169)	1.7(.067)	10*100	
	3.5	#6	HP-PIT-RR1-3.7SL	3.7(.146)				4.8(.189)	4.3(.169)	1.7(.067)		
	4	#8	HP-PIT-RR1-4.3SL	4.3(.169)	6.6(.260)	19.4(.784)		6.3(.248)	4.3(.169)	1.7(.067)		
	5	#10	HP-PIT-RR1-5.3SL	5.3(.209)	8.0(.315)	20.8(.819)		7.0(.276)	4.3(.169)	1.7(.067)		
	6	1/4"	HP-PIT-RR1-6.4SL	6.4(.252)	11.6(.457)	26.8(1.055)		8.0(.315)	4.3(.169)	1.7(.067)		
	8	5/16"	HP-PIT-RR1-8.4SL	8.4(.331)				11.0(.433)	4.3(.169)	1.7(.067)		
	10	3/8"	HP-PIT-RR1-10.5SL	10.5(.413)	13.6(.535)	30.5(1.201)		13.9(.547)	4.3(.169)	1.7(.067)		
12	1/2"	HP-PIT-RR1-13.0SL	13.0(.512)	19.2(.756)	35.4(1.394)	15.0(.591)	4.3(.169)	1.7(.067)				
1.5-2.5 (16-14)	3	#4	HP-PIT-BR2-3.2SL	3.2(.126)	6.6(.260)	17.8(.701)	10.0(.394)	4.7(.185)	5.0(.197)	2.3(.091)	10*100	
	3.5	#6	HP-PIT-BR2-3.7SL	3.7(.146)				4.7(.185)	5.0(.197)	2.3(.091)		
	4	#8	HP-PIT-BR2-4.3SL	4.3(.169)	8.5(.335)	19.4(.784)		7.8(.307)	5.0(.197)	2.3(.091)		
	5	#10	HP-PIT-BR2-5.3SL	5.3(.209)				7.8(.307)	5.0(.197)	2.3(.091)		
	6	1/4"	HP-PIT-BR2-6.4SL	6.4(.252)	12.0(.472)	26.8(1.055)		11.0(.433)	5.0(.197)	2.3(.091)		
	8	5/16"	HP-PIT-BR2-8.4SL	8.4(.331)				11.0(.433)	5.0(.197)	2.3(.091)		
	10	3/8"	HP-PIT-BR2-10.5SL	10.5(.413)	13.6(.535)	30.5(1.201)		13.9(.547)	5.0(.197)	2.3(.091)		
12	1/2"	HP-PIT-BR2-13.0SL	13.0(.512)	19.2(.756)	35.4(1.394)	15.0(.591)	5.0(.197)	2.3(.091)				
4-6 (12-10)	3.5	#6	HP-PIT-YR5-3.7SL	3.7(.146)	7.2(.283)	22.7(.894)	13.0(.512)	6.1(.240)	6.7(.264)	3.4(.134)	10*100	
	4	#8	HP-PIT-YR5-4.3SL	4.3(.169)				6.1(.240)	6.7(.264)	3.4(.134)		
	5	#10	HP-PIT-YR5-5.3SL	5.3(.209)	9.5(.374)	26.0(1.023)		8.9(.350)	6.7(.264)	3.4(.134)		
	6	1/4"	HP-PIT-YR5-6.4SL	6.4(.252)	12.0(.472)	29.5(1.167)		9.5(.374)	6.7(.264)	3.4(.134)		
	8	5/16"	HP-PIT-YR5-8.4SL	8.4(.331)				13.0(.512)	6.7(.264)	3.4(.134)		
	10	3/8"	HP-PIT-YR5-10.5SL	10.5(.413)	15.0(.591)	34.0(1.339)		13.5(.531)	6.7(.264)	3.4(.134)		
	12	1/2"	HP-PIT-YR5-13.0SL	13.0(.512)	19.2(.758)	38.6(1.520)		15.0(.591)	6.7(.264)	3.4(.134)		

Not so popular size and customized size are available upon requests

WIRE RANGE mm <sup>2</sup> (A.W.G.)	STUD SIZE		ITEM NO.	DIMENSION mm(inch)							PCS/PAC K	UL
	mm	inch		d2	W	L	H	F	D	d1		
0.5-1.5 (22-16)	3.5	#6	HP-PIT-RR1-3.7(6.6)SL	3.7(.146)	6.6(.260)	19.4(.784)	10.0(.394)	6.3(.248)	4.3(.169)	1.7(.067)	10*100	
	3.5	#6	HP-PIT-RR1-3.7(8)SL	3.7(.146)	8.0(.315)	20.8(.819)		7.0(.276)	4.3(.169)			
	4.0	#8	HP-PIT-RR1-4.3(8)SL	4.3(.169)	8.0(.315)	20.8(.819)		7.0(.276)	4.3(.169)			
1.5-2.5 (16-14)	3.5	#6	HP-PIT-BR2-3.7(6.6M)SL	3.7(.146)	6.6(.260)	17.8(.701)	10.0(.394)	6.3(.248)	5.0(.197)	2.3(.091)	10*100	
	3.5	#6	HP-PIT-BR2-3.7(8.5)SL	5.3(.209)	8.5(.335)	19.4(.784)		7.8(.307)	5.0(.197)			
	4.0	#8	HP-PIT-BR2-4.3(6.6)SL	4.3(.169)	6.6(.260)	19.4(.784)		6.3(.248)	5.0(.197)			
5	#10	HP-PIT-BR2-5.3(9.5)SL	5.3(.209)	9.5(.374)	21.8(.858)	7.1(.280)	5.0(.197)					
4-6 (12-10)	3	#4	HP-PIT-YR5-3.2SL	3.2(.126)	7.2(.283)	22.7(.894)	13.0(.512)	6.1(.240)	6.7(.264)	3.4(.134)	10*100	
	4	#8	HP-PIT-YR5-4.3(9.5)SL	4.3(.169)	9.5(.374)	26.0(1.024)		8.9(.350)	6.7(.264)			

Add: Floor 4, Building 12, No. 1755, Wenbei Rd., Nanxiang Town, Jiading District, Shanghai, China. P.C.:201802

Website: [www.hampool.com](http://www.hampool.com)

E-mail: [sales@hampool.com](mailto:sales@hampool.com)

[info@hampool.com](mailto:info@hampool.com)

Tel: +86-21-69927650

Fax: +86-21-69927652

Skype: [shrinkproducts](https://www.skype.com/people/shrinkproducts)



**Hampool Enterprise Co., Limited**

上海涵普实业有限公司

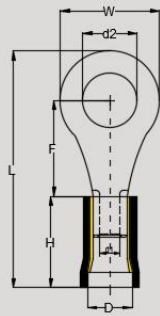

- **Material**
- Insulation: Vinyl
- Terminal Body: Copper
- Metallic Sleeve: Copper
- Plating: Tin
- **Character:**
- Straight
- Better Conduct Connection

## RING TERMINALS (DIN 46237)

WIRE RANGE mm <sup>2</sup> (A.W.G.)	STUD SIZE		ITEM NO.	DIMENSION mm(inch)							PACK	UL
	mm	inch		d2	W	L	H	F	D	d1		
0.5-1.5 (22-16)	3	#4	HP-PIT-DRR1-3.2SL	3.2(.126)	6.0(.236)	19.0(.689)	10.0(.394)	6.0(.236)	4.3(.169)	1.7(.067)	10*100	
	3.5	#6	HP-PIT-DRR1-3.7SL	3.7(.146)				6.0(.236)	4.3(.169)	1.7(.067)		
	4	#8	HP-PIT-DRR1-4.3SL	4.3(.169)	8.0(.315)	21.0(.827)		7.0(.276)	4.3(.169)	1.7(.067)		
	5	#10	HP-PIT-DRR1-5.3SL	5.3(.209)	10.0(.394)	23.0(.906)		8.0(.315)	4.3(.169)	1.7(.067)		
	6	1/4"	HP-PIT-DRR1-6.4SL	6.4(.252)	11.0(.433)	25.5(1.004)		10.0(.394)	4.3(.169)	1.7(.067)		
	8	5/16"	HP-PIT-DRR1-8.4SL	8.4(.331)	14.0(.551)	29.0(1.142)		12.0(.472)	4.3(.169)	1.7(.067)		
	10	3/8"	HP-PIT-DRR1-10.5SL	10.5(.413)	18.0(.709)	33.0(1.299)		14.0(.551)	4.3(.169)	1.7(.067)		
	12	1/2"	HP-PIT-DRR1-13.0SL	13.0(.512)	18.0(.709)	34.0(1.339)	15.0(.591)	4.3(.169)	1.7(.067)			
1.5-2.5 (16-14)	3	#4	HP-PIT-DBR2-3.2SL	3.2(.126)	6.0(.236)	19.0(.689)	10.0(.394)	6.0(.236)	5.0(.197)	2.3(.091)	10*100	
	3.5	#6	HP-PIT-DBR2-3.7SL	3.7(.146)				6.0(.236)	5.0(.197)	2.3(.091)		
	4	#8	HP-PIT-DBR2-4.3SL	4.3(.169)	8.0(.315)	21.0(.827)		7.0(.276)	5.0(.197)	2.3(.091)		
	5	#10	HP-PIT-DBR2-5.3SL	5.3(.209)	10.0(.394)	24.0(.945)		9.0(.354)	5.0(.197)	2.3(.091)		
	6	1/4"	HP-PIT-DBR2-6.4SL	6.4(.252)	11.0(.433)	26.5(1.043)		11.0(.433)	5.0(.197)	2.3(.091)		
	8	5/16"	HP-PIT-DBR2-8.4SL	8.4(.331)	14.0(.551)	29.0(1.142)		12.0(.472)	5.0(.197)	2.3(.091)		
	10	3/8"	HP-PIT-DBR2-10.5SL	10.5(.413)	18.0(.709)	33.0(1.299)		13.5(.531)	5.0(.197)	2.3(.091)		
	12	1/2"	HP-PIT-DBR2-13.0SL	13.0(.512)	18.0(.709)	34.0(1.339)	15.0(.591)	5.0(.197)	2.3(.091)			
4-6 (12-10)	4	#8	HP-PIT-DYR5-4.3SL	4.3(.169)	8.0(.315)	25.0(.984)	13.0(.512)	8.0(.315)	6.7(.264)	3.4(.134)	10*100	
	5	#10	HP-PIT-DYR5-5.3SL	5.3(.209)	10.0(.394)	27.0(1.063)		9.0(.354)	6.7(.264)	3.4(.134)		
	6	1/4"	HP-PIT-DYR5-6.4SL	6.4(.252)	11.0(.433)	28.0(1.102)		10.0(.394)	6.7(.264)	3.4(.134)		
	8	5/16"	HP-PIT-DYR5-8.4SL	8.4(.331)	14.0(.551)	33.0(1.299)		13.0(.512)	6.7(.264)	3.4(.134)		
	10	3/8"	HP-PIT-DYR5-10.5SL	10.5(.413)	18.0(.709)	37.0(1.457)		15.0(.591)	6.7(.264)	3.4(.134)		
	12	1/2"	HP-PIT-DYR5-13.0SL	13.0(.512)	18.0(.709)	37.0(1.457)		15.0(.591)	6.7(.264)	3.4(.134)		

Not so popular size and customized size are available upon requests

WIRE RANGE mm <sup>2</sup> (A.W.G.)	STUD SIZE		ITEM NO.	DIMENSION mm(inch)							PCS/PACK	UL
	mm	inch		d2	W	L	H	F	D	d1		
0.5-1.5 (22-16)	4	#8	HP-PIT-DRR1-4.3(7.0)SL	4.3(.169)	7.0(.276)	20.0(.787)	10.0(.394)	6.5(.248)	4.3(.169)	1.7(.067)	10*100	
	5	#10	HP-PIT-DRR1-5.3(8)SL	5.3(.209)	8.0(.315)	21.5(.846)		7.0(.276)	4.3(.169)			
1.5-2.5 (16-14)	5	#10	HP-PIT-DBR2-5.3(8)SL	5.3(.209)	8.0(.315)	22.5(.886)	10.0(.394)	8.5(.335)	5.0(.197)	2.3(.091)	10*100	

Add: Floor 4, Building 12, No. 1755, Wenbei Rd., Nanxiang Town, Jiading District, Shanghai, China. P.C.:201802

Website: [www.hampool.com](http://www.hampool.com)

E-mail: [sales@hampool.com](mailto:sales@hampool.com)

[info@hampool.com](mailto:info@hampool.com)

Tel: +86-21-69927650

Fax: +86-21-69927652

Skype: [shrinkproducts](https://www.skype.com/people/shrinkproducts)

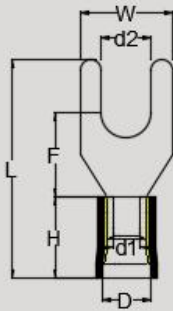

- **Material**
  - Insulation: Vinyl
  - Terminal Body: Copper
  - Metallic Sleeve: Copper
  - Plating: Tin
- **Character:**
  - Straight
  - Better Conduct Connection

## FORK TERMINALS

WIRE RANGE mm <sup>2</sup> (A.W.G.)	STUD SIZE		ITEM NO.	DIMENSION mm(inch)						PACK	UL	
	mm	inch		d2	W	L	H	F	D			d1
0.5-1.5 (22-16)	3	#4	HP-PIT-RF1-3.2SL	3.2(.126)	5.7(.323)	21.0(.827)	10.0(.394)	6.5(.256)	4.3(.169)	1.7(.067)	10*100	
	3.5	#6	HP-PIT-RF1-3.7SL	3.7(.146)				6.5(.256)	4.3(.169)	1.7(.067)		
	4	#8	HP-PIT-RF1-4.3SL	4.3(.169)	6.4(.252)			6.5(.256)	4.3(.169)	1.7(.067)		
	5	#10	HP-PIT-RF1-5.3SL	5.3(.209)	8.1(.319)			6.5(.256)	4.3(.169)	1.7(.067)		
	6	1/4"	HP-PIT-RF1-6.4SL	6.4(.252)	9.5(.374)			6.5(.256)	4.3(.169)	1.7(.067)		
1.5-2.5 (16-14)	3	#4	HP-PIT-BF2-3.2SL	3.2(.126)	5.7(.224)	21.0(.827)	10.0(.394)	6.5(.256)	5.0(.197)	2.3(.091)	10*100	
	3.5	#6	HP-PIT-BF2-3.7SL	3.7(.146)				6.5(.256)	5.0(.197)	2.3(.091)		
	4	#8	HP-PIT-BF2-4.3SL	4.3(.169)	6.4(.252)			6.5(.256)	5.0(.197)	2.3(.091)		
	5	#10	HP-PIT-BF2-5.3SL	5.3(.209)	8.1(.319)			6.5(.256)	5.0(.197)	2.3(.091)		
	6	1/4"	HP-PIT-BF2-6.4SL	6.4(.252)	9.3(.366)			6.5(.256)	5.0(.197)	2.3(.091)		
4-6 (12-10)	3.5	#6	HP-PIT-YF5-3.7SL	3.7(.146)	8.3(.327)	25.5(1.004)	13.0(.512)	7.0(.276)	6.7(.264)	3.4(.134)	10*100	
	4	#8	HP-PIT-YF5-4.3SL	4.3(.169)				7.0(.276)	6.7(.264)	3.4(.134)		
	5	#10	HP-PIT-YF5-5.3SL	5.3(.209)	9.0(.354)			7.0(.276)	6.7(.264)	3.4(.134)		
	6	1/4"	HP-PIT-YF5-6.4SL	6.4(.252)	12.0(.472)			12.0(.472)	6.7(.264)	3.4(.134)		
	8	5/16"	HP-PIT-YF5-8.4SL	8.4(.331)	14.0(.551)			30.5(1.201)	11.5(.453)	6.7(.264)		3.4(.134)

Not so popular size and customized size are available upon requests

WIRE RANGE mm <sup>2</sup> (A.W.G.)	STUD SIZE		ITEM NO.	DIMENSION mm(inch)						PCS/PACK	UL	
	mm	inch		d2	W	L	H	F	D			d1
0.5-1.5 (22-16)	3.5	#6	HP-PIT-RF1-3.7(6.4)SL	3.7(.146)	6.4(.252)	21.0(.827)	10.0(.394)	6.5(.256)	4.3(.169)	1.7(.067)	10*100	
	4	#8	HP-PIT-RF1-4.3(7.2)SL	4.3(.169)	7.2(.283)			6.5(.256)	4.3(.169)			
	8	5/16"	HP-PIT-RF1-8.4SL	8.4(.331)	12.0(.472)	27.2(1.071)		7.0(.276)	4.3(.169)			
1.5-2.5 (16-14)	3.5	#6	HP-PIT-BF2-3.7(6.0)SL	3.7(.146)	6.0(.236)	21.0(.827)	10.0(.394)	6.5(.256)	5.0(.197)	2.3(.091)	10*100	
	3.5	#6	HP-PIT-BF2-3.7(7.2)SL	3.7(.146)	7.2(.283)			6.5(.256)	5.0(.197)			
	4	#8	HP-PIT-BF2-4.3(7.2)SL	4.3(.169)				6.5(.256)	5.0(.197)			
	4	#8	HP-PIT-BF2-4.3(7.9)SL	4.3(.169)	7.9(.311)			6.5(.256)	5.0(.197)			
	5	#10	HP-PIT-BF2-5.3(9.3)SL	5.3(.209)	9.3(.366)			6.5(.256)	5.0(.197)			
4-6 (12-10)	4	#8	HP-PIT-YF5-4.3(9.0)SL	4.3(.169)	9.0(.354)	25.5(1.004)	13.0(.512)	7.0(.276)	6.7(.264)	3.4(.134)	10*100	

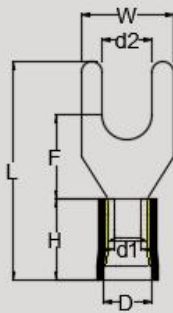

- **Material**
  - Insulation: Vinyl
  - Terminal Body: Copper
  - Metallic Sleeve: Copper
  - Plating: Tin
- **Character:**
  - Straight
  - Better Conduct Connection

## FORK TERMINALS (DIN 46237)

WIRE RANGE mm <sup>2</sup> (A.W.G.)	STUD SIZE		ITEM NO.	DIMENSION mm(inch)						PACK	UL	
	mm	inch		d2	W	L	H	F	D			d1
0.5-1.5 (22-16)	3	#4	HP-PIT-DRF1-3.2SL	3.2(.126)	6.0(.236)	18.6(.732)	10.0(.394)	6.0(.236)	4.3(.169)	1.7(.067)	10*100	
	3.5	#6	HP-PIT-DRF1-3.7SL	3.7(.146)				6.0(.236)	4.3(.169)	1.7(.067)		
	4	#8	HP-PIT-DRF1-4.3SL	4.3(.169)	8.0(.315)	20.6(.811)		7.0(.276))	4.3(.169)	1.7(.067)		
	5	#10	HP-PIT-DRF1-5.3SL	5.3(.209)	10.0(.394)	22.6(.890)		8.0(.315)	4.3(.169)	1.7(.067)		
	6	1/4"	HP-PIT-DRF1-6.4SL	6.4(.252)	11.0(.433)	25.2(.992)		10.0(.394)	4.3(.169)	1.7(.067)		
1.5-2.5 (16-14)	3	#4	HP-PIT-DBF2-3.2SL	3.2(.126)	5.5(.217)	18.6(.732)	10.0(.394)	8.0(.315)	5.0(.197)	2.3(.091)	10*100	
	3.5	#6	HP-PIT-DBF2-3.7SL	3.7(.146)	6.0(.236)			6.0(.236)	5.0(.197)	2.3(.091)		
	4	#8	HP-PIT-DBF2-4.3SL	4.3(.169)	8.0(.315)	20.6(.811)		7.0(.276))	5.0(.197)	2.3(.091)		
	5	#10	HP-PIT-DBF2-5.3SL	5.3(.209)	10.0(.394)	23.6(.929)		9.0(.354)	5.0(.197)	2.3(.091)		
	6	1/4"	HP-PIT-DBF2-6.4SL	6.4(.252)	11.0(.433)	26.2(1.031)		11.0(.433)	5.0(.197)	2.3(.091)		
4-6 (12-10)	4	#8	HP-PIT-DYF5-4.3SL	4.3(.169)	8.0(.315)	24.2(.953)	13.0(.512)	8.0(.315)	6.7(.264)	3.4(.134)	10*100	
	5	#10	HP-PIT-DYF5-5.3SL	5.3(.209)	10.0(.394)	26.4(1.039)		9.0(.354)	6.7(.264)	3.4(.134)		
	6	1/4"	HP-PIT-DYF5-6.4SL	6.4(.252)	11.0(.433)	28.2(1.110)		10.0(.394)	6.7(.264)	3.4(.134)		
	8	5/16"	HP-PIT-DYF5-8.4SL	8.4(.331)	14.0(.551)	32.6(1.283)		13.0(.512)	6.7(.264)	3.4(.134)		

Not so popular size and customized size are available upon requests

WIRE RANGE mm <sup>2</sup> (A.W.G.)	STUD SIZE		ITEM NO.	DIMENSION mm(inch)						PCS/PACK	UL	
	mm	inch		d2	W	L	H	F	D			d1
0.5-1.5 (22-16)	4	#8	HP-PIT-DRF1-4.3(6.8)SL	4.3(.169)	6.8(.268)	20.6(.811)	10.0(.394)	7.0(.276))	4.3(.169)	1.7(.067)	10*100	
1.5-2.5 (16-14)	4	#8	HP-PIT-DBF2-4.3(6.8)SL	4.3(.169)	6.8(.268)	20.6(.811)	10.0(.394)	7.0(.276))	5.0(.197)	2.3(.091)	10*100	
4-6 (12-10)	10	3/8"	HP-PIT-DYF5-10.5SL	10.5(.413)	18.0(.709)	35.6(1.402)	13.0(.512)	15.0(.591)	6.7(.264)	3.4(.134)	10*100	

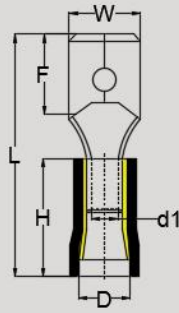

- **Material**
- Insulation: Vinyl
- Terminal Body: Brass
- Metallic Sleeve: Copper
- Plating: Tin
- **Character:**
- Heat Resistance 105°C
- Straight

## MALE TAB TERMINALS

WIRE RANGE mm <sup>2</sup> (A.W.G.)	NEMA TAB Thickness x Width	ITEM NO.	DIMENSION mm(inch)						PACK	UL
			W	L	H	F	C	D		
0.5-1.5 (22-16)	2.8x0.5 .110x.020	HP-PIT-RTAB1-2.8(5)SL	2.8(.110)	19.2(.756)	10.5(.413)	6.5(.256)	1.7(.067)	3.9(.154)	10*100	
	2.8x0.8 .110x.032	HP-PIT-RTAB1-2.8(8)SL				6.5(.256)		3.9(.154)		
	4.8x0.5 .187x.020	HP-PIT-RTAB1-4.8(5)SL	4.8(.187)	19.8(.780)		6.7(.264)		3.9(.154)		
	4.8x0.8 .187x.032	HP-PIT-RTAB1-4.8(8)SL				6.7(.264)	3.9(.154)			
	6.3x0.8 .250x.032	HP-PIT-RTAB1-6.3(8)SL	6.35(.250)	21.8(.858)		7.7(.303)	3.9(.154)			
1.5-2.5 (16-14)	4.8x0.5 .187x.020	HP-PIT-BTAB2-4.8(5)SL	4.8(.187)	19.8(.780)	10.5(.413)	6.7(.264)	2.3(.091)	4.7(.185)	10*100	
	4.8x0.8 .187x.032	HP-PIT-BTAB2-4.8(8)SL				6.7(.264)		4.7(.185)		
	6.3x0.8 .250x.032	HP-PIT-BTAB2-6.3(8)SL	6.35(.250)	21.8(.858)		7.7(.303)		4.7(.185)		
4-6 (12-10)	6.3x0.8 .250x.032	HP-PIT-YTAB5-6.3(8)SL	6.35(.250)	24.0(.945)	13.0(.512)	7.7(.303)	3.4(.134)	6.3(.248)	10*100	

Not so popular size and customized Size are available according requests

WIRE RANGE mm <sup>2</sup> (A.W.G.)	NEMA TAB Thickness x Width	ITEM NO.	DIMENSION mm(inch)						PCS/PACK	UL
			W	L	H	F	C	D		
1.5-2.5 (16-14)	2.8x0.5 .110x.020	HP-PIT-BTAB2-2.8(5)SL	2.8(.110)	19.2(.756)	10.5(.413)	6.5(.256)	2.3(.091)	4.7(.185)	10*100	
	2.8x0.8 .110x.032	HP-PIT-BTAB2-2.8(8)SL				6.5(.256)		4.7(.185)		

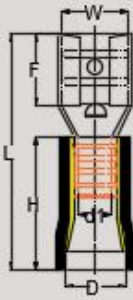

- **Material**
  - Insulation: Vinyl
  - Terminal Body: Brass
  - Metallic Sleeve: Copper
  - Plating: Tin
- **Character:**
  - Straight

## FEMALE SPADE TERMINALS

WIRE RANGE	NEMA TAB	ITEM NO.	DIMENSION mm(inch)						PACK	UL
			W	L	H	F	C	D		
0.5-1.5 (22-16)	2.8x0.5 .110x.020	HP-PIT-RFS1-2.8(5)SL	3.2(.126)	18.8(.740)	10.0(.394)	6.4(.252)	1.7(.067)	3.9(.154)	10*100	
	2.8x0.8 .110x.032	HP-PIT-RFS1-2.8(8)SL				6.4(.252)		3.9(.154)		
	4.8x0.5 .187x.020	HP-PIT-RFS1-4.8(5)SL	5.0(.197)	19.2(.756)		6.4(.252)	3.9(.154)			
	4.8x0.8 .187x.032	HP-PIT-RFS1-4.8(8)SL				6.4(.252)	3.9(.154)			
	6.3x0.8 .250x.032	HP-PIT-RFS1-6.3(8)SL				7.2(.283)	3.9(.154)			
1.5-2.5 (16-14)	2.8x0.5 .110x.020	HP-PIT-BFS2-2.8(5)SL	3.2(.126)	18.8(.740)	10.0(.394)	6.4(.252)	2.3(.091)	4.7(.185)	10*100	
	2.8x0.8 .110x.032	HP-PIT-BFS2-2.8(8)SL				6.4(.252)		4.7(.185)		
	4.8x0.5 .187x.020	HP-PIT-BFS2-4.8(5)SL	5.0(.197)	19.2(.756)		6.4(.252)	4.7(.185)			
	4.8x0.8 .187x.032	HP-PIT-BFS2-4.8(8)SL				6.4(.252)	4.7(.185)			
	6.3x0.8 .250x.032	HP-PIT-BFS2-6.3(8)SL				7.2(.283)	4.7(.185)			
4-6 (12-10)	6.3x0.8 .250x.032	HP-PIT-YFS5-6.3(8)SL	8.2(.323)	24.5(.965)	13.0(.512)	7.2(.283)	3.4(.134)	6.3(.248)	10*100	
	9.4x1.2.375x.047	HP-PIT-YFS5-9.4(12)SL	10.0(.394)	28.6(1.126)		12.0(.472)		6.3(.248)		

Not so popular size and customized Size are available according requests

WIRE RANGE	NEMA TAB	ITEM NO.	DIMENSION mm(inch)						PCS/PACK	UL
			W	L	H	F	C	D		
0.5-1.5 (22-16)	8.0x0.8 .312x.032	HP-PIT-RFS1-8.0(8)SL	8.2(.323)	24.5(.965)	10.0(.394)	10.0(.394)	1.7(.067)	3.9(.154)	10*100	
1.5-2.5 (16-14)	9.4x1.2.375x.047	HP-PIT-BFS2-9.4(12)SL	10.0(.394)	25.6(1.008)	10.0(.394)	12.0(.472)	2.3(.091)	4.7(.185)	10*100	

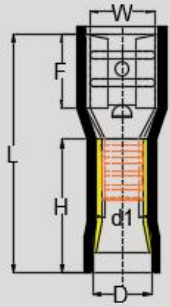

- **Material**
- Insulation: Vinyl
- Terminal Body: Brass
- Metallic Sleeve: Copper
- Plating: Tin
  
- **Character:**
- Straight

## FEMALE SPADE (FULLY INSULATED) TERMINALS

WIRE RANGE	NEMA TAB	ITEM NO.	DIMENSION mm(inch)						PACK	UL
			W	L	H	F	C	D		
0.5-1.5 (22-16)	2.8x0.5 .110x.020	HP-PIT-RFSF1-2.8(5)SLO	3.2(.126)	18.8(.740)	10.0(.394)	6.4(.252)	1.7(.067)	3.9(.154)	10*100	
	2.8x0.8.110x.032	HP-PIT-RFSF1-2.8(8)SLO				6.4(.252)		3.9(.154)		
	4.8x0.5 .187x.020	HP-PIT-RFSF1-4.8(5)SLO	5.0(.197)	19.2(.756)		6.4(.252)		3.9(.154)		
	4.8x0.8 .187x.032	HP-PIT-RFSF1-4.8(8)SLO				6.4(.252)		3.9(.154)		
	6.3x0.8 .250x.032	HP-PIT-RFSF1-6.3(8)SLO	6.6(.260)	20.8(.819)		7.2(.283)		3.9(.154)		
	6.3x0.8 .250x.032	HP-PIT-RFSF1-6.3(8)SLR				7.2(.283)		3.9(.154)		
1.5-2.5 (16-14)	2.8x0.5 .110x.020	HP-PIT-BFSF2-2.8(5)SLO	3.2(.126)	18.8(.740)	10.0(.394)	6.4(.252)	2.3(.091)	4.7(.185)	10*100	
	2.8x0.8.110x.032	HP-PIT-BFSF2-2.8(8)SLO				6.4(.252)		4.7(.185)		
	4.8x0.5 .187x.020	HP-PIT-BFSF2-4.8(5)SLO	5.0(.197)	19.2(.756)		6.4(.252)		4.7(.185)		
	4.8x0.8 .187x.032	HP-PIT-BFSF2-4.8(8)SLO				6.4(.252)		4.7(.185)		
	6.3x0.8 .250x.032	HP-PIT-BFSF2-6.3(8)SLO	6.6(.260)	20.8(.819)		7.2(.283)		4.7(.185)		
	6.3x0.8 .250x.032	HP-PIT-BFSF2-6.3(8)SLR				7.2(.283)		4.7(.185)		
4-6 (12-10)	6.3x0.8 .250x.032	HP-PIT-YFSF5-6.3(8)SLO	6.6(.260)	23.8(.937)	13.0(.512)	7.2(.283)	3.4(.134)	6.3(.248)	10*100	
	9.4x1.2.375x.047	HP-PIT-YFSF5-9.4(12)SLO	10.0(.394)	28.6(1.126)		12.0(.472)		6.3(.248)		

Not so popular size and customized Size are available according requests

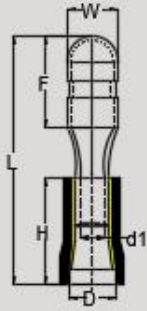

- **Material**
  - Insulation: Vinyl
  - Terminal Body: Brass
  - Metallic Sleeve: Copper
  - Plating: Tin
- **Character:**
  - Straight

## BULLET TERMINALS

WIRE RANGE mm <sup>2</sup> (A.W.G.)	ITEM NO.	DIMENSION mm(inch)						PCS/PACK	UL
		W	L	H	F	C	D		
0.5-1.5 (22-16)	HP-PIT-RBU1-4SL	4.0(.157)	21.0(.827)	10.0(.394)	8.5(.335)	1.7(.067)	3.9(.154)	10*100	
1.5-2.5 (16-14)	HP-PIT-BBU2-4SL	4.0(.157)	21.0(.827)	10.0(.394)	8.5(.335)	2.3(.091)	4.7(.185)	10*100	
	HP-PIT-BBU2-5SL	5.0(.197)	21.5(.846)		9.0(.354)		4.7(.185)		
4-6 (12-10)	HP-PIT-YBU5-5SL	5.0(.197)	24.5(.965)	13.0(.512)	9.0(.354)	3.4(.134)	6.3(.248)	10*100	

Not so popular size and customized Size are available according requests

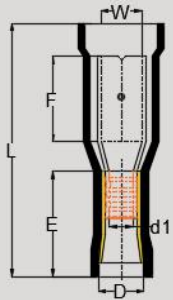

- **Material**
  - Insulation: Vinyl
  - Terminal Body: Brass
  - Metallic Sleeve: Copper
  - Plating: Tin
- **Character:**
  - Straight

## BULLET RECEPTABLE TERMINALS

WIRE RANGE mm <sup>2</sup> (A.W.G.)	ITEM NO.	DIMENSION mm(inch)						PCS/PACK	COLOR
		W	L	H	F	C	D		
0.5-1.5 (22-16)	HP-PIT-RBR1-4SL	4.0(.157)	25.0(.984)	10.0(.394)	7.3(.287)	1.7(.067)	3.9(.154)	10*100	
1.5-2.5 (16-14)	HP-PIT-BBR2-4SL	4.0(.157)	25.0(.984)	10.0(.394)	7.3(.287)	2.3(.091)	4.7(.185)	10*100	
	HP-PIT-BBR2-5SL	5.0(.197)			8.5(.335)		4.7(.185)		
4-6 (12-10)	HP-PIT-YBR5-5SL	5.0(.197)	28.0(1.102)	13.0(.512)	8.5(.335)	3.4(.134)	6.3(.248)	10*100	

Not so popular size and customized Size are available according requests



**Hampool Enterprise Co., Limited**

上海涵普实业有限公司

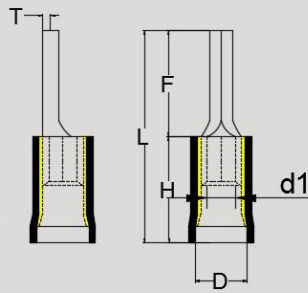

- **Material**
- Insulation: Vinyl
- Terminal Body: Copper
- Metallic Sleeve: Copper
- Plating: Tin
- **Character:**
- Straight
- Better Conduct Connection

## PIN TERMINALS

WIRE RANGE mm <sup>2</sup> (A.W.G.)	ITEM NO.	DIMENSION mm(inch)						PCS/PACK	UL
		W	F	L	H	D	d1		
0.5-1.5 (22-16)	HP-PIT-RP1-9SL	1.9(.075)	9.0(.354)	19.0(.748)	10.0(.394)	4.3(.169)	1.7(.067)	10*100	
	HP-PIT-RP1-10SL		10.0(.394)	20.0(.787)					
	HP-PIT-RP1-12SL		12.0(.472)	22.0(.866)					
1.5-2.5 (16-14)	HP-PIT-BP2-9SL	1.9(.075)	9.0(.354)	19.0(.748)	10.0(.394)	5.0(.197)	2.3(.091)	10*100	
	HP-PIT-BP2-10SL		10.0(.394)	20.0(.787)					
	HP-PIT-BP2-12SL		12.0(.472)	22.0(.866)					
4-6 (12-10)	HP-PIT-YP5-13SL	2.8(.110)	14.0(.551)	27.0(1.063)	13.0(.512)	6.7(.264)	3.4(.134)	10*100	

Not so popular size and customized Size are available according requests

WIRE RANGE mm <sup>2</sup> (A.W.G.)	ITEM NO.	DIMENSION mm(inch)						PCS/PACK	UL
		W	F	L	H	D	d1		
0.5-1.5 (22-16)	HP-PIT-RP1-13SL	1.9(.075)	13.0(.512)	23.0(.906)	10.0(.394)	4.3(.169)	1.7(.067)	10*100	
1.5-2.5 (16-14)	HP-PIT-BP2-13SL	1.9(.075)	13.0(.512)	23.0(.906)	10.0(.394)	5.0(.197)	2.3(.091)	10*100	

Add: Floor 4, Building 12, No. 1755, Wenbei Rd., Nanxiang Town, Jiading District, Shanghai, China. P.C.:201802

Website: [www.hampool.com](http://www.hampool.com)

E-mail: [sales@hampool.com](mailto:sales@hampool.com)

[info@hampool.com](mailto:info@hampool.com)

Tel: +86-21-69927650

Fax: +86-21-69927652

Skype: shrinkproducts



**Hampool Enterprise Co., Limited**

上海涵普实业有限公司

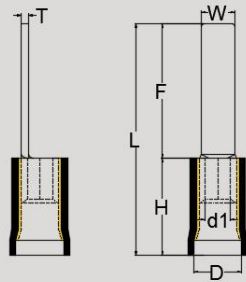

- **Material**
- Insulation: Vinyl
- Terminal Body: Copper
- Metallic Sleeve: Copper
- Plating: Tin
- **Character:**
- Straight
- Better Conduct Connection

## BLADE TERMINALS

WIRE RANGE mm <sup>2</sup> (A.W.G.)	ITEM NO.	DIMENSION mm(inch)						PCS/PACK	UL
		W	F	L	H	D	d1		
0.5-1.5 (22-16)	HP-PIT-RB1-2310SL	2.3(.091)	10.0(.394)	20.0(.787)	10.0(.394)	4.3(.169)	1.7(.067)	10*100	
	HP-PIT-RB1-3011SL	3.0(.118)	11.0(.433)	21.0(.827)					
	HP-PIT-RB1-3014SL		14.0(.551)	24.0(.945)					
	HP-PIT-RB1-2218SL	2.2(.087)	18.0(.709)	28.0(1.102)					
1.5-2.5 (16-14)	HP-PIT-BB2-2809SL	2.8(.110)	9.0(.354)	19.0(.748)	10.0(.394)	5.0(.197)	2.3(.091)	10*100	
	HP-PIT-BB2-2410SL	2.4(.094)	10.0(.394)	20.0(.787)					
	HP-PIT-BB2-2413SL		13.0(.512)	23.0(.906)					
	HP-PIT-BB2-2218SL	2.2(.079)	18.0(.709)	28.0(1.102)					
4-6 (12-10)	HP-PIT-YB5-2810SL	2.8(.110)	10.0(.394)	23.0(.906)	13.0(.512)	6.7(.264)	3.4(.134)	10*100	
	HP-PIT-YB5-4518SL	4.5(.177)	18.0(.709)	31.0(1.220)					

Not so popular size and customized Size are available according requests

WIRE RANGE mm <sup>2</sup> (A.W.G.)	ITEM NO.	DIMENSION mm(inch)						PCS/PACK	UL
		W	F	L	H	D	d1		
0.5-1.5 (22-16)	HP-PIT-RB1-2809SL	2.8(.110)	9.0(.354)	19.0(.748)	10.0(.394)	4.3(.169)	1.7(.067)	10*100	
	HP-PIT-RB1-2018SL	2.0(.079)	18.0(.709)	28.0(1.102)					

Add: Floor 4, Building 12, No. 1755, Wenbei Rd., Nanxiang Town, Jiading District, Shanghai, China. P.C.:201802

Website: [www.hampool.com](http://www.hampool.com)

E-mail: [sales@hampool.com](mailto:sales@hampool.com)

[info@hampool.com](mailto:info@hampool.com)

Tel: +86-21-69927650

Fax: +86-21-69927652

Skype: shrinkproducts

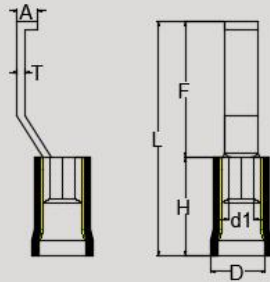

- **Material**
- Insulation: Vinyl
- Terminal Body: Copper
- Metallic Sleeve: Copper
- Plating: Tin
- **Character:**
- Straight
- Better Conduct Connection

## LIPPED BLADE TERMINALS

WIRE RANGE mm <sup>2</sup> (A.W.G.)	ITEM NO.	DIMENSION mm(inch)							PCS/PACK	COLOR
		W	L	H	F	A	D	d1		
0.5-1.5 (22-16)	HP-PIT-RLB1-3SL	3.0(.118)	25.6(1.008)	10.0(.394)	15.6(.614)	2.1(.083)	4.3(.169)	1.7(.067)	10*100	
	HP-PIT-RLB1-4.6SL	4.6(.181)								
1.5-2.5 (16-14)	HP-PIT-BLB2-3SL	3.0(.118)	25.6(1.008)	10.0(.394)	15.6(.614)	2.1(.083)	5.0(.197)	2.3(.091)	10*100	
	HP-PIT-BLB2-4.6SL	4.6(.181)								
4-6 (12-10)	HP-PIT-YLB5-4.6SL	4.6(.181)	30.2(1.189)	13.0(.512)	17.2(.677)	2.4(.094)	6.7(.264)	3.4(.134)	10*100	

Not so popular size and customized Size are available according requests

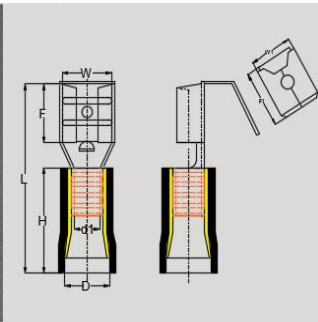
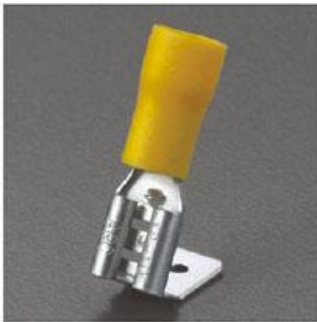

- **Material**
- Insulation: Vinyl
- Terminal Body: Brass
- Metallic Sleeve: Copper
- Plating: Tin
- **Character:**
- Straight

## PIGGY BACK TERMINALS

WIRE RANGE mm <sup>2</sup> (A.W.G.)	NEMA TAB Thickness x Width	ITEM NO.	DIMENSION mm(inch)								PACK	UL
			W	W1	L	F	F1	H	D	d1		
0.5-1.5 (22-16)	6.3x0.8 .250x.032	HP-PIT-RPB1-6.3SL	6.6(.260)	6.35(.250)	22.0(.866)	8.0(.315)	8.2(.323)	10.0(.394)	3.9(.154)	1.7(.067)	10*100	
1.5-2.5 (16-14)	6.3x0.8 .250x.032	HP-PIT-BPB2-6.3SL	6.6(.260)	6.35(.250)	22.0(.866)	8.0(.315)	8.2(.323)	10.0(.394)	4.7(.185)	2.3(.091)	10*100	
4-6 (12-10)	6.3x0.8 .250x.032	HP-PIT-YPB5-6.3SL	6.6(.260)	6.35(.250)	24.5(.965)	8.0(.315)	8.2(.323)	13.0(.512)	6.3(.248)	3.4(.134)	10*100	

Not so popular size and customized Size are available according requests

## Double Crimp Easy Entry Sleeve

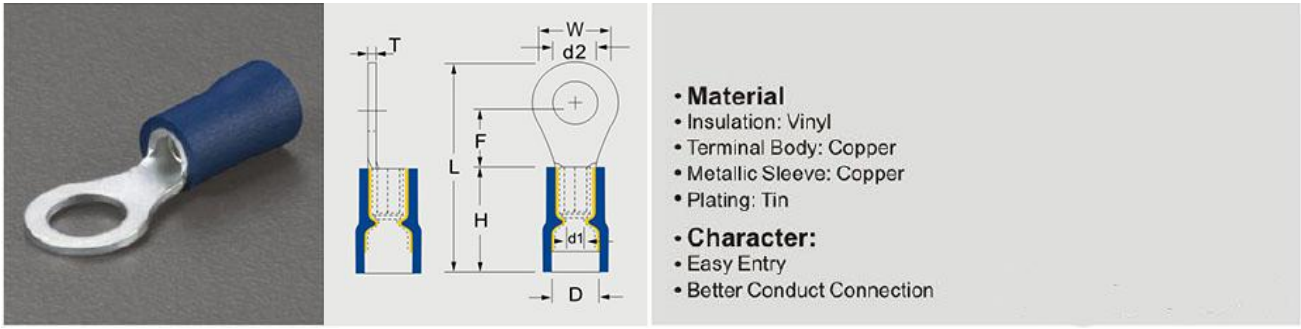

## RING TERMINALS

WIRE RANGE mm <sup>2</sup> (A.W.G.)	STUD SIZE		ITEM NO.	DIMENSION mm(inch)						PACK	UL
	mm	inch		d2	W	L	H	F	D		
0.5-1.5 (22-16)	3	#4	HP-PIT-RR1-3.2E	3.2(.126)	5.7(.216)	17.5(.689)	10.0(.394)	4.8(.189)	4.3(.169)	1.7(.067)	10*100
	3.5	#6	HP-PIT-RR1-3.7E	3.7(.146)				4.8(.189)	4.3(.169)	1.7(.067)	
	4	#8	HP-PIT-RR1-4.3E	4.3(.169)	6.6(.260)	19.4(.784)		6.3(.248)	4.3(.169)	1.7(.067)	
	5	#10	HP-PIT-RR1-5.3E	5.3(.209)	8.0(.315)	20.8(.819)		7.0(.276)	4.3(.169)	1.7(.067)	
	6	1/4"	HP-PIT-RR1-6.4E	6.4(.252)	11.6(.457)	26.8(1.055)		8.0(.315)	4.3(.169)	1.7(.067)	
	8	5/16"	HP-PIT-RR1-8.4E	8.4(.331)				11.0(.433)	4.3(.169)	1.7(.067)	
	10	3/8"	HP-PIT-RR1-10.5E	10.5(.413)	13.6(.535)	30.5(1.201)		13.9(.547)	4.3(.169)	1.7(.067)	
12	1/2"	HP-PIT-RR1-13.0E	13.0(.512)	19.2(.756)	35.4(1.394)	15.0(.591)	4.3(.169)	1.7(.067)			
1.5-2.5 (16-14)	3	#4	HP-PIT-BR2-3.2E	3.2(.126)	6.6(.260)	17.8(.701)	10.0(.394)	4.7(.185)	5.0(.197)	2.3(.091)	10*100
	3.5	#6	HP-PIT-BR2-3.7E	3.7(.146)				4.7(.185)	5.0(.197)	2.3(.091)	
	4	#8	HP-PIT-BR2-4.3E	4.3(.169)	8.5(.335)	19.4(.784)		7.8(.307)	5.0(.197)	2.3(.091)	
	5	#10	HP-PIT-BR2-5.3E	5.3(.209)				7.8(.307)	5.0(.197)	2.3(.091)	
	6	1/4"	HP-PIT-BR2-6.4E	6.4(.252)	12.0(.472)	26.8(1.055)		11.0(.433)	5.0(.197)	2.3(.091)	
	8	5/16"	HP-PIT-BR2-8.4E	8.4(.331)				11.0(.433)	5.0(.197)	2.3(.091)	
	10	3/8"	HP-PIT-BR2-10.5E	10.5(.413)	13.6(.535)	30.5(1.201)		13.9(.547)	5.0(.197)	2.3(.091)	
12	1/2"	HP-PIT-BR2-13.0E	13.0(.512)	19.2(.756)	35.4(1.394)	15.0(.591)	5.0(.197)	2.3(.091)			
4-6 (12-10)	3.5	#6	HP-PIT-YR5-3.7E	3.7(.146)	7.2(.283)	22.7(.894)	13.0(.512)	6.1(.240)	6.7(.264)	3.4(.134)	10*100
	4	#8	HP-PIT-YR5-4.3E	4.3(.169)				6.1(.240)	6.7(.264)	3.4(.134)	
	5	#10	HP-PIT-YR5-5.3E	5.3(.209)	9.5(.374)	26.0(1.023)		8.9(.350)	6.7(.264)	3.4(.134)	
	6	1/4"	HP-PIT-YR5-6.4E	6.4(.252)	12.0(.472)	29.5(1.167)		9.5(.374)	6.7(.264)	3.4(.134)	
	8	5/16"	HP-PIT-YR5-8.4E	8.4(.331)				13.0(.512)	6.7(.264)	3.4(.134)	
	10	3/8"	HP-PIT-YR5-10.5E	10.5(.413)	15.0(.591)	34.0(1.339)		13.5(.531)	6.7(.264)	3.4(.134)	
	12	1/2"	HP-PIT-YR5-13.0E	13.0(.512)	19.2(.758)	38.6(1.520)		15.0(.591)	6.7(.264)	3.4(.134)	

Not so popular size and customized size are available upon requests

WIRE RANGE mm <sup>2</sup> (A.W.G.)	STUD SIZE		ITEM NO.	DIMENSION mm(inch)						PCS/PAC K	UL
	mm	inch		d2	W	L	E	F	D		
0.5-1.5 (22-16)	3.5	#6	HP-PIT-RR1-3.7(6.6)E	3.7(.146)	6.6(.260)	19.4(.784)	10.0(.394)	6.3(.248)	4.3(.169)	1.7(.067)	10*100
	3.5	#6	HP-PIT-RR1-3.7(8)E	3.7(.146)	8.0(.315)	20.8(.819)		7.0(.276)	4.3(.169)		
	4.0	#8	HP-PIT-RR1-4.3(8)E	4.3(.169)	8.0(.315)	20.8(.819)		7.0(.276)	4.3(.169)		
1.5-2.5 (16-14)	3.5	#6	HP-PIT-BR2-3.7(6.6)E	3.7(.146)	6.6(.260)	17.8(.701)	10.0(.394)	6.3(.248)	5.0(.197)	2.3(.091)	10*100
	3.5	#6	HP-PIT-BR2-3.7(8.5)E	5.3(.209)	8.5(.335)	19.4(.784)		7.8(.307)	5.0(.197)		
	4.0	#8	HP-PIT-BR2-4.3(6.6)E	4.3(.169)	6.6(.260)	19.4(.784)		6.3(.248)	5.0(.197)		
4-6 (12-10)	3	#4	HP-PIT-YR5-3.2E	3.2(.126)	7.2(.283)	22.7(.894)	13.0(.512)	6.1(.240)	6.7(.264)	3.4(.134)	10*100
	4	#8	HP-PIT-YR5-4.3(9.5)E	4.3(.169)	9.5(.374)	26.0(1.024)		8.9(.350)	6.7(.264)		



**Hampool Enterprise Co., Limited**

上海涵普实业有限公司

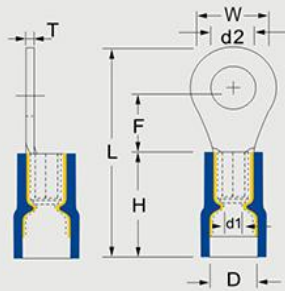

- **Material**
- Insulation: Vinyl
- Terminal Body: Copper
- Metallic Sleeve: Copper
- Plating: Tin
- **Character:**
- Easy Entry
- Better Conduct Connection

## RING TERMINALS (DIN 46237)

WIRE RANGE mm <sup>2</sup> (A.W.G.)	STUD SIZE		ITEM NO.	DIMENSION mm(inch)						PACK	UL	
	mm	inch		d2	W	L	H	F	D			d1
0.5-1.5 (22-16)	3	#4	HP-PIT-DRR1-3.2E	3.2(.126)	6.0(.236)	19.0(.689)	10.0(.394)	6.0(.236)	4.3(.169)	1.7(.067)	10*100	
	3.5	#6	HP-PIT-DRR1-3.7E	3.7(.146)				6.0(.236)	4.3(.169)	1.7(.067)		
	4	#8	HP-PIT-DRR1-4.3E	4.3(.169)	8.0(.315)	21.0(.827)		7.0(.276)	4.3(.169)	1.7(.067)		
	5	#10	HP-PIT-DRR1-5.3E	5.3(.209)	10.0(.394)	23.0(.906)		8.0(.315)	4.3(.169)	1.7(.067)		
	6	1/4"	HP-PIT-DRR1-6.4E	6.4(.252)	11.0(.433)	25.5(1.004)		10.0(.394)	4.3(.169)	1.7(.067)		
	8	5/16"	HP-PIT-DRR1-8.4E	8.4(.331)	14.0(.551)	29.0(1.142)		12.0(.472)	4.3(.169)	1.7(.067)		
	10	3/8"	HP-PIT-DRR1-10.5E	10.5(.413)	18.0(.709)	33.0(1.299)		14.0(.551)	4.3(.169)	1.7(.067)		
	12	1/2"	HP-PIT-DRR1-13.0E	13.0(.512)	18.0(.709)	34.0(1.339)	15.0(.591)	4.3(.169)	1.7(.067)			
1.5-2.5 (16-14)	3	#4	HP-PIT-DBR2-3.2E	3.2(.126)	6.0(.236)	19.0(.689)	10.0(.394)	6.0(.236)	5.0(.197)	2.3(.091)	10*100	
	3.5	#6	HP-PIT-DBR2-3.7E	3.7(.146)				6.0(.236)	5.0(.197)	2.3(.091)		
	4	#8	HP-PIT-DBR2-4.3E	4.3(.169)	8.0(.315)	21.0(.827)		7.0(.276)	5.0(.197)	2.3(.091)		
	5	#10	HP-PIT-DBR2-5.3E	5.3(.209)	10.0(.394)	24.0(.945)		9.0(.354)	5.0(.197)	2.3(.091)		
	6	1/4"	HP-PIT-DBR2-6.4E	6.4(.252)	11.0(.433)	26.5(1.043)		11.0(.433)	5.0(.197)	2.3(.091)		
	8	5/16"	HP-PIT-DBR2-8.4E	8.4(.331)	14.0(.551)	29.0(1.142)		12.0(.472)	5.0(.197)	2.3(.091)		
	10	3/8"	HP-PIT-DBR2-10.5E	10.5(.413)	18.0(.709)	33.0(1.299)		13.5(.531)	5.0(.197)	2.3(.091)		
	12	1/2"	HP-PIT-DBR2-13.0E	13.0(.512)	18.0(.709)	34.0(1.339)	15.0(.591)	5.0(.197)	2.3(.091)			
4-6 (12-10)	4	#8	HP-PIT-DYR5-4.3E	4.3(.169)	8.0(.315)	25.0(.984)	13.0(.512)	8.0(.315)	6.7(.264)	3.4(.134)	10*100	
	5	#10	HP-PIT-DYR5-5.3E	5.3(.209)	10.0(.394)	27.0(1.063)		9.0(.354)	6.7(.264)	3.4(.134)		
	6	1/4"	HP-PIT-DYR5-6.4E	6.4(.252)	11.0(.433)	28.0(1.102)		10.0(.394)	6.7(.264)	3.4(.134)		
	8	5/16"	HP-PIT-DYR5-8.4E	8.4(.331)	14.0(.551)	33.0(1.299)		13.0(.512)	6.7(.264)	3.4(.134)		
	10	3/8"	HP-PIT-DYR5-10.5E	10.5(.413)	18.0(.709)	37.0(1.457)		15.0(.591)	6.7(.264)	3.4(.134)		
	12	1/2"	HP-PIT-DYR5-13.0E	13.0(.512)	18.0(.709)	37.0(1.457)		15.0(.591)	6.7(.264)	3.4(.134)		

Not so popular size and customized size are available upon requests

WIRE RANGE mm <sup>2</sup> (A.W.G.)	STUD SIZE		ITEM NO.	DIMENSION mm(inch)						PCS/PACK	UL	
	mm	inch		d2	W	L	E	F	D			d1
0.5-1.5 (22-16)	4	#8	HP-PIT-DRR1-4.3(7.0)E	4.3(.169)	7.0(.276)	20.0(.787)	10.0(.394)	6.5(.248)	4.3(.169)	1.7(.067)	10*100	
	5	#10	HP-PIT-DRR1-5.3(8)E	5.3(.209)	8.0(.315)	21.5(.846)		7.0(.276)	4.3(.169)			
1.5-2.5 (16-14)	5	#10	HP-PIT-DBR2-5.3(8)E	5.3(.209)	8.0(.315)	22.5(.886)	10.0(.394)	8.5(.335)	5.0(.197)	2.3(.091)	10*100	

Add: Floor 4, Building 12, No. 1755, Wenbei Rd., Nanxiang Town, Jiading District, Shanghai, China. P.C.:201802

Website: [www.hampool.com](http://www.hampool.com)

E-mail: [sales@hampool.com](mailto:sales@hampool.com)

[info@hampool.com](mailto:info@hampool.com)

Tel: +86-21-69927650

Fax: +86-21-69927652

Skype: [shrinkproducts](https://www.skype.com/people/shrinkproducts)

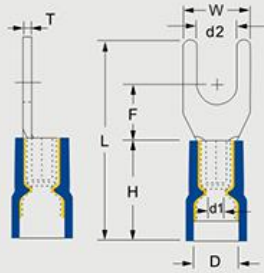

- **Material**
- Insulation: Vinyl
- Terminal Body: Copper
- Metallic Sleeve: Copper
- Plating: Tin
- **Character:**
- Easy Entry
- Better Conduct Connection

## FORK TERMINALS

WIRE RANGE mm <sup>2</sup> (A.W.G.)	STUD SIZE		ITEM NO.	DIMENSION mm(inch)							PACK	UL
	mm	inch		d2	W	L	H	F	D	d1		
0.5-1.5 (22-16)	3	#4	HP-PIT-RF1-3.2E	3.2(.126)	5.7(.323)	21.0(.827)	10.0(.394)	6.5(.256)	4.3(.169)	1.7(.067)	10*100	
	3.5	#6	HP-PIT-RF1-3.7E	3.7(.146)				6.5(.256)	4.3(.169)	1.7(.067)		
	4	#8	HP-PIT-RF1-4.3E	4.3(.169)	6.4(.252)			6.5(.256)	4.3(.169)	1.7(.067)		
	5	#10	HP-PIT-RF1-5.3E	5.3(.209)	8.1(.319)			6.5(.256)	4.3(.169)	1.7(.067)		
1.5-2.5 (16-14)	3	#4	HP-PIT-BF2-3.2E	3.2(.126)	5.7(.224)	21.0(.827)	10.0(.394)	6.5(.256)	5.0(.197)	2.3(.091)	10*100	
	3.5	#6	HP-PIT-BF2-3.7E	3.7(.146)				6.5(.256)	5.0(.197)	2.3(.091)		
	4	#8	HP-PIT-BF2-4.3E	4.3(.169)	6.4(.252)			6.5(.256)	5.0(.197)	2.3(.091)		
	5	#10	HP-PIT-BF2-5.3E	5.3(.209)	8.1(.319)			6.5(.256)	5.0(.197)	2.3(.091)		
4-6 (12-10)	3.5	#6	HP-PIT-YF5-3.7E	3.7(.146)	8.3(.327)	25.5(1.004)	13.0(.512)	7.0(.276))	6.7(.264)	3.4(.134)	10*100	
	4	#8	HP-PIT-YF5-4.3S	4.3(.169)				7.0(.276))	6.7(.264)	3.4(.134)		
	5	#10	HP-PIT-YF5-5.3E	5.3(.209)	9.0(.354)	7.0(.276))		6.7(.264)	3.4(.134)			
	6	1/4"	HP-PIT-YF5-6.4E	6.4(.252)	12.0(.472)	12.0(.472)		6.7(.264)	3.4(.134)			
	8	5/16"	HP-PIT-YF5-8.4E	8.4(.331)	14.0(.551)	30.5(1.201)	11.5(.453)	6.7(.264)	3.4(.134)			

Not so popular size and customized size are available upon requests

WIRE RANGE mm <sup>2</sup> (A.W.G.)	STUD SIZE		ITEM NO.	DIMENSION mm(inch)							PCS/PAC K	UL
	mm	inch		d2	W	L	H	F	D	d1		
0.5-1.5 (22-16)	3.5	#6	HP-PIT-RF1-3.7(6.4)E	3.7(.146)	6.4(.252)	21.0(.827)	10.0(.394)	6.5(.256)	4.3(.169)	1.7(.067)	10*100	
	4	#8	HP-PIT-RF1-4.3(7.2)E	4.3(.169)	7.2(.283)			6.5(.256)	4.3(.169)			
	8	5/16"	HP-PIT-RF1-8.4E	8.4(.331)	12.0(.472)	27.2(1.071)		11.0(.433)	4.3(.169)			
1.5-2.5 (16-14)	3.5	#6	HP-PIT-BF2-3.7(6.0)E	3.7(.146)	6.4(.252)	21.0(.827)	10.0(.394)	6.5(.256)	5.0(.197)	2.3(.091)	10*100	
	3.5	#6	HP-PIT-BF2-3.7(7.2)E	3.7(.146)	7.2(.283)			6.5(.256)	5.0(.197)			
	4	#8	HP-PIT-BF2-4.3(7.2)E	4.3(.169)	7.9(.311)			6.5(.256)	5.0(.197)			
	4	#8	HP-PIT-BF2-4.3(7.9)E	4.3(.169)	7.9(.311)			6.5(.256)	5.0(.197)			
	5	#10	HP-PIT-BF2-5.3(9.3)E	5.3(.209)	9.3(.366)			6.5(.256)	5.0(.197)			
8	5/16"	HP-PIT-BF2-6.4(12.0)E	6.4(.252)	12.0(.472)	27.2(1.071)	11.0(.433)	5.0(.197)					
4-6 (12-10)	4	#8	HP-PIT-YF5-4.3(9.0)E	4.3(.169)	9.0(.354)	25.5(1.004)	13.0(.512)	7.0(.276)	6.7(.264)	3.4(.134)	10*100	

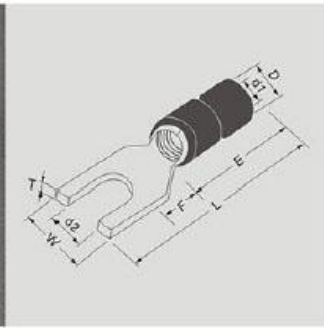

- **Material**
- Insulation: Vinyl
- Terminal Body: Copper
- Metallic Sleeve: Copper
- Plating: Tin
- **Character:**
- Easy Entry
- Better Conduct Connection

## FORK TERMINALS (DIN 46237)

WIRE RANGE mm <sup>2</sup> (A.W.G.)	STUD SIZE		ITEM NO.	DIMENSION mm(inch)							PACK	UL
	mm	inch		d2	W	L	H	F	D	d1		
0.5-1.5 (22-16)	3	#4	HP-PIT-DRF1-3.2E	3.2(.126)	6.0(.236)	18.6(.732)	10.0(.394)	6.0(.236)	4.3(.169)	1.7(.067)	10*100	
	3.5	#6	HP-PIT-DRF1-3.7E	3.7(.146)				6.0(.236)	4.3(.169)	1.7(.067)		
	4	#8	HP-PIT-DRF1-4.3E	4.3(.169)	8.0(.315)	20.6(.811)		7.0(.276))	4.3(.169)	1.7(.067)		
	5	#10	HP-PIT-DRF1-5.3E	5.3(.209)	10.0(.394)	22.6(.890)		8.0(.315)	4.3(.169)	1.7(.067)		
	6	1/4"	HP-PIT-DRF1-6.4E	6.4(.252)	11.0(.433)	25.2(.992)		10.0(.394)	4.3(.169)	1.7(.067)		
1.5-2.5 (16-14)	3	#4	HP-PIT-DBF2-3.2E	3.2(.126)	5.5(.217)	18.6(.732)	10.0(.394)	8.0(.315)	5.0(.197)	2.3(.091)	10*100	
	3.5	#6	HP-PIT-DBF2-3.7E	3.7(.146)	6.0(.236)			6.0(.236)	5.0(.197)	2.3(.091)		
	4	#8	HP-PIT-DBF2-4.3E	4.3(.169)	8.0(.315)	20.6(.811)		7.0(.276))	5.0(.197)	2.3(.091)		
	5	#10	HP-PIT-DBF2-5.3E	5.3(.209)	10.0(.394)	23.6(.929)		9.0(.354)	5.0(.197)	2.3(.091)		
	6	1/4"	HP-PIT-DBF2-6.4E	6.4(.252)	11.0(.433)	26.2(1.031)		11.0(.433)	5.0(.197)	2.3(.091)		
4-6 (12-10)	4	#8	HP-PIT-DYF5-4.3E	4.3(.169)	8.0(.315)	24.2(.953)	13.0(.512)	8.0(.315)	6.7(.264)	3.4(.134)	10*100	
	5	#10	HP-PIT-DYF5-5.3E	5.3(.209)	10.0(.394)	26.4(1.039)		9.0(.354)	6.7(.264)	3.4(.134)		
	6	1/4"	HP-PIT-DYF5-6.4E	6.4(.252)	11.0(.433)	28.2(1.110)		10.0(.394)	6.7(.264)	3.4(.134)		
	8	5/16"	HP-PIT-DYF5-8.4E	8.4(.331)	14.0(.551)	32.6(1.283)		13.0(.512)	6.7(.264)	3.4(.134)		

Not so popular size and customized size are available upon requests

WIRE RANGE mm <sup>2</sup> (A.W.G.)	STUD SIZE		ITEM NO.	DIMENSION mm(inch)							PCS/PACK	UL
	mm	inch		d2	W	L	H	F	D	d1		
0.5-1.5 (22-16)	4	#8	HP-PIT-DRF1-4.3(6.8)E	4.3(.169)	6.8(.268)	20.6(.811)	10.0(.394)	7.0(.276))	4.3(.169)	1.7(.067)	10*100	
1.5-2.5 (16-14)	4	#8	HP-PIT-DBF2-4.3(6.8)E	4.3(.169)	6.8(.268)	20.6(.811)	10.0(.394)	7.0(.276))	5.0(.197)	2.3(.091)	10*100	
4-6 (12-10)	10	3/8"	HP-PIT-DYF5-10.5E	10.5(.413)	18.0(.709)	35.6(1.402)	13.0(.512)	15.0(.591)	6.7(.264)	3.4(.134)	10*100	

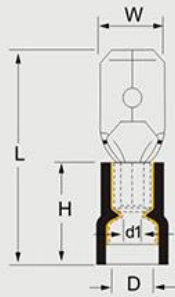

- **Material**
- Insulation: Vinyl
- Terminal Body: Brass
- Metallic Sleeve: Copper
- Plating: Tin
- **Character:**
- Heat Resistance 105°C
- Easy Entry

## MALE TAB TERMINALS

WIRE RANGE mm <sup>2</sup> (A.W.G.)	NEMA TAB Thickness x Width	ITEM NO.	DIMENSION mm(inch)						PACK	UL
			W	L	H	F	C	D		
0.5-1.5 (22-16)	2.8x0.5 .110x.020	HP-PIT-RTAB1-2.8(5)E	2.8(.110)	18.7(.736)	10.0(.394)	6.5(.256)	1.7(.067)	3.9(.154)	10*100	
	2.8x0.8.110x.032	HP-PIT-RTAB1-2.8(8)E				6.5(.256)		3.9(.154)		
	4.8x0.5 .187x.020	HP-PIT-RTAB1-4.8(5)E	4.8(.187)	19.3(.760)		6.7(.264)		3.9(.154)		
	4.8x0.8 .187x.032	HP-PIT-RTAB1-4.8(8)E				6.7(.264)		3.9(.154)		
	6.3x0.8 .250x.032	HP-PIT-RTAB1-6.3(8)E	6.35(.250)	20.8(.819)		7.7(.303)		3.9(.154)		
1.5-2.5 (16-14)	4.8x0.5 .187x.020	HP-PIT-BTAB2-4.8(5)E	4.8(.187)	19.3(.760)	10.0(.394)	6.7(.264)	2.3(.091)	4.7(.185)	10*100	
	4.8x0.8 .187x.032	HP-PIT-BTAB2-4.8(8)E				6.7(.264)		4.7(.185)		
	6.3x0.8 .250x.032	HP-PIT-BTAB2-6.3(8)E	6.35(.250)	20.8(.819)		7.7(.303)		4.7(.185)		
4-6 (12-10)	6.3x0.8 .250x.032	HP-PIT-YTAB5-6.3(8)E	6.35(.250)	24.0(.945)	13.0(.512)	7.7(.303)	3.4(.134)	6.3(.248)	10*100	

Not so popular size and customized Size are available according requests

WIRE RANGE mm <sup>2</sup> (A.W.G.)	NEMA TAB Thickness x Width	ITEM NO.	DIMENSION mm(inch)						PCS/PACK	UL
			W	L	H	F	C	D		
1.5-2.5 (16-14)	2.8x0.5 .110x.020	HP-PIT-BTAB2-2.8(5)E	2.8(.110)	18.7(.736)	10.0(.394)	6.5(.256)	2.3(.091)	4.7(.185)	10*100	
	2.8x0.8.110x.032	HP-PIT-BTAB2-2.8(8)E				6.5(.256)		4.7(.185)		

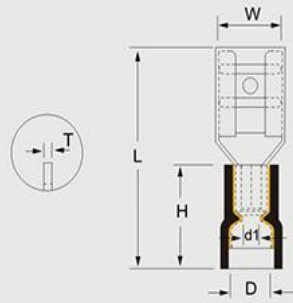

- **Material**
  - Insulation: Vinyl
  - Terminal Body: Brass
  - Metallic Sleeve: Copper
  - Plating: Tin
- **Character:**
  - Easy Entry

## FEMALE SPADE TERMINALS

WIRE RANGE	NEMA TAB	ITEM NO.	DIMENSION mm(inch)						PACK	UL
			W	L	H	F	C	D		
0.5-1.5 (22-16)	2.8x0.5 .110x.020	HP-PIT-RFS1-2.8(5)E	3.2(.126)	18.8(.740)	10.0(.394)	6.4(.252)	1.7(.067)	3.9(.154)	10*100	
	2.8x0.8 .110x.032	HP-PIT-RFS1-2.8(8)E				6.4(.252)		3.9(.154)		
	4.8x0.5 .187x.020	HP-PIT-RFS1-4.8(5)E	5.0(.197)	19.2(.756)		6.4(.252)		3.9(.154)		
	4.8x0.8 .187x.032	HP-PIT-RFS1-4.8(8)E				6.4(.252)		3.9(.154)		
	6.3x0.8 .250x.032	HP-PIT-RFS1-6.3(8)E	6.6(.260)	20.8(.819)		7.2(.283)		3.9(.154)		
1.5-2.5 (16-14)	2.8x0.5 .110x.020	HP-PIT-BFS2-2.8(5)E	3.2(.126)	18.8(.740)	10.0(.394)	6.4(.252)	2.3(.091)	4.7(.185)	10*100	
	2.8x0.8 .110x.032	HP-PIT-BFS2-2.8(8)E				6.4(.252)		4.7(.185)		
	4.8x0.5 .187x.020	HP-PIT-BFS2-4.8(5)E	5.0(.197)	19.2(.756)		6.4(.252)		4.7(.185)		
	4.8x0.8 .187x.032	HP-PIT-BFS2-4.8(8)E				6.4(.252)		4.7(.185)		
	6.3x0.8 .250x.032	HP-PIT-BFS2-6.3(8)E	6.6(.260)	20.8(.819)		7.2(.283)		4.7(.185)		
	8.0x0.8 .312x.032	HP-PIT-BFS2-8.0(8)E	8.2(.323)	24.5(.965)		10.2(.402)		4.7(.185)		
4-6 (12-10)	6.3x0.8 .250x.032	HP-PIT-YFS5-6.3(8)E	6.6(.260)	23.8(.937)	13.0(.512)	7.2(.283)	3.4(.134)	6.3(.248)	10*100	
	9.4x1.2.375x.047	HP-PIT-YFS5-9.4(12)E	10.0(.394)	28.6(1.126)		12.0(.472)		6.3(.248)		

Not so popular size and customized Size are available according requests

WIRE RANGE	NEMA TAB	ITEM NO.	DIMENSION mm(inch)						PCS/PACK	UL
			W	L	H	F	C	D		
0.5-1.5 (22-16)	8.0x0.8 .312x.032	HP-PIT-RFS1-8.0(8)E	8.2(.323)	24.5(.965)	10.0(.394)	10.0(.394)	1.7(.067)	3.9(.154)	10*100	
1.5-2.5 (16-14)	9.4x1.2.375x.047	HP-PIT-BFS2-9.4(12)E	10.0(.394)	25.6(1.008)	10.0(.394)	12.0(.472)	2.3(.091)	4.7(.185)	10*100	

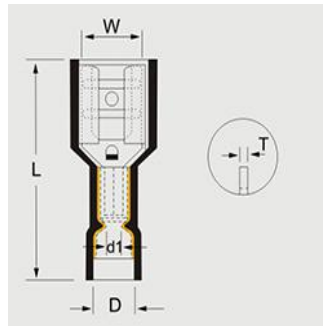

## FEMALE SPADE (FULLY INSULATED) TERMINALS

WIRE RANGE mm <sup>2</sup> (A.W.G.)	NEMA TAB Thickness x Width	ITEM NO.	DIMENSION mm(inch)						PACK	UL
			W	L	H	F	C	D		
0.5-1.5 (22-16)	2.8x0.5 .110x.020	HP-PIT-RFSF1-2.8(5)EO	3.2(.126)	18.8(.740)	10.0(.394)	6.4(.252)	1.7(.067)	3.9(.154)	10*100	
	2.8x0.8 .110x.032	HP-PIT-RFSF1-2.8(8)EO								3.9(.154)
	4.8x0.5 .187x.020	HP-PIT-RFSF1-4.8(5)EO	5.0(.197)	19.2(.756)		6.4(.252)		3.9(.154)		
	4.8x0.8 .187x.032	HP-PIT-RFSF1-4.8(8)EO				6.4(.252)		3.9(.154)		
	6.3x0.8 .250x.032	HP-PIT-RFSF1-6.3(8)EO	6.6(.260)	20.8(.819)		7.2(.283)		3.9(.154)		
	6.3x0.8 .250x.032	HP-PIT-RFSF1-6.3(8)ER				7.2(.283)		3.9(.154)		
1.5-2.5 (16-14)	2.8x0.5 .110x.020	HP-PIT-BFSF2-2.8(5)EO	3.2(.126)	18.8(.740)	10.0(.394)	6.4(.252)	2.3(.091)	4.7(.185)	10*100	
	2.8x0.8 .110x.032	HP-PIT-BFSF2-2.8(8)EO								4.7(.185)
	4.8x0.5 .187x.020	HP-PIT-BFSF2-4.8(5)EO	5.0(.197)	19.2(.756)		6.4(.252)		4.7(.185)		
	4.8x0.8 .187x.032	HP-PIT-BFSF2-4.8(8)EO				6.4(.252)		4.7(.185)		
	6.3x0.8 .250x.032	HP-PIT-BFSF2-6.3(8)EO	6.6(.260)	20.8(.819)		7.2(.283)		4.7(.185)		
	6.3x0.8 .250x.032	HP-PIT-BFSF2-6.3(8)ER				7.2(.283)		4.7(.185)		
4-6 (12-10)	6.3x0.8 .250x.032	HP-PIT-YFSF5-6.3(8)EO	6.6(.260)	23.8(.937)	13.0(.512)	7.2(.283)	3.4(.134)	6.3(.248)	10*100	
	9.4x1.2.375x.047	HP-PIT-YFSF5-9.4(12)EO	10.0(.394)	28.6(1.126)		12.0(.472)		6.3(.248)		

Not so popular size and customized Size are available according requests

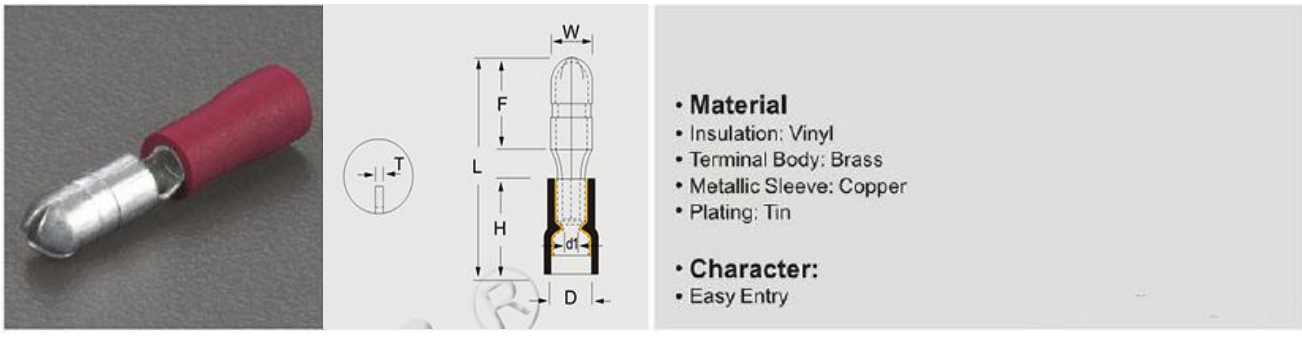

## BULLET TERMINALS

WIRE RANGE mm <sup>2</sup> (A.W.G.)	ITEM NO.	DIMENSION mm(inch)						PCS/PACK	UL
		W	L	H	F	C	D		
0.5-1.5 (22-16)	HP-PIT-RBU1-4E	4.0(.157)	21.0(.827)	10.0(.394)	8.5(.335)	1.7(.067)	3.9(.154)	10*100	
1.5-2.5 (16-14)	HP-PIT-BBU2-4E	4.0(.157)	21.0(.827)	10.0(.394)	8.5(.335)	2.3(.091)	4.7(.185)	10*100	
	HP-PIT-BBU2-5E	5.0(.197)	21.5(.846)		9.0(.354)		4.7(.185)		
4-6 (12-10)	HP-PIT-YBU5-5E	5.0(.197)	24.5(.965)	13.0(.512)	9.0(.354)	3.4(.134)	6.3(.248)	10*100	

Not so popular size and customized Size are available according requests

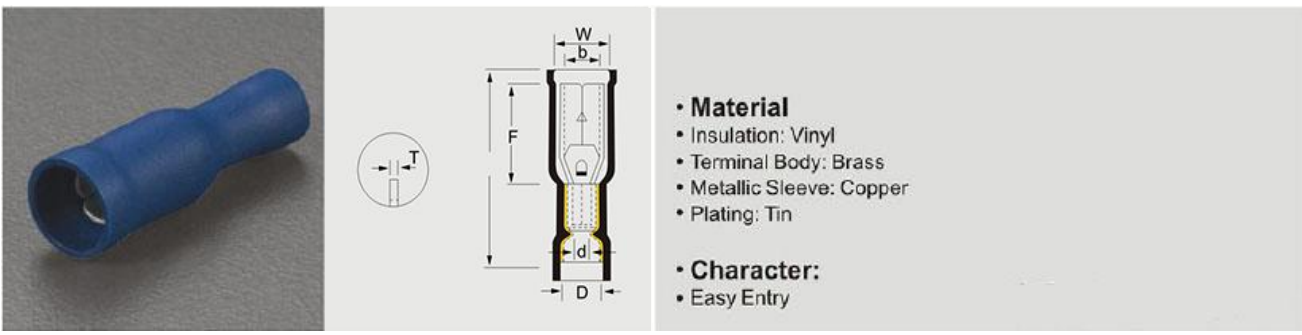

## BULLET RECEPTABLE TERMINALS

WIRE RANGE mm <sup>2</sup> (A.W.G.)	ITEM NO.	DIMENSION mm(inch)						PCS/PACK	COLOR
		W	L	H	F	C	D		
0.5-1.5 (22-16)	HP-PIT-RBR1-4	4.0(.157)	25.0(.984)	10.0(.394)	7.3(.287)	1.7(.067)	3.9(.154)	10*100	
1.5-2.5 (16-14)	HP-PIT-BBR2-4	4.0(.157)	25.0(.984)	10.0(.394)	7.3(.287)	2.3(.091)	4.7(.185)	10*100	
	HP-PIT-BBR2-5	5.0(.197)			8.5(.335)		4.7(.185)		
4-6 (12-10)	HP-PIT-YBR5-5	5.0(.197)	28.0(1.102)	13.0(.512)	8.5(.335)	3.4(.134)	6.3(.248)	10*100	

Not so popular size and customized Size are available according requests

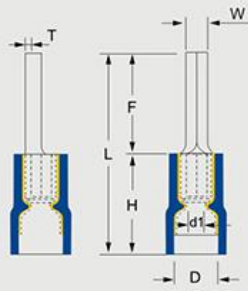

- **Material**
  - Insulation: Vinyl
  - Terminal Body: Copper
  - Metallic Sleeve: Copper
  - Plating: Tin
- **Character:**
  - Easy Entry
  - Better Conduct Connection

## PIN TERMINALS

WIRE RANGE mm <sup>2</sup> (A.W.G.)	ITEM NO.	DIMENSION mm(inch)						PCS/PACK	UL
		W	F	L	H	D	d1		
0.5-1.5 (22-16)	HP-PIT-RP1-9E	1.9(.075)	9.0(.354)	19.0(.748)	10.0(.394)	4.3(.169)	1.7(.067)	10*100	
	HP-PIT-RP1-10E		10.0(.394)	20.0(.787)					
	HP-PIT-RP1-12E		12.0(.472)	22.0(.866)					
1.5-2.5 (16-14)	HP-PIT-BP2-9E	1.9(.075)	9.0(.354)	19.0(.748)	10.0(.394)	5.0(.197)	2.3(.091)	10*100	
	HP-PIT-BP2-10E		10.0(.394)	20.0(.787)					
	HP-PIT-BP2-12E		12.0(.472)	22.0(.866)					
4-6 (12-10)	HP-PIT-YP5-13E	2.8(.110)	14.0(.551)	27.0(1.063)	13.0(.512)	6.7(.264)	3.4(.134)	10*100	

Not so popular size and customized Size are available according requests

WIRE RANGE mm <sup>2</sup> (A.W.G.)	ITEM NO.	DIMENSION mm(inch)						PCS/PACK	UL
		W	F	L	H	D	d1		
0.5-1.5 (22-16)	HP-PIT-RP1-13E	1.9(.075)	13.0(.512)	23.0(.906)	10.0(.394)	4.3(.169)	1.7(.067)	10*100	
1.5-2.5 (16-14)	HP-PIT-BP2-13E	1.9(.075)	13.0(.512)	23.0(.906)	10.0(.394)	5.0(.197)	2.3(.091)	10*100	

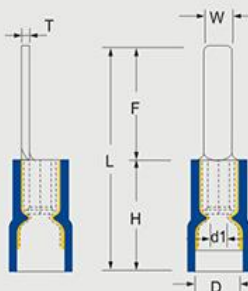

- **Material**
  - Insulation: Vinyl
  - Terminal Body: Copper
  - Metallic Sleeve: Copper
  - Plating: Tin
- **Character:**
  - Easy Entry
  - Better Conduct Connection



**Hampool Enterprise Co., Limited**

上海涵普实业有限公司

## BLADE TERMINALS

WIRE RANGE mm <sup>2</sup> (A.W.G.)	ITEM NO.	DIMENSION mm(inch)						PCS/PACK	UL
		W	F	L	H	D	d1		
0.5-1.5 (22-16)	HP-PIT-RB1-2310E	2.3(.091)	10.0(.394)	20.0(.787)	10.0(.394)	4.3(.169)	1.7(.067)	10*100	
	HP-PIT-RB1-3011E	3.0(.118)	11.0(.433)	21.0(.827)					
	HP-PIT-RB1-3014E		14.0(.551)	24.0(.945)					
	HP-PIT-RB1-2218E	2.2(.087)	18.0(.709)	28.0(1.102)					
1.5-2.5 (16-14)	HP-PIT-BB2-2809E	2.8(.110)	9.0(.354)	19.0(.748)	10.0(.394)	5.0(.197)	2.3(.091)	10*100	
	HP-PIT-BB2-2410E	2.4(.094)	10.0(.394)	20.0(.787)					
	HP-PIT-BB2-2413E		13.0(.512)	23.0(.906)					
	HP-PIT-BB2-2218E	2.2(.079)	18.0(.709)	28.0(1.102)					
4-6 (12-10)	HP-PIT-YB5-2810E	2.8(.110)	10.0(.394)	23.0(.906)	13.0(.512)	6.7(.264)	3.4(.134)	10*100	
	HP-PIT-YB5-4518E	4.5(.177)	18.0(.709)	31.0(1.220)					

Not so popular size and customized Size are available according requests

WIRE RANGE mm <sup>2</sup> (A.W.G.)	ITEM NO.	DIMENSION mm(inch)						PCS/PACK	UL
		W	F	L	H	D	d1		
0.5-1.5 (22-16)	HP-PIT-RB1-2809E	2.8(.110)	9.0(.354)	19.0(.748)	10.0(.394)	4.3(.169)	1.7(.067)	10*100	
	HP-PIT-RB1-2018E	2.0(.079)	18.0(.709)	28.0(1.102)					

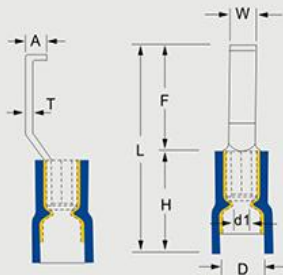
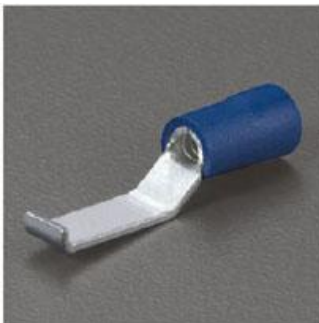

- **Material**
- Insulation: Vinyl
- Terminal Body: Copper
- Metallic Sleeve: Copper
- Plating: Tin
- **Character:**
- Easy Entry
- Better Conduct Connection

## LIPPED BLADE TERMINALS

WIRE RANGE mm <sup>2</sup> (A.W.G.)	ITEM NO.	DIMENSION mm(inch)							PCS/PACK	COLOR
		W	L	H	F	A	D	d1		

Add: Floor 4, Building 12, No. 1755, Wenbei Rd., Nanxiang Town, Jiading District, Shanghai, China. P.C.:201802

Website: [www.hampool.com](http://www.hampool.com)

E-mail: [sales@hampool.com](mailto:sales@hampool.com)

[info@hampool.com](mailto:info@hampool.com)

Tel: +86-21-69927650

Fax: +86-21-69927652

Skype: shrinkproducts



**Hampool Enterprise Co., Limited**

上海涵普实业有限公司

0.5-1.5 (22-16)	HP-PIT-RLB1-3E	3.0(.118)	25.6(1.008)	10.0(.394)	15.6(.614)	2.1(.083)	4.3(.169)	1.7(.067)	10*100	
	HP-PIT-RLB1-4.6E	4.6(.181)								
1.5-2.5 (16-14)	HP-PIT-BLB2-3E	3.0(.118)	25.6(1.008)	10.0(.394)	15.6(.614)	2.1(.083)	5.0(.197)	2.3(.091)	10*100	
	HP-PIT-BLB2-4.6E	4.6(.181)								
4-6 (12-10)	HP-PIT-YLB5-4.6E	4.6(.181)	30.2(1.189)	13.0(.512)	17.2(.677)	2.4(.094)	6.7(.264)	3.4(.134)	10*100	

Not so popular size and customized Size are available according requests

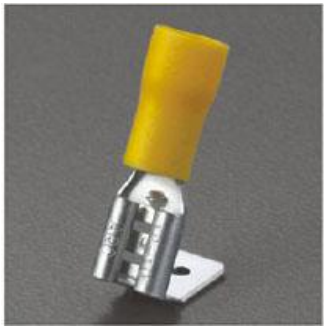

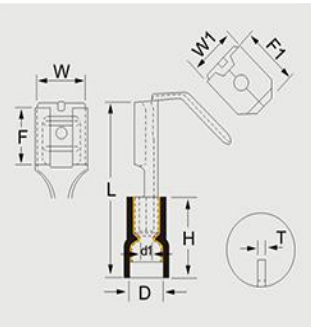

- **Material**
- Insulation: Vinyl
- Terminal Body: Brass
- Metallic Sleeve: Copper
- Plating: Tin
- **Character:**
- Easy Entry

## PIGGY BACK TERMINALS

WIRE RANGE mm <sup>2</sup> (A.W.G.)	NEMA TAB Thickness x Width	ITEM NO.	DIMENSION mm(inch)								PACK	UL
			W	W1	L	F	F1	H	D	d1		
0.5-1.5 (22-16)	6.3x0.8 .250x.032	HP-PIT-RPB1-6.3E	6.6(.260)	6.35(.250)	22.0(.866)	8.0(.315)	8.2(.323)	10.0(.394)	3.9(.154)	1.7(.067)	10*100	
1.5-2.5 (16-14)	6.3x0.8 .250x.032	HP-PIT-BPB2-6.3E	6.6(.260)	6.35(.250)	22.0(.866)	8.0(.315)	8.2(.323)	10.0(.394)	4.7(.185)	2.3(.091)	10*100	
4-6 (12-10)	6.3x0.8 .250x.032	HP-PIT-YPB5-6.3E	6.6(.260)	6.35(.250)	24.5(.965)	8.0(.315)	8.2(.323)	13.0(.512)	6.3(.248)	3.4(.134)	10*100	

Not so popular size and customized Size are available according requests



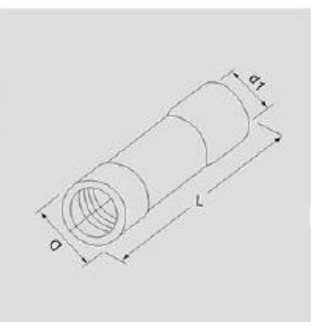

- **Material**
- Insulation: Vinyl
- Terminal Body: Brass
- Metallic Sleeve: Copper
- Plating: Tin
- **Character:**
- Easy Entry

## BUTT CONNECTOR TERMINALS(COPPER)

WIRE RANGE mm <sup>2</sup> (A.W.G.)	ITEM NO.	DIMENSION mm(inch)			PACK	UL
		L	D	d1		
0.5-1.5 (22-16)	HP-PIT-RBCC1E	24.5	4.7(.185)	1.7(.079)	10*100	
1.5-2.5 (16-14)	HP-PIT-BBCC2E	24.5	5.1(.201)	2.3(.102)	10*100	
4-6 (12-10)	HP-PIT-YBCC5E	29.5	6.7(.264)	3.4(.146)	10*100	

Add: Floor 4, Building 12, No. 1755, Wenbei Rd., Nanxiang Town, Jiading District, Shanghai, China. P.C.:201802

Website: [www.hampool.com](http://www.hampool.com)

E-mail: [sales@hampool.com](mailto:sales@hampool.com)

[info@hampool.com](mailto:info@hampool.com)

Tel: +86-21-69927650

Fax: +86-21-69927652

Skype: [shrinkproducts](https://www.skype.com/people/shrinkproducts)



**Hampool Enterprise Co., Limited**

上海涵普实业有限公司

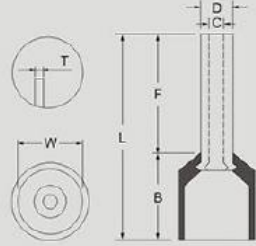

- Material
- Insulation : PVC
- Metal: Copper

## CORD END TERMINAL

Item No.	Dimension(mm)						Lead Section (mm <sup>2</sup> )	Color
	F	L	W	DΦ	CΦ	A.W.G		
HP-VE0.2-6	6.0	10.5	2.5	1.0	0.7	#26	0.25	Light Blue
HP-VE0.2-8	8.0	12.5						Violet
HP-VE0.3-6	6.0	10.5	2.5	1.1	0.8	#24	0.34	Turquoise
HP-VE0.3-8	8.0	12.5						Pink
HP-VE0.5-6	6.0	12.0	2.6	1.3	1.0	#22	0.50	Orange
HP-VE0.5-8	8.0	14.0						White
HP-VE0.5-10	10.0	16.0						
HP-VE0.5-12	12.0	18.0						
HP-VE0.75-6	6.0	12.4	2.8	1.6	1.3	#20	0.75	White
HP-VE0.75-8	8.0	14.6						Blue
HP-VE0.75-10	10.0	16.4						grey
HP-VE0.75-12	12.0	18.4						
HP-VE1-6	6.0	12.4	3.0	1.8	1.5	#18	1.00	Yellow
HP-VE1-8	8.0	14.6						Red
HP-VE1-10	10.0	16.4						
HP-VE1-12	12.0	18.4						
HP-VE1.5-8	6.0	14.6	3.5	2.1	1.8	#16	1.50	Red
HP-VE1.5-10	8.0	16.4						Black
HP-VE1.5-12	10.0	18.4						
HP-VE1.5-18	12.0	24.4						
HP-VE2.5-8	6.0	15.2	4.0	2.6	2.3	#14	2.50	Blue
HP-VE2.5-10	8.0	17.2						Gray
HP-VE2.5-12	10.0	19.2						
HP-VE2.5-18	18.0	25.2						
HP-VE4-9	9.0	16.5	4.4	3.2	2.8	#12	4.00	Gray
HP-VE4-12	12.0	19.5						Orange
HP-VE4-18	18.0	25.5						
HP-VE6-10	10.0	18.0	6.3	3.9	3.5	#10	6.00	Black
HP-VE6-12	12.0	20.0						Green
HP-VE6-18	18.0	26.0						
HP-VE10-12	12.0	21.5	7.6	4.9	4.5	#7	10.00	Ivory
HP-VE10-18	18.0	27.5						Brown

Add: Floor 4, Building 12, No. 1755, Wenbei Rd., Nanxiang Town, Jiading District, Shanghai, China. P.C.:201802

Website: [www.hampool.com](http://www.hampool.com)

E-mail: [sales@hampool.com](mailto:sales@hampool.com)

[info@hampool.com](mailto:info@hampool.com)

Tel: +86-21-69927650

Fax: +86-21-69927652

Skype: shrinkproducts



**Hampool Enterprise Co., Limited**

上海涵普实业有限公司

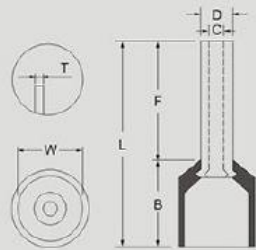

- **Material**
- Insulation : PVC
- Metal: Copper

## CORD END TERMINAL

Item No.	Dimension(mm)						Lead Section (mm <sup>2</sup> )	Color
	F	L	W	DΦ	CΦ	A.W.G		
HP-VE16-12	12.0	22.2	8.8	6.2	5.8	#5	16.00	Green
HP-VE16-18	18.0	28.2						Ivory
HP-E25-16	16.0	29.0	11.2	7.9	7.5	#4	25.0	Brown
HP-VE25-22	22.0	35.0						Black
HP-VE35-16	16.0	30.0	12.7	8.7	8.3	#2	35.0	Beige
HP-VE35-25	25.0	39.0						Red
HP-VE50-20	20.0	36.0	15.3	10.9	10.3	#1	50.0	Turquoise
HP-VE50-25	25.0	41.0						
HP-VE70-20	20.0	37.0	16.0	14.3	13.5	2/0	70.0	Yellow
HP-VE70-25	25.0	42.0						
HP-VE70-27	27.0	44.0						
HP-VE95-25	25.0	44.0	18.5	15.3	14.5	3/0	95.0	Red
HP-VE120-27	27.0	47.0	20.3	17.5	16.5	4/4	120.0	Blue
HP-VE120-32	32.0	52.6						
HP-VE150-25	25.0	50.6	23.4	20.6	19.6	250/300	150.0	Yellow
HP-VE150-27	27.0	52.6						
HP-VE150-32	32.0	57.6						

Add: Floor 4, Building 12, No. 1755, Wenbei Rd., Nanxiang Town, Jiading District, Shanghai, China. P.C.:201802

Website: [www.hampool.com](http://www.hampool.com)

E-mail: [sales@hampool.com](mailto:sales@hampool.com)

[info@hampool.com](mailto:info@hampool.com)

Tel: +86-21-69927650

Fax: +86-21-69927652

Skype: shrinkproducts



**Hampool Enterprise Co., Limited**

上海涵普实业有限公司

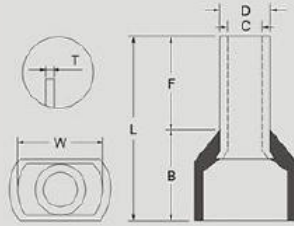

- Material
- Insulation : PVC
- Metal: Copper

## TWIN CORD END TERMINAL

Item No.	Dimension(mm)						Lead Section (mm <sup>2</sup> )	Color
	F	L	W	B	DΦ	CΦ		
HP-VTE0.5-8	8.0	14.5	5.0	6.5	1.8	1.5	2x0.5	White Red
HP-VTE0.75-8	8.0	14.7	5.5	6.7	2.1	1.8	2x0.75	Blue Gray
HP-VTE0.75-10	10.0	16.7	5.5	6.7	2.1	1.8	2x0.75	White
HP-VTE1-8	8.0	15.1	5.5	7.1	2.3	2.0	2x1.0	Red
HP-VTE1-10	10.0	17.1	5.5	7.1	2.3	2.0	2x1.0	Yellow
HP-VTE1.5-8	8.0	15.5	6.4	7.2	2.6	2.3	2x1.5	Black
HP-VTE1.5-12	12.0	19.5	6.4	7.5	2.6	2.3	2x1.5	Red
HP-VTE2.5-10	10.0	18.5	8.0	8.8	3.3	2.9	2x2.5	Gray
HP-VTE2.5-13	13.0	21.5	8.0	8.5	3.3	2.9	2x2.5	Blue
HP-VTE4-12	12.0	23.1	8.8	11.1	4.2	3.8	2x4.0	Orange Grey
HP-VTE6-14	14.0	26.1	9.5	12.1	5.3	4.9	2x6.0	Green Black Yellow
HP-VTE10-14	14.0	26.6	12.6	12.0	6.9	6.5	2x10.0	Brown Ivory Red
HP-VTE16-14	14.0	31.3	19.0	17.3	8.7	8.3	2x16.0	Ivory Green Blue

Add: Floor 4, Building 12, No. 1755, Wenbei Rd., Nanxiang Town, Jiading District, Shanghai, China. P.C.:201802

Website: [www.hampool.com](http://www.hampool.com)

E-mail: [sales@hampool.com](mailto:sales@hampool.com)

[info@hampool.com](mailto:info@hampool.com)

Tel: +86-21-69927650

Fax: +86-21-69927652

Skype: [shrinkproducts](https://www.skype.com/people/shrinkproducts)



**Hampool Enterprise Co., Limited**

上海涵普实业有限公司

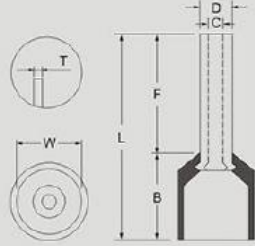

- Material
- Insulation : PP
- Metal: Copper

## CORD END TERMINAL

Item No.	Dimension(mm)						Lead Section (mm <sup>2</sup> )	Color
	F	L	W	DΦ	CΦ	A.W.G		
HP-PPE0.2-6	6.0	10.5	2.5	1.0	0.7	#26	0.25	Light Blue
HP-PPE0.2-8	8.0	12.5						Violet
HP-PPE0.3-6	6.0	10.5	2.5	1.1	0.8	#24	0.34	Turquoise
HP-PPE0.3-8	8.0	12.5						Pink
HP-PPE0.5-6	6.0	12.0	2.6	1.3	1.0	#22	0.50	Orange
HP-PPE0.5-8	8.0	14.0						White
HP-PPE0.5-10	10.0	16.0						
HP-PPE0.5-12	12.0	18.0						
HP-PPE0.75-6	6.0	12.4	2.8	1.6	1.3	#20	0.75	White
HP-PPE0.75-8	8.0	14.6						Blue
HP-PPE0.75-10	10.0	16.4						grey
HP-PPE0.75-12	12.0	18.4						
HP-PPE1-6	6.0	12.4	3.0	1.8	1.5	#18	1.00	Yellow
HP-PPE1-8	8.0	14.6						Red
HP-PPE1-10	10.0	16.4						
HP-PPE1-12	12.0	18.4						
HP-PPE1.5-8	6.0	14.6	3.5	2.1	1.8	#16	1.50	Red
HP-PPE1.5-10	8.0	16.4						Black
HP-PPE1.5-12	10.0	18.4						
HP-PPE1.5-18	12.0	24.4						
HP-PPE2.5-8	6.0	15.2	4.0	2.6	2.3	#14	2.50	Blue
HP-PPE2.5-10	8.0	17.2						Gray
HP-PPE2.5-12	10.0	19.2						
HP-PPE2.5-18	18.0	25.2						
HP-PPE4-9	9.0	16.5	4.4	3.2	2.8	#12	4.00	Gray
HP-PPE4-12	12.0	19.5						Orange
HP-PPE4-18	18.0	25.5						
HP-PPE6-10	10.0	18.0	6.3	3.9	3.5	#10	6.00	Black
HP-PPE6-12	12.0	20.0						Green
HP-PPE6-18	18.0	26.0						
HP-PPE10-12	12.0	21.5	7.6	4.9	4.5	#7	10.00	Ivory
HP-PPE10-18	18.0	27.5						Brown

Add: Floor 4, Building 12, No. 1755, Wenbei Rd., Nanxiang Town, Jiading District, Shanghai, China. P.C.:201802

Website: [www.hampool.com](http://www.hampool.com)

E-mail: [sales@hampool.com](mailto:sales@hampool.com)

[info@hampool.com](mailto:info@hampool.com)

Tel: +86-21-69927650

Fax: +86-21-69927652

Skype: shrinkproducts



**Hampool Enterprise Co., Limited**

上海涵普实业有限公司

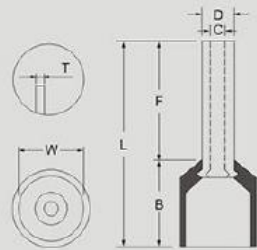

- **Material**
- Insulation : PP
- Metal: Copper

## CORD END TERMINAL

Item No.	Dimension(mm)						Lead Section (mm <sup>2</sup> )	Color
	F	L	W	DΦ	CΦ	A.W.G		
HP-PPE16-12	12.0	22.2	8.8	6.2	5.8	#5	16.00	Green
HP-PPE16-18	18.0	28.2						Ivory
HP-PPE25-16	16.0	29.0	11.2	7.9	7.5	#4	25.0	Brown
HP-PPE25-22	22.0	35.0						Black
HP-PPE35-16	16.0	30.0	12.7	8.7	8.3	#2	35.0	Beige
HP-PPE35-25	25.0	39.0						Red
HP-PPE50-20	20.0	36.0	15.3	10.9	10.3	#1	50.0	Turquoise
HP-PPE50-25	25.0	41.0						
HP-PPE70-20	20.0	37.0	16.0	14.3	13.5	2/0	70.0	Yellow
HP-PPE70-25	25.0	42.0						
HP-PPE70-27	27.0	44.0						
HP-PPE95-25	25.0	44.0	18.5	15.3	14.5	3/0	95.0	Red
HP-PPE120-27	27.0	47.0	20.3	17.5	16.5	4/4	120.0	Blue
HP-PPE120-32	32.0	52.6						
HP-PPE150-25	25.0	50.6	23.4	20.6	19.6	250/300	150.0	Yellow
HP-PPE150-27	27.0	52.6						
HP-PPE150-32	32.0	57.6						

Add: Floor 4, Building 12, No. 1755, Wenbei Rd., Nanxiang Town, Jiading District, Shanghai, China. P.C.:201802

Website: [www.hampool.com](http://www.hampool.com)

E-mail: [sales@hampool.com](mailto:sales@hampool.com)

[info@hampool.com](mailto:info@hampool.com)

Tel: +86-21-69927650

Fax: +86-21-69927652

Skype: shrinkproducts

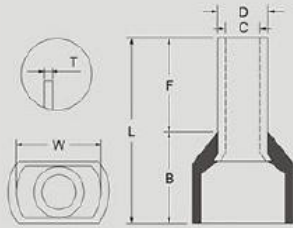

- **Material**
- Insulation : PP
- Metal: Copper

## TWIN CORD END TERMINAL

Item No.	Dimension(mm)						Lead Section (mm <sup>2</sup> )	Color
	F	L	W	B	DΦ	CΦ		
HP-PPTE0.5-8	8.0	14.5	5.0	6.5	1.8	1.5	2x0.5	White Red
HP-PPTE0.75-8	8.0	14.7	5.5	6.7	2.1	1.8	2x0.75	Blue Gray
HP-PPTE0.75-10	10.0	16.7	5.5	6.7	2.1	1.8	2x0.75	White
HP-PPTE1-8	8.0	15.1	5.5	7.1	2.3	2.0	2x1.0	Red
HP-PPTE1-10	10.0	17.1	5.5	7.1	2.3	2.0	2x1.0	Yellow
HP-PPTE1.5-8	8.0	15.5	6.4	7.2	2.6	2.3	2x1.5	Black
HP-PPTE1.5-12	12.0	19.5	6.4	7.5	2.6	2.3	2x1.5	Red
HP-PPTE2.5-10	10.0	18.5	8.0	8.8	3.3	2.9	2x2.5	Gray
HP-PPTE2.5-13	13.0	21.5	8.0	8.5	3.3	2.9	2x2.5	Blue
HP-PPTE4-12	12.0	23.1	8.8	11.1	4.2	3.8	2x4.0	Orange Grey
HP-PPTE6-14	14.0	26.1	9.5	12.1	5.3	4.9	2x6.0	Green Black Yellow
HP-PPTE10-14	14.0	26.6	12.6	12.0	6.9	6.5	2x10.0	Brown Ivory Red
HP-PPTE16-14	14.0	31.3	19.0	17.3	8.7	8.3	2x16.0	Ivory Green Blue

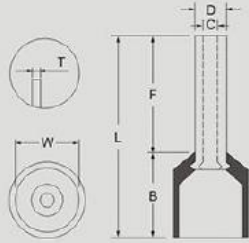

- Material
- Insulation : Nylon
- Metal: Copper

### CORD END TERMINAL

Item No.	Dimension(mm)						Lead Section (mm <sup>2</sup> )	Color
	F	L	W	DΦ	CΦ	A.W.G		
HP-PAE0.2-6	6.0	10.5	2.5	1.0	0.7	#26	0.25	Light Blue
HP-PAE0.2-8	8.0	12.5						Violet
HP-PAE0.3-6	6.0	10.5	2.5	1.1	0.8	#24	0.34	Turquoise
HP-PAE0.3-8	8.0	12.5						Pink
HP-PAE0.5-6	6.0	12.0	2.6	1.3	1.0	#22	0.50	Orange
HP-PAE0.5-8	8.0	14.0						White
HP-PAE0.5-10	10.0	16.0						
HP-PAE0.5-12	12.0	18.0						
HP-PAE0.75-6	6.0	12.4	2.8	1.6	1.3	#20	0.75	White
HP-PAE0.75-8	8.0	14.6						Blue
HP-PAE0.75-10	10.0	16.4						grey
HP-PAE0.75-12	12.0	18.4						
HP-PAE1-6	6.0	12.4	3.0	1.8	1.5	#18	1.00	Yellow
HP-PAE1-8	8.0	14.6						Red
HP-PAE1-10	10.0	16.4						
HP-PAE1-12	12.0	18.4						
HP-PAE1.5-8	6.0	14.6	3.5	2.1	1.8	#16	1.50	Red
HP-PAE1.5-10	8.0	16.4						Black
HP-PAE1.5-12	10.0	18.4						
HP-PAE1.5-18	12.0	24.4						
HP-PAE2.5-8	6.0	15.2	4.0	2.6	2.3	#14	2.50	Blue
HP-PAE2.5-10	8.0	17.2						Gray
HP-PAE2.5-12	10.0	19.2						
HP-PAE2.5-18	18.0	25.2						
HP-PAE4-9	9.0	16.5	4.4	3.2	2.8	#12	4.00	Gray
HP-PAE4-12	12.0	19.5						Orange
HP-PAE4-18	18.0	25.5						
HP-PAE6-10	10.0	18.0	6.3	3.9	3.5	#10	6.00	Black
HP-PAE6-12	12.0	20.0						Green
HP-PAE6-18	18.0	26.0						
HP-PAE10-12	12.0	21.5	7.6	4.9	4.5	#7	10.00	Ivory
HP-PAE10-18	18.0	27.5						Brown

Add: Floor 4, Building 12, No. 1755, Wenbei Rd., Nanxiang Town, Jiading District, Shanghai, China. P.C.:201802

Website: [www.hampool.com](http://www.hampool.com)

E-mail: [sales@hampool.com](mailto:sales@hampool.com)

[info@hampool.com](mailto:info@hampool.com)

Tel: +86-21-69927650

Fax: +86-21-69927652

Skype: shrinkproducts



**Hampool Enterprise Co., Limited**

上海涵普实业有限公司

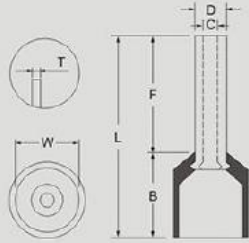

- **Material**
- Insulation : Nylon
- Metal: Copper

## CORD END TERMINAL

Item No.	Dimension(mm)						Lead Section (mm <sup>2</sup> )	Color
	F	L	W	DΦ	CΦ	A.W.G		
HP-PAE16-12	12.0	22.2	8.8	6.2	5.8	#5	16.00	Green
HP-PAE16-18	18.0	28.2						Ivory
HP-PAE25-16	16.0	29.0	11.2	7.9	7.5	#4	25.0	Brown
HP-PAE25-22	22.0	35.0						Black
HP-PAE35-16	16.0	30.0	12.7	8.7	8.3	#2	35.0	Beige
HP-PAE35-25	25.0	39.0						Red
HP-PAE50-20	20.0	36.0	15.3	10.9	10.3	#1	50.0	Turquoise
HP-PAE50-25	25.0	41.0						
HP-PAE70-20	20.0	37.0	16.0	14.3	13.5	2/0	70.0	Yellow
HP-PAE70-25	25.0	42.0						
HP-PAE70-27	27.0	44.0						
HP-PAE95-25	25.0	44.0	18.5	15.3	14.5	3/0	95.0	Red
HP-PAE120-27	27.0	47.0	20.3	17.5	16.5	4/4	120.0	Blue
HP-PAE120-32	32.0	52.6						
HP-PAE150-25	25.0	50.6	23.4	20.6	19.6	250/300	150.0	Yellow
HP-PAE150-27	27.0	52.6						
HP-PAE150-32	32.0	57.6						

Add: Floor 4, Building 12, No. 1755, Wenbei Rd., Nanxiang Town, Jiading District, Shanghai, China. P.C.:201802

Website: [www.hampool.com](http://www.hampool.com)

E-mail: [sales@hampool.com](mailto:sales@hampool.com)

[info@hampool.com](mailto:info@hampool.com)

Tel: +86-21-69927650

Fax: +86-21-69927652

Skype: shrinkproducts



**Hampool Enterprise Co., Limited**

上海涵普实业有限公司

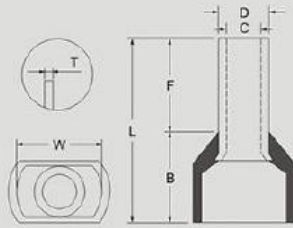

- **Material**
- Insulation : Nylon
- Metal: Copper

## TWIN CORD END TERMINAL

Item No.	Dimension(mm)						Lead Section (mm <sup>2</sup> )	Color
	F	L	W	B	DΦ	CΦ		
HP-PATE0.5-8	8.0	14.5	5.0	6.5	1.8	1.5	2x0.5	White Red
HP-PATE0.75-8	8.0	14.7	5.5	6.7	2.1	1.8	2x0.75	Blue Gray
HP-PATE0.75-10	10.0	16.7	5.5	6.7	2.1	1.8	2x0.75	White
HP-PATE1-8	8.0	15.1	5.5	7.1	2.3	2.0	2x1.0	Red
HP-PATE1-10	10.0	17.1	5.5	7.1	2.3	2.0	2x1.0	Yellow
HP-PATE1.5-8	8.0	15.5	6.4	7.2	2.6	2.3	2x1.5	Black
HP-PATE1.5-12	12.0	19.5	6.4	7.5	2.6	2.3	2x1.5	Red
HP-PATE2.5-10	10.0	18.5	8.0	8.8	3.3	2.9	2x2.5	Gray
HP-PATE2.5-13	13.0	21.5	8.0	8.5	3.3	2.9	2x2.5	Blue
HP-PATE4-12	12.0	23.1	8.8	11.1	4.2	3.8	2x4.0	Orange Grey
HP-PATE6-14	14.0	26.1	9.5	12.1	5.3	4.9	2x6.0	Green Black Yellow
HP-PATE10-14	14.0	26.6	12.6	12.0	6.9	6.5	2x10.0	Brown Ivory Red
HP-PATE16-14	14.0	31.3	19.0	17.3	8.7	8.3	2x16.0	Ivory Green Blue

Add: Floor 4, Building 12, No. 1755, Wenbei Rd., Nanxiang Town, Jiading District, Shanghai, China. P.C.:201802

Website: [www.hampool.com](http://www.hampool.com)

E-mail: [sales@hampool.com](mailto:sales@hampool.com)

[info@hampool.com](mailto:info@hampool.com)

Tel: +86-21-69927650



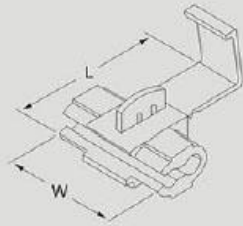

Fax: +86-21-69927652

Skype: [shrinkproducts](https://www.skype.com/people/shrinkproducts)



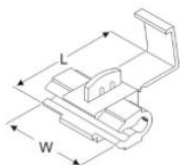

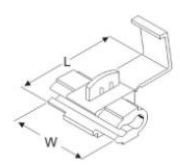

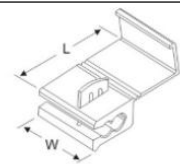

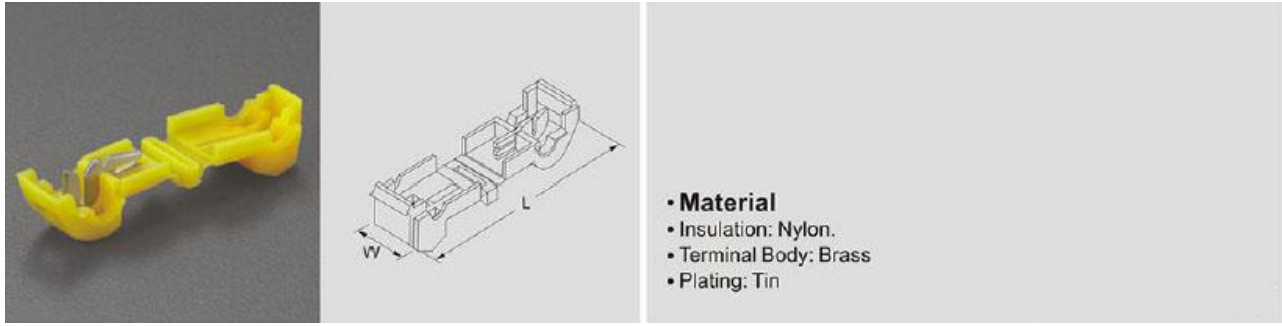

- **Material**
- Insulation: P.P.
- Terminal Body: Brass
- Plating: Tin

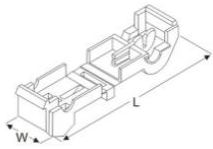
## QUICK SPLICE CONNECTORS

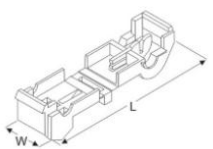
Picture	Item No.	Dimension(mm)		A.W.G (mm <sup>2</sup> )	Color	Figure
		W	L			
	HP-RQC1	20.0	27.0	22-18(0.5-1.0)	Red	
	HP-BQC2	20.0	27.0	18-14(0.75-2.5)	Blue	
	HP-YQC5	20.5	34.5	12-10(4-6)	Yellow	

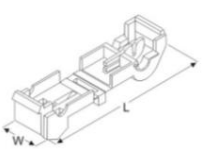

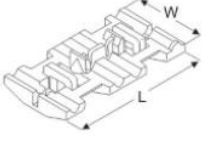
## QUICK SPLICE CONNECTORS

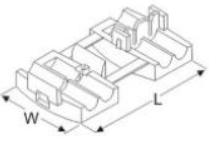
Picture	Item No.	Dimension(mm)		A.W.G (mm <sup>2</sup> )	Color	Figure
		W	L			
	HP-RTC1	9.8	37.0	22-18(0.5-0.75)	Tan	
	HP-BTC2	9.8	37.0	18-14(0.75-2.5)	Blue	
	HP-YTC5	9.8	37.0	12-10(4)	Yellow	
	HP-RCC1	35.0	34.0	22-18(0.75-1.5)	Red	
	HP-BCC2	35.0	34.0	18-14(0.75-2.5)	Blue	

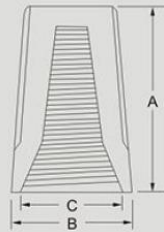

- **Material**
- Insulation: Nylon
- Metal: Copper Tube

## WIRE NUT CONNECTOR

SUITABLE WIRE mm <sup>2</sup> (A.W.G.)	ITEM NO.	DIMENSION mm(inch)			PCS/PACK	COLOR
		B	C	A		
Min. 0.75×1+0.5×1 (20×1+22×1) Max. 1.5×2 (16×2)	HP-SP1	8.5(.335)	6.7(.264)	15.0(.591)	1000	Grey
Min. 0.75×3 (20×3) Max. 1.5×3(16×3)	HP-SP2	10.1(.398)	7.4(.291)	17.5(.689)	1000	Blue
Min. 0.75×3 (20×3) Max. 1.5×3+1×1 (16×3+18×1)	HP-SP3	12.5(.492)	9.9(.390)	22.1(.870)	500	Orange
Min.2.5×1+0.75×1 (14×1+20×1) Max. 2.5×4+0.75×1 (14×4+20×1)	HP-SP4	13.7(.539)	11.0(.433)	24.5(.965)	500	Yellow
Min. 2.5×2 (14×2) Max. 6.0×2+4.0×2 (10×2+12×2)	HP-SP6	16.0(.630)	13.0(.512)	26.5(1.043)	250	Red

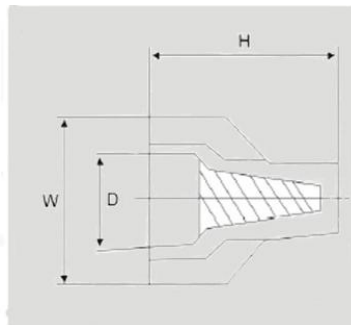

- **Material**
- Insulation: Nylon
- Metal: Copper Tube

## WIRE NUT CONNECTOR ( Wing Type with Spring Insert)

SUITABLE WIRE mm <sup>2</sup> (A.W.G.)	ITEM NO.	DIMENSION mm(inch)			PCS/PACK	COLOR
		H	W	D		
1.0-6.0 (18-10)	HP-HP11	25.4(1.000)	18(.709)	10(.394)	500	Yellow
0.5-8 (22-8)	HP-HP12	27.8(1.094)	17.8(.701)	10(.394)	500	Pink
1.0-8.0 (18-8)	HP-HP13	30.5(1.201)	23.1(.909)	12(.472)	250	Red
1.0-8.0 (18-8)	HP-HP15	32.6(1.283)	25.5(1.004)	14.5(.571)	250	Grey
2.5-10 (14-6)	HP-HP17	39.5(1.555)	31.7(1.248)	17.8(.701)	250	Blue



**Hampool Enterprise Co., Limited**

上海涵普实业有限公司

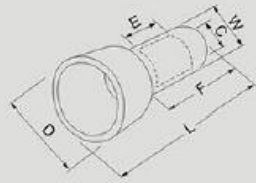

- **Material**
- Insulation: Nylon
- Terminal Body: Copper
- Plating: Tin

## CLOSE END CONNECTORS

WIRE RANGE mm <sup>2</sup> (A.W.G.)	ITEM NO.	DIMENSION mm(inch)					PCS/PACK	COLOR
		W	L	D	T	C		
0.5-1.5 (22-16)	HP-CE(N)1	5.0(.197)	21.0(.827)	8.0(.315)	0.5(.020)	2.3(.091)	500	Nature
1.5-2.5 (16-14)	HP-CE(N)2	5.5(.217)	21.0(.827)	8.0(.315)	0.45(.018)	3.1(.122)	500	
4-6 (12-10)	HP-CE(N)5	7.5(.295)	25.5(1.004)	10.0(.394)	0.7(.028)	4.0(.157)	500	

Add: Floor 4, Building 12, No. 1755, Wenbei Rd., Nanxiang Town, Jiading District, Shanghai, China. P.C.:201802

Website: [www.hampool.com](http://www.hampool.com)

E-mail: [sales@hampool.com](mailto:sales@hampool.com)

[info@hampool.com](mailto:info@hampool.com)

Tel: +86-21-69927650

Fax: +86-21-69927652

Skype: shrinkproducts